

GAME DESIGN RESEARCH

AN INTRODUCTION TO THEORY & PRACTICE

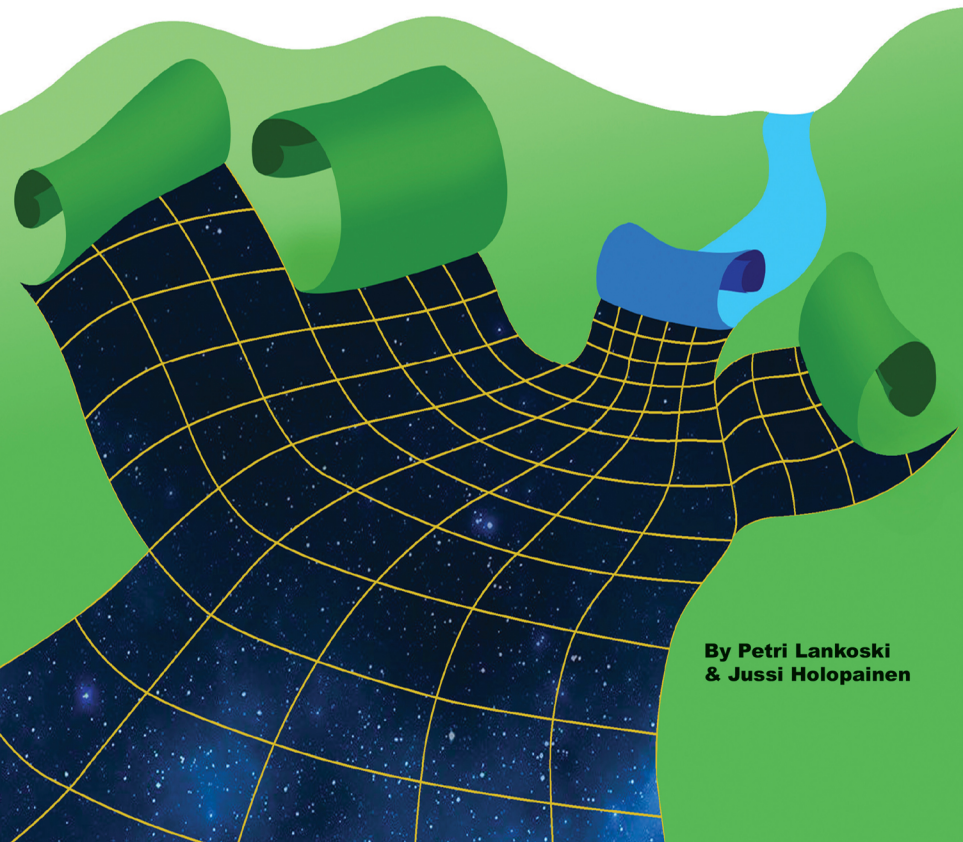

**By Petri Lankoski
& Jussi Holopainen**

GAME DESIGN RESEARCH

GAME DESIGN RESEARCH

An Introduction to Theory & Practice

Petri Lankoski & Jussi Holopainen

Carnegie Mellon University: ETC Press

Pittsburgh, PA



Game Design Research by ETC Press is licensed under a Creative Commons Attribution-NonCommercial-NoDerivatives 4.0 International License, except where otherwise noted.

Copyright © by ETC Press 2017 <http://press.etc.cmu.edu/>

ISBN 978-1-387-40836-8 (Print)

ISBN 978-1-387-40837-5 (Digital)

TEXT: The text of this work is licensed under a Creative Commons Attribution-NonCommercial-NonDerivative 2.5 License (<http://creativecommons.org/licenses/by-nc-nd/2.5/>)

IMAGES: All images appearing in this work are property of the respective copyright owners, and are not released into the Creative Commons. The respective owners reserve all rights.

CONTENTS

Game design research	1
An overview	
<i>Petri Lankoski and Jussi Holopainen</i>	
1. Epistemological underpinnings of game design research	15
<i>Laureline Chiapello</i>	
2. Multidisciplinary game design research	35
Ontologies and other remarks	
<i>Annakaisa Kultima</i>	
3. De-coding games through historical research in art and design	51
<i>Christopher W. Totten</i>	
4. Investigating game design methods and models	75
<i>Joris Dormans and Jussi Holopainen</i>	
5. Games design research through game design practice	97
<i>Paul Coulton and Alan Hook</i>	
6. Game design mise-en-scène practice	117
Intention and means in JEU SERAI	
<i>Emmanuel Guardiola and Stéphane Natkin</i>	
7. Gaps of uncertainty	135
A case for experimentation in serious game design frameworks	
<i>Niels Quinten, Steven Malliet and Karin Coninx</i>	
8. Experimental game design	157
<i>Annika Waern & Jon Back</i>	
9. Going indie	171
Methods for understanding indie production	
<i>Alyea Sandovar</i>	
10. Critical practices in game design	199
<i>Jess Marcotte and Rilla Khaled</i>	
 <i>About the Authors</i>	 219
<i>About the ETC Press</i>	223

GAME DESIGN RESEARCH

AN OVERVIEW

PETRI LANKOSKI AND JUSSI HOLOPAINEN

Game design aims to solve a design problem of “how do we create this specific game?” The main goal of this process is a game; new understanding about game development and game design is merely a by-product of that process. In *game design research* the aim is to uncover new facts and insight about game design, design processes, or games as designed objects; that is, to gain new knowledge and understanding about game design. *Game research*, on the other hand, is an umbrella term for all kinds of research studying games (as artifacts), play, or players (cf. Lankoski and Björk, 2015b)

Design research, or design studies as it is also called, has been gaining momentum since the beginning of 20th century, although its history can be traced back millennia (e.g., Aristotle’s *Poetics*, circa 335 BCE and Vitruvius’ *De architectura* circa 15 BCE). While the history of games is long, little is known about the design of early games. Some information about evolution of certain games exists (e.g., Parker, 2006). Elizabeth Magie’s *Landlord’s game* (1903) is one of the early examples where there is data about its design, such as that the game is designed based on an economical theory by Henry George.

The first well-known publication about computer game design was in the 1980s when Chris Crawford (1984) published his seminal *The art of game design*. However, *Simulation & Gaming* journal has been publishing about using games in research and education from the early 1970s (for example, Nagazawa, 1970). The history of business simulation games is even longer (cf. Faria et al., 2009). *Game developer* magazine (1994–2013) published postmortems of game development, quality control, design, game art and musics, and programming. Game development came into the spotlight in the 2000s when multiple books about game design were published (e.g., Salen and Zimmerman, 2003) and Digital Game Research Association (DiGRA) conferences provided a venue for game research and began publishing design research (e.g., Lankoski and Heliö, 2002; Martin et al., 2003; Björk, Lundgren and Holopainen, 2003).

For the purpose of the following discussion, Nigel Cross’ (1999) definition of design research as “development, articulation and communication of design knowledge” (p.5) is used. However, one needs to remember that a key aspect of research is that research is a systematic practice. Cross argues further that the design knowledge resides in people, processes, and artifacts resulting in three different domains of design knowledge: *design epistemology* (the study of designerly ways of knowing), *design praxiology* (the study of practices and processes of design) and *design phenomenology* (the study of the form and function of the resulting artifacts).

The studies in game design research can be positioned accordingly. The game design epistemology is concerned with what kinds of knowledge game designers have and employ in their design practice. Investigations of explicit and implicit conceptual design frameworks and studies of how designers use examples from existing games to frame design situations are part of game design epistemology (cf. Chiapello, this volume). The design practices and processes, both actual and prescribed, are the focus of design praxiology. How designers work, what kinds of methods and design tools they use, and how

game design is situated in the larger game development are examples of these studies. The design phenomenology has, perhaps, been the most prevalent form of game design research and covers many issues in the more general game research field such as analyses and impact studies of games.

Another useful way to make sense of the complex field of design research is to categorize it according to the goals and approaches used in the studies. Forlizzi, et al. (2009; cf. Frayling, 1993; Coulton and Hook, this volume) propose three categories: research on (or about) design, research for design, and research through design. Research on design aims to understand design as a specific human activity, including aspects such as design cognition, the role of specific activities such as sketching in design, and creativity (e.g., Holopainen, Nummenmaa and Kuittinen, 2010). The goals in research for design are to develop theories and knowledge which can be applied in the practical design work. Forlizzi, et al. (2009) list conceptual frameworks, guiding philosophies, and design implications as examples of research for design (cf. Chiapello, this volume; Dormans and Holopainen, this volume; Back and Waern, this volume). Research through design, on the other hand, is an approach to produce different kinds of design knowledge, including conceptual frameworks and design theories. As the name implies the outputs are developed through actively engaging in producing designed artifacts.

A persistent form of game design research is aiming to understand design practices or improve those practices, in other words, research for design. Game design research, however, is not only about improving existing design practices as is evident from the historical overview of game design research below. What we provide in the following discussion is not a systematic review of history of game design research, but rather an overview reflecting our histories as game design research practitioners.

AUTOBIOGRAPHICAL APPROACHES

Initial takes on game design research were typically informal or ad hoc. The driving force at the beginning was the designers' need to better understand what they were doing and to learn from their previous work. Data about development was typically not gathered systematically and autobiographical design experiences were an important part of analytical reflections.

The roots of game design research are in informal¹ inquiries where designers started to ask how to design better games. Early examples of theorising about design include Jackson and Schuessler' (1981) work on board game design in *Game design: Volume 1: Theory & practice* and Crawford's (1984) description on development process along with design techniques and design norms in his *The art of computer game design*. Notably, Schuessler (in Jackson and Schuessler, 1981) uses game theory in his approach to board game design.

The discussion focussed on what is a good game and how to design those kinds of games. Design approaches are driven by norms. The following quote is an example of norms and assumptions in game design derived from an implicit understanding of what makes a good game:

Because game players become their characters, game writers should confine themselves to single-person, limited point of view. This means that the player should never be shown or told anything that the character has not experienced directly. (Laramée, 2002, p.266)

Norms and heuristics, as Niiniluoto (1993) points out, are essential for design work. The norms are (at least to some degree) a matter of taste. Norms for a game appealing to children may be quite different

1. Informal is used to denote approaches where the presented results are not a result based on systematic investigation of a topic using a method to study the topic.

from the norms of a game appealing to adults. Changing the norms of a good game leads to a different set of design recommendations. For example, *Witcher 3: Wild hunt* (CD Project RED, 2015) was a very successful and popular game even though it breaks Laramée's aforementioned design principles when the game switches between Geralt and Ciri. It is worth to emphasize that immersion as a design norm is not wrong, but the norm tends to promote certain design directions and demote other types of design solutions.

Designers and developers actively publish about different approaches to game development. *Game developer conference*, *Game developer* magazine (1994–2013), and *Gamasutra* (1997–) magazine have been prominent venues for sharing experiences of design processes (called Postmortems following Crawford's, 1984, terminology) and advices for best practice. More practice informed design theory and method approaches started to surface in the 2000s (e.g., Rouse, 2001; Schell, 2008). Some works are creating connections to different areas of design: Sheldon (2004) draws from dramatic writing and Totten (2014) from architecture.

Non-digital entertainment games have also been discussed by practitioners. For example, Knizia's (2010) *Dice games properly explained* discusses mainly dice games from the player perspective (e.g., good strategies), but also covers design of dice games. There are vibrant hobby communities around board and roleplaying games such as *Boardgame geek* (boardgamegeek.com), *Board game designer forum* (www.bgdf.com), *RPGNet* (www.rpg.net), and the LARP focused *Knutepunkt/Solmukohta*². The design oriented discussions within these communities are often based on the designers' own reflections on their design work and sometimes lack the analytical rigour. There are, however, exceptions, especially in the books published from Knutepunkt/Solmukohta conference series.

COMPARATIVE AND CONCEPTUAL APPROACHES

The next shift happened at 1990s when to focus moved from postmortems to developing approaches to describe games. In these approaches playing games produces the data that is analysed (cf. Cross, 1999, design epistemology, praxiology, and phenomenology) to develop models, concepts, and definitions of games. Researchers and practitioners also took up the quest of defining a language to describe games. The lack of language to discuss and describe game design has been an issue for a long time. Greg Costikyan (1994) tackles the issue that game designers do not have a language to discuss and describe game design in the essay *I have no words & I must design* in the context of table-top roleplaying games

In his essay, Costikyan (1994) discusses what a game is and what makes a good game based on the criteria of his definition. His definition is meant to highlight the designable aspects and provide some criteria to evaluate different design decisions against the criteria of a good game. This descriptive approach along with earlier ones (Crawford, 1984, provides a definition and a taxonomy of games) are based on the needs of game designers to understand what they are designing.

As noted above, game designers have been concerning themselves with the question what is *game* and language to discuss game design. This form of game design research is closely connected, or indistinguishable, from game research that is looking at the questions about what games are. Elliot M. Avedon and Brian Sutton-Smith's (1971) *The study of games* from 1971 is an early example where (sport, gambling) games and children's play are regarded as artifacts, not merely as an abstract cultural category.

2. *Knutepunkt/Solmukohta* is a yearly conference for live-action role-players and designers.

Salen and Zimmerman (2003), in *Rules of play*, Hunicke, et al. (2004) in *MDA*, and Elias, et al. (2012), in *Characteristics of games*, take a more theoretically driven approach when describing different kinds of theories and their applications to game design. Notably, Elias, et al., are focusing on board and card games in their work. Salen and Zimmerman look at games as information systems, cybernetic systems, and so on whereas Elias, et al., draw much from game theory. Hunicke, et al. present a formal analysis framework breaking games to mechanic, dynamic and aesthetic components. Salen and Zimmerman, Hunicke, et al., and Elias, et al., also provide analyses of games and play behaviors in order to provide tools to think about game design in more structured ways. In a similarly structured manner, Klabbers (2008) presents principles of the design and use of games where he connects simulation game design, a scientific tradition set-up by the *Simulation & Gaming* journal (1970–), to the various other domains of game design.

Björk and Holopainen (Björk, Lundgren and Holopainen, 2003; Björk and Holopainen, 2005) introduced their game design patterns approach for describing formal structures of games. They based the pattern language on the architectural design patterns by Alexander et al. (1977). Lankoski and Björk (2015a) draw on formal art analysis to provide concepts and a method to describe and analyse games. Zagal's, et al. (2005) game ontology project aimed to provide tools for describing and analysing games using Lakoff (1987) prototype theory as a premise to build their ontology. Aki Järvinen (2008) and Joris Dormans (2012) present detailed theories on game systems and sketch theories for the relation of game system and play experience in their doctoral theses.

Totten (in this volume) traces game design via looking at games, applying historical approach from the architectural research. Bateman and Zagal (2017) track the evolution of game design features such as inventory systems.

The above review of conceptual approaches reveal a range of different approaches for describing games systems. The plurality of frameworks indicates that there is still little agreement on how to conceptualize game systems.

RESEARCH THROUGH DESIGN

Research through design has been an eminent approach in game design research beginning from the early days of *Simulation & Gaming* journal through Thomas Malone's (1981; 1982) seminal work in early 1980s and Brenda Laurel's (1986) influential doctoral dissertation *Toward the design of a computer-based interactive fantasy system*, although only a few of the more recent studies have identified themselves as such. In a typical research through design project the researchers design and usually implement a game or games in order to pursue a further research aim, such as developing guiding principles and conceptual frameworks (Guardiola and Natkin, this volume; Back and Waern, this volume), validating a certain design approach in serious games studies (Quinten, et al., this volume), or understanding game design as an activity (Holopainen, et al., 2010). Coulton and Hook (this volume) provide a more thorough game design practice oriented discussion, while the rest of this section highlights some of the prominent examples of research through game design.

The 1990s and early 2000s saw a rise in both academic and industry based research teams engaging in research through game design. Many of these initiatives explored the potential of (then) upcoming technologies for game development. For example, Interactive Institute's PLAY Studio (1999–2004) in Gothenburg, Sweden, worked on location-aware (Falk, et al., 2001) and ubiquitous computing games (Björk, et al., 2002) while Mixed reality lab at University of Nottingham together the artist group

Blast Theory focused on exploring mixed reality with games such as *Desert rain* (1999) and *Can you see me now?* (2001) (see Benford et al., 2002). Finland around the same time was active in shaping the international game research community. Game research lab at University of Tampere used design-based approach in multiple projects and developed games such as *The footprints of power* in 2002 (cf. Ekman and Lankoski, 2004) to explore games and storytelling in interactive television and *The songs of north* in 2003–2004 (cf. Lankoski, et al., 2004) to understand the potential of location-aware mobile games. Nokia Research Center, also in Tampere, had several research through game design projects from 1999 onwards, often collaborating with academic research teams (e.g., Falk, et al., 2001; Suomela, et al., 2004; Holopainen, Nummenmaa and Kuittinen, 2010; Koivisto and Eladhari, 2006). Lankoski, et al. in Aalto University developed *Lies and Seductions* (Lankoski, et al., 2009) in order to explore character-driven game design methodology and further develop it. In addition the game aimed to study possibilities of social conflict -based gameplay (cf. Lankoski, 2010).

In 2004, the Integrated project on pervasive games (IPeRG), collected researchers from University of Nottingham's Mixed reality lab, University of Tampere's Game research lab, Interactive Institute's Play studio (later Game studio), and Nokia Research Center's Game design team. The backbone of the project was formed by the design and development of game showcases: for example, *Epidemic menace* (cf. Lindt, et al., 2007) and *Day of figurines* (cf. Flintham et al., 2007). The showcases were used to advance the understanding of pervasive game design and development and the results, including design guidelines and frameworks, are collected in Montola, et al. (2007).

Similar North-American approaches include, for example, Regan Mandryk's and Kori Inkpen's (2001) work on computer supported cooperative play and Carnegie Mellon's Oz-project on interactive drama (Bates, 1992). Michael Mateas translated his expertise on believable characters built in Oz-project to games with *Façade* (cf. Mateas and Stern, 2003). The trend has since grown stronger with several research teams and centers engaging in research through design.

Academic conferences, such as ISAGA, SIGGRAPH and SIGCHI, had already published research through game design studies for a long time but several new academic venues emerged in the early 2000s. The first international conference on entertainment computing (ICEC) was held in 2001 followed by the first Advances in computer entertainment technology (ACE) conference in 2004. In addition to ICEC and ACE, newer conferences such as CHI PLAY (from 2014) and Foundations of Digital Games (from 2009) contain a substantial amount of research through design studies, though the authors may not explicitly identify their work as such.

Designing games for a purpose of gaining new knowledge, in other words research through game design, has been an integral, although often implicit, part of game research. Discussing and criticizing research through design as an approach has made researchers more aware of their methodology in fields such as HCI (Zimmerman, Stolterman and Forlizzi, 2010; cf. Gaver, 2012). Coulton and Hook (in this volume) and Back and Waern (in this volume) discuss challenges in using research through game design later in this book.

DESIGN AND EVALUATION METHODS RESEARCH

Design methods have been an integral part of general design research (Vries, Cross and Grant, 1993). Game designers have been working on design and evaluation methods for a long time starting with autobiographical works that provide important insights for understanding game design practices within game industry. There are numerous textbooks on game design advocating different methods

and techniques and there is a growing body of systematic work on game design methodology (cf., Dormans and Holopainen, this volume). Moreover, understanding norms and assumptions behind different methods and approached is one emerging line of study (see, for example, Marcotte and Khaled, this volume).

Microsoft has been active in game design and evaluation methods from early 2000. For example, Pagulayan, et al., (2003) present user-centric design approach for games and Lazarre and Keeker (2004) described an approach for evaluating games.

Fullerton, Swain and Hoffman (2004) in their *Game design workshop* textbook, outline design methodology based on prototyping, iteration, and playtesting. Sweetser and Wyeth (2005) provide heuristic model based on Csikszentmihalyi's (1990) flow theory for evaluating game enjoyment. Dorman's (2012, 2017) *Machinations* design approach and tool allows simulation based fine-tuning of game systems. The design of serious games has been a hot topic and there are multiple design frameworks for them (e.g., Quinten, Malliet and Coninx, in this volume; Gunter, Kenny and Vick, 2006; Yusoff, et al., 2009; Annetta, 2010).

In addition for general game design approaches, there are also more specific methods for designing, for example, character-based games, pervasive games and education games. Lankoski (2010; cf. Lankoski, Heliö and Ekman, 2003) suggest a character-driven game design approach that draws from Egri's (1960) method for theatre script-writing³ and Isbister (2006) focuses on design of believable game characters based on psychological theories.

All heuristic evaluation methods and many design methods are normative: they are based on a specific norm of a good game or playing experience. These approaches promote norms such as immersion or believable game characters. Methods focusing on the design or development process do not necessarily take similar normative stances, as their focus is on the process, not in the artifacts produced. Notably, Jones (1981), writing on design methods in general, argues that changing a design method can give a new perspective to a design problem and thereby help solve it. Jones' argument applies to game design methods: they provide a perspective intended to help to solve a design problem.

Nacke and Lindley (2008) show an approach to compare player experiences using psychophysiology and psychometrics, Pedersen, et al. (2009) describe a study about modeling play experience in relation to design features and Mourato and Santos (2010) do statistical modelling on the difficulty of platform games using play data. Cowley, et al. (2014) present an empirical study where they look at play patterns based on play data and connect that data to design patterns analysis of the game, aiming to bridge the gap between analytical design studies and empirical player studies.

Evaluation methods also have application in the research for design area. Weber, et al. (2011) exemplifies a focused look at the relationship between retention of players and game design choices. El-Nasr, Drachen and Canossa's (2013) provide an extensive look at using game analytics to support game design.

3. Egri's approach has been utilized, at least, in more autobiographical works of Sheldon (2004) and Krawczyk and Novak (2006).

STUDIO AND DEVELOPERS AT WORK STUDIES

The main feature of the empirical phase is that the data of player behaviour or development practices is gathered using various methods such as interviews, observations and questionnaires; the data is not generated by researchers playing games by themselves or by designers reflecting their on own development experiences. An early example of an interview-based study of hobby game production is Laukkanen's (2005) study on game modding and modders.

From the late 2000s onward multiple researchers have been examining projects within commercial game companies. Hagen (Hagen, 2009; 2011) interviewed designers and analysed material from various early design phase in order to understand the ideation process at the early stage of game development. Based on a year of ethnographic work, Malaby (2009) presents a study about how *Linden Lab* approaches their development work on *Second Life* (2003–). Peltoniemi (2009) and Kultima (2010) look at the development cultures within game companies. O'Donnell (2014) has been conducting ethnographic studies about design practices in studios covering both the pre-production phase and the production phase and extending his analysis to how market forces shape design and development work. Koleva, et al. (2015) provides another study looking at actual development processes using ethnomethodology and a questionnaire.

Developers have been interviewed in multiple studies to develop understanding various aspects of development process. Kultima has studied innovation in companies (Kultima, 2010) and the role of iteration in game development (Kultima, 2015) by interviewing developers. Tschang (2007) has looked at how developers balance between creativity and different types of constraints (such as resources, increasing complexity, and coherence within a game) in game development. Sandovar (in this volume) and Marcotte and Khaled (in this volume) provide two additional perspectives to study indie developers' practices.

Game jams have been providing an alternative channel for looking at development processes. For example, Zook and Riedl (2013) studied conceptualisation and Kultima, Alha, and Nummenmaa (2016) analyzed the role of constraints in development processes in game jams.

WHERE ARE WE NOW; WHAT NEXT

Our historical look at game design research divides work into the headings of: conceptual approaches; research through design; design and evaluation methods; and studies of studios and developers at work. Many research cases focus on these aspects but extend into other directions as well. However, our review of game design research builds on our own histories as researchers. Systematic review of the area would be needed for building better understanding what is happening in the field. Nevertheless, we have shown that game design research consists of various different approaches with the common aim of gaining insight by looking at games as design processes or systems, including how the systems shape play and experience. This means that a large body of game research is not game design research: for example, MMO studies that look at play in MMOs, but do not consider how game systems modulate and regulate play. There the focus is understanding play as play without intention to gain knowledge on (game) design of MMOs.

Conceptual approaches have centered around the definition of a game (or gameplay) relate to philosophy of design (cf. Galle, 2002) and analytical philosophy. Tavinor (2009) illustrates in *The art of videogames* how game studies in general would benefit from better philosophical rigour when developing definitions (pp.15–33). His argument is relevant also to game design research. The areas

of philosophy of science in game design research and the ethics of game design are rarely studied. Kultima (in this volume) reflects on the ontology of game design research and Chiapello (in this volume) discusses the epistemology of game design research. Sicart (2009, pp.207–221) in his *The ethics of computer games* looks at the ethics of game design as a part of his project to understand ethics of games and play in a more general sense. We hope to see more research in the future into the area of philosophy of design.

Many modern 3D games model urban and rural spaces. Totten (in this volume) shows how a historical research approach (cf. Wang and Groat, 2013) drawn from architecture can be used in game design research. Architectural research and research in urban design has a long tradition (e.g., the *Journal of Urban Planning* has been running from 1996 and *Architectural Research Quarterly* from 1995) in topics relating to game spaces. While the research and research approaches in architecture and urban planning might not be directly applicable to research of game spaces and the use of game spaces, game design research still can learn from the approaches used in those areas.

As we have illustrated above game design research provides theories⁴ that are fundamentally normative; these theories make claims about the qualities of good games and how to design good games. However, scientific design theories are not purely normative, but rather build on descriptive theories of games, the relation between play and game, or play experience. (cf. Wang and Groat, 2013, pp.109–122; Niiniluoto, 1993; Chiapello, this volume.) The nature, role and construction of these game design theories remains largely unexplored (Dormans and Holopainen, this volume). Friedman (2003) and Redström (2017), for example, have argued that constructing or making design theories is essential for advancing the knowledge in the field, ultimately leading to better practices and products. We hope that this book contributes to the exploration and articulation of how and why to make game design theories.

Above we have outlined and categorized types of game design research. We presented autobiographical approaches, comparative and conceptual approaches, research through design, design and evaluation methods research, and studio and developers at work studies. Each of these have a different focus on what kind of knowledge the researchers are interested in. Moreover, different research types complement each other providing understanding relating game design, its products and processes. The following chapters continue in describing game design research in more detail from various point of views.

BIBLIOGRAPHY

All web references in this book are checked at September 2017.

Annetta, L.A., 2010. The 'I's' have it: A framework for serious educational game design. *Review of General Psychology*, 14(2), p.105.

Bateman, C. and Zagal, J., 2017. *Game design lineages*. Available at: <<https://prezi.com/l6hgs5qvpq2t/game-design-lineages/?webgl=0>>.

Bates, J., 1992. *The nature of characters in interactive worlds and the Oz project*. Carnegie Mellon University.

4. Following Mautner's (2005, p.426) simple definition of a theory: "a set of propositions which provides principles of analysis or explanation of a subject matter. Even a single proposition can be called a theory."

- Benford, S., Fraser, M., Reynard, G., Koleva, B. and Drozd, A., 2002. Staging and evaluating public performances as an approach to CVE research. ACM Press, pp.80–87. DOI=571878.571891.
- Björk, S. and Holopainen, J., 2005. *Patterns in game design*. Charles River Media.
- Björk, S., Holopainen, J., Ljungstrand, P. and Mandryk, R., 2002. Special Issue on Ubiquitous Games. *Personal and Ubiquitous Computing*, 6(5), pp.358–361.
- Björk, S., Lundgren, S. and Holopainen, J., 2003. Game Design Patterns. In: *Proceedings of the 2003 DiGRA international conference: Level up*. Available at: <<http://www.digra.org/wp-content/uploads/digital-library/05163.15303.pdf>>.
- Costikyan, G., 1994. I have no words & I must design. *Interactive Fantasy*, (2).
- Cowley, B., Kosunen, I., Lankoski, P., Kivikangas, J.M., Jarvela, S., Ekman, I., Kemppainen, J. and Ravaja, N., 2014. Experience Assessment and Design in the Analysis of Gameplay. *Simulation & Gaming*, 45(1), pp.41–69.
- Crawford, C., 1984. *The art of computer game design*. Osborne/McGraw-Hill.
- Cross, N., 1999. Design research: A disciplined conversation. *Design issues*, 15(2), pp.5–10.
- Csikszentmihalyi, M., 1990. *Flow: The psychology of optimal experience*. Nachdr. ed. Harper Perennial Modern Classics. Harper [and] Row.
- Dormans, J., 2012. *Engineering emergence: applied theory for game design*. PhD. University of Amsterdam.
- Dormans, J., 2017. *Machinations*. Available at: <<https://www.machinations.io/>>.
- Ekman, I. and Lankoski, P., 2004. Integrating a game with a story—lessons from interactive television concept design. *Computers & Graphics*, 28(2), pp.167–177.
- Elias, G.S., Garfield, R. and Gutschera, K.R., 2012. *Characteristics of games*. MIT Press.
- El-Nasr, M.S., Drachen, A. and Canossa, A. eds., 2013. *Game analytics: maximizing the value of player data*. Springer.
- Falk, J., Ljungstrand, P., Björk, S. and Hansson, R., 2001. Pirates: proximity-triggered interaction in a multi-player game. ACM Press, p.119. DOI=634067.634140.
- Faria, A.J., Hutchinson, D., Wellington, W.J. and Gold, S., 2009. Developments in business gaming: A review of the past 40 years. *Simulation & Gaming*, 40(4), pp.464–487.
- Flintham, M., Giannachi, G., Benford, S. and Adams, M., 2007. Day of the figurines: Supporting episodic storytelling on mobile phones. In: Cavazza, M. and Donikian, S., eds., *Virtual storytelling: Using virtual reality technologies for storytelling*. Springer, pp.167–175.
- Forlizzi, J., Zimmerman, J. and Stolterman, E., 2009. From design research to theory: Evidence of a maturing field. In: *International Assoc. of Societies of Design Research Conference*.
- Frayling, C., 1993. Research in art and design. RoyalCollege of Art research papers.

- Friedman, K., 2003. Theory construction in design research: criteria: approaches, and methods. *Design studies*, 24(6), pp.507–522.
- Fullerton, T., Swain, C. and Hoffman, S., 2004. *Game design workshop: Designing, prototyping, & playtesting games*. Focal Press.
- Galle, P., 2002. Philosophy of design: an editorial introduction. *Design Studies*, 23(3), pp.211–218.
- Gaver, W., 2012. What should we expect from research through design? ACM Press, p.937. DOI=2207676.2208538.
- Gunter, G., Kenny, R.F. and Vick, E.H., 2006. A case for a formal design paradigm for serious games. *The Journal of the International Digital Media and Arts Association*, 3(1), pp.93–105.
- Hagen, U., 2009. Where do game design ideas come from? Invention and recycling in games developed in Sweden. In: *Proceedings of the 2009 DiGRA international conference: Breaking new ground: Innovation in games, play, practice and theory*. Brunel University. Available at: <<http://www.digra.org/wp-content/uploads/digital-library/09287.25072.pdf>>.
- Hagen, U., 2011. Designing for player experience: How professional game developers communicate design visions. *Journal of Gaming & Virtual Worlds*, 3(3), pp.259–275.
- Holopainen, J., Nummenmaa, T. and Kuittinen, J., 2010. Modelling experimental game design. In: *Proceedings of DiGRA Nordic 2010: Experiencing games: Games, play, and players*.
- Hunicke, R., LeBlanc, M. and Zubek, R., 2004. MDA: A formal approach to game design and game research. In: *Proceedings of the AAAI workshop on challenges in game AI*, p.1722.
- Isbister, K., 2006. *Better game characters by design: a psychological approach*. The Morgan Kaufmann series in interactive 3D technology. Elsevier/Morgan Kaufmann.
- Jackson, S. and Schuessler, N., 1981. *Game design vol. 1: Theory and practice*. Steve Jackson Games.
- Järvinen, A., 2008. *Games without Frontiers: Theories and Methods for Game Studies and Design*. PhD. University of Tampere. Available at: <<http://urn.fi/urn:isbn:978-951-44-7252-7>>.
- Jones, J.C., 1981. *Design methods: seeds of human futures*. J. Wiley.
- Klabbers, J.H.G., 2008. *The magic circle: principles of gaming & simulation*. 2nd ed. Sense Publ.
- Knizia, R., 2010. *Dice games properly explained*. Blue Terrier Press.
- Koivisto, E.M.I. and Eladhari, M., 2006. Paper prototyping a pervasive game. In: *International conference on advances in computer entertainment technology 2006*.
- Koleva, B., Tolmie, P., Brundell, P., Benford, S. and Rennick Egglestone, S., 2015. From front-end to back-end and everything in-between: Work practice in game development. ACM Press, pp.141–150. DOI=2793107.2793131.
- Krawczyk, M. and Novak, J., 2006. *Game development essentials: game story & character development*. Thompson Delmar Learning.

- Kultima, A., 2010. The organic nature of game ideation: game ideas arise from solitude and mature by bouncing. ACM Press, p.33. DOI=1920778.1920784> .
- Kultima, A., 2015. Developers' perspectives on iteration in game development. ACM Press, pp.26–32. DOI=2818187.2818298>.
- Kultima, A., Alha, K. and Nummenmaa, T., 2016. Design constraints in game design case: Survival mode game jam 2016. ACM Press, pp.22–29. DOI=2897167.2897174.
- Lajos, E., 1960. *The art of dramatic writing*. Wildside Press LLC.
- Lakoff, G., 1987. *Women, fire, and dangerous things: what categories reveal about the mind*. 2012. The Univ. of Chicago Press.
- Lankoski, P., 2010. *Character-driven game design: A design approach and its foundations in character engagement*. School of Art and Design Publication series A 101. TAIK Books.
- Lankoski, P. and Björk, S., 2015a. Formal analysis of gameplay. In: P. Lankoski and S. Björk, eds., *Game research methods: an overview*. ETC Press.
- Lankoski, P. and Björk, S. eds., 2015b. *Game Research Methods: An Overview*. ETC Press.
- Lankoski, P. and Heliö, S., 2002. Approaches to computer game design. In: F. Mäyrä, ed., *CGDC conference proceedings*. TUP.
- Lankoski, P., Heliö, S. and Ekman, I., 2003. Characters in Computer Games: Toward Understanding Interpretation and Design. In: C. Marinka and R. Joost, eds., *Level Up Conference Proceedings*. Utrecht: University of Utrecht, Available at: <http://www.digra.org/dl/display_html?chid=05087.10012.pdf>.
- Lankoski, P., Helio, S., Nummela, J., Lahti, J., Mayra, F. and Ermi, L., 2004. *A case study in pervasive game design: the songs of north*. DOI=10.1145/1028014.1028083>.
- Lankoski, P., Horttana, T., Gustafsson, N., Karvinen, K., Pohjola, M., Neittaanmäki, R.-K., Kronman, L., Parkkali, A., Suominen, J. and Omaheimo, R., 2009. *Lies and Seductions*. Taik.
- Laurel, B., 1986. *Toward the design of a computer-based interactive fantasy system*. PhD. Ohio State University. Available at: <https://etd.ohiolink.edu/!etd.send_file?accession=osu1240408469&disposition=inline>.
- Lazzaro, N. and Keeker, K., 2004. What's my method?: a game show on games. ACM Press, pp.1093–1094. DOI= 985921.985922>.
- Lindt, I., Ohlenburg, J., Pankoke-Babatz, U. and Ghellal, S., 2007. A report on the crossmedia game epidemic menace. *Computers in Entertainment*, 5(1), p.8.
- Malaby, T.M., 2009. *Making virtual worlds: Linden Lab and Second life*. Cornell University Press.
- Malone, T.W., 1981. What makes computer games fun? *BYTE*, 6, pp.265–274.
- Malone, T.W., 1982. *Heuristics for designing enjoyable user interfaces: Lessons from computer games*. New York.

- Mandryk, R.L. and Inkpen, K.M., 2001. Supporting free play in ubiquitous computer games. In: *Workshop on designing ubiquitous computing games, UbiComp*. pp.1–6.
- Martin, F., Rob, A., Steven, B., Adam, D., James, M., Duncan, R., Amanda, O., Jon, S., Nick, T., Matt, A. and Ju, R.-F., 2003. Uncle Roy all around you: Mixing games and theatre on the city streets. In: *Proceedings of the 2003 DiGRA International Conference*. Available at: <<http://www.digra.org/wp-content/uploads/digital-library/05163.14092.pdf>>.
- Mateas, M. and Stern, A., 2003. Façade: An experiment in building a fully-realized interactive drama. In: *Game developers conference*. pp.4–8.
- Mautner, T., 2005. *The Penguin dictionary of philosophy*. 2. ed ed. Penguin reference. London: Penguin.
- Maxis Software Inc., 2000. *The Sims*. [game]. Electronics Arts.
- Montola, M., Jäppinen, A., Lahti, J., Lankoski, P. and Waern, A., 2007. *Designing pervasive games*. Integrated project on pervasive gaming IPerG deliverable.
- Mourato, F. and Santos, M.P. dos, 2010. Measuring difficulty in platform videogames. In: *Conferência Nacional Interação humano-computador*.
- Nacke, L. and Lindley, C.A., 2008. Flow and immersion in first-person shooters: measuring the player's gameplay experience. ACM Press, p.81. DOI= 1496984.1496998.
- Nagazawa, R.H., 1970. Research with simulation games: An analysis of success striving behavior. *Simulation & Gaming*, 1(4), pp.377–389.
- Niiniluoto, I., 1993. The aim and structure of applied research. *Erkenntnis*, 38(1), pp.1–21.
- O'Donnell, C., 2014. *Developer's dilemma: the secret world of videogame creators*. Inside technology. The MIT Press.
- Pagulayan, R.J., Keeker, K., Wixon, D., Romero, R.L. and Fuller, T., 2003. In: J.A. Jacko and A. Sears, eds. *The human-computer interaction handbook*. Erlbaum Associates Inc., pp.883–906.
- Parker, P.P., 2006. Learning when using commercial computer games as simulations: A case study using a simulation game. In: M. Pivec, ed., *Affective and emotional aspects of human-computer interaction: Game-based and innovative learning approaches: The future of learning*. IOI Press, pp.113–135.
- Pedersen, C., Togelius, J. and Yannakakis, G.N., 2009. Modeling player experience in Super Mario Bros. IEEE, pp.132–139. Available at: <<http://ieeexplore.ieee.org/lpdocs/epic03/wrapper.htm?arnumber=5286482>>.
- Peltoniemi, M., 2009. *Dynamics of the games industry*. PhD. Tampere University of Technology.
- CD Project RED, 2015. *Witcher 3: Wild hunt* [game], CD Project.
- Redström, J., 2017. *Making design theory*. Design thinking, design theory. The MIT Press.
- Rouse, R., 2001. *Game design: theory & practice*. Wordware Pub.

- Salen, K. and Zimmerman, E., 2003. *Rules of play: game design fundamentals*. MIT Press.
- Schell, J., 2008. *The art of game design: a book of lenses*. Elsevier/Morgan Kaufmann.
- Sheldon, L., 2004. *Character development and storytelling for games*. Thomson Course Technology.
- Sicart, M., 2009. *The ethics of computer games*. The MIT Press.
- Suomela, R., Rasanen, E., Koivisto, A. and Mattila, J., 2004. Open-source game development with the multi-user publishing environment (MUPE) application platform. In: *Entertainment computing – ICEC 2004*. Springer-Verlag Berlin, pp.308–320.
- Avedon, E.M. and Sutton-Smith, B., 1971. *The study of games*. 2015. Ishi Press.
- Sweetser, P. and Wyeth, P., 2005. GameFlow: a model for evaluating player enjoyment in games. *Computers in Entertainment*, 3(3), p.3.
- Tavinor, G., 2009. *The art of videogames*. Wiley-Blackwell.
- Totten, C.W., 2014. *An architectural approach to level design*. Boca Raton: CRC, Taylor & Francis Group.
- Tschang, F.T., 2007. Balancing the tensions between rationalization and creativity in the video games industry. *Organization Science*, 18(6), pp.989–1005.
- Vries, M.J., Cross, N. and Grant, D.P., 1993. *Design methodology and relationships with science*. Springer Netherlands. DOI=10.1007/978-94-015-8220-9.
- Wang, D. and Groat, L.N., 2013. *Architectural research methods*. 2nd ed. Wiley.
- Weber, B., John, M., Mateas, M. and Jhala, A., 2011. Modeling player retention in Madden NFL 11. Available at: <<https://www.aaai.org/ocs/index.php/IAAI/IAAI-11/paper/view/3526/4029>>.
- Yusoff, A., Crowder, R., Gilbert, L. and Wills, G., 2009. A conceptual framework for serious games. In: *Advanced Learning Technologies, 2009. ICALT 2009. Ninth IEEE International Conference on*. IEEE, pp.21–23.
- Zagal, J.P., Mateas, M., Fernández-Vara, C., Hochhalter, B. and Lichti, N., 2005. Towards an ontological language for game analysis. In: *Proceedings of DiGRA 2005 conference*. Vancouver, p.21.
- Zimmerman, J., Stolterman, E. and Forlizzi, J., 2010. An analysis and critique of *Research through Design: Towards a formalization of a research approach*. ACM Press, p.310. DOI=1858171.1858228>.
- Zook, A. and Riedl, M.O., 2013. Game conceptualization and development processes in the global game jam. In: *Workshop proceedings of the 8th international conference on the foundations of digital games*.

CHAPTER 1

EPISTEMOLOGICAL UNDERPINNINGS OF GAME DESIGN RESEARCH

LAURELINE CHIAPELLO

During the last decades, game design research has burgeoned, from Chris Crawford's seminal, *The art of game design* in 1984, to recent publications such as O'Donnell's (2014), *Developer's dilemma*. In 2010, Djaouti, Sandovarrez and Jessel (2010) counted more than 35 publications (e.g., textbooks, scientific papers, professional magazine articles, etc.) about game design methods. This augurs well for the development of better game designers (Schell, 2008) and, concomitantly, better games (Salmond, 2016). However, as with every corpus of knowledge, the sheer amount of information is overwhelming. Students of game design ask, *which book should I read?* Teachers wonder, *which method should I use to explain game design?* And researchers question, *which path should I take to keep enriching game design research?* This chapter attempts to deal with these questions by revealing the epistemological underpinnings of game design research. While it is more specifically oriented toward game design researchers, it can be useful for anyone wanting a new perspective on game design knowledge in order to critically assess a book, a method, or an approach.

DESIGN RESEARCH EPISTEMOLOGY AS A GUIDE

Critically examining human knowledge, its origins, and its limits, is commonly referred to as epistemology (Bunnin and Yu, 2004). This chapter thus aims to look at the epistemological underpinnings of game design research: how do game design authors (whether they be practitioners or academics) consider the knowledge they deliver through their writings? What are their assumptions concerning the *product* (the concepts, the theories) of their research, and the way it will be used? There are several different ways of answering this question. The way I choose is to enhance the *design* dimension of *game design*—that is to say, bridging together game design theories with design theories in general, and considering game design research as a part of design research.

At this point, I would like to stress that I consider myself primarily as a researcher in design. As a game designer, I participated in the creation of a few casual games, returned to university, and discovered design research in the Design School at the Université de Montréal's Faculty of Environmental Design. This trajectory has no doubt had an impact on my way of approaching game design theories and epistemology.

While design as an academic discipline is not even a century old, design theories are quite well developed. Amongst other subjects, these theories try to explain how designers think and work, and what constitutes *design* activities. Researchers have made important distinctions between design

research, interested in *designerly thinking* (as found in architecture, urban planning, interior design and industrial design departments), and *design thinking* (as found in management research, business schools and companies) (Johansson-Sköldberg, Woodilla and Çetinkaya, 2013). While interested in the same issues, the latter perspective “has a more superficial and popular character and is less academically anchored than the designerly one” (Johansson-Sköldberg, et al., 2013, p.121). Building on Johansson-Sköldberg, Woodilla and Çetinkaya’s (2013) conclusion, I suggest game design research should be allied to the *designerly thinking* research which is found in university design departments.

Furthermore, deciding where *game design theory* is situated is critical as it impacts on how it is taught. The diverse disciplines in university design departments, such as architecture, urban planning, industrial design, graphic design, and so forth, are often unified around a common pedagogy. This pedagogy values the *studio* or *workshop* experience as fundamental to developing relevant knowledge, understandings and practices. The teaching of game design, regularly characterized by the claim that to become a designer, one must design games, or *practice makes perfect*, seems to fit this pedagogical model.

Using extant design theories to understand and situate game design research—and more specifically its epistemological dimension—has the potential to provide new insights into game design activities. Design researchers often claim that design epistemology is understudied; however, a recent study by Burns, Ingram and Annable (2016) showed that between 1979 and 2015, design epistemology was the most popular topic of discussion in the journal *Design Studies* (see for example Cross, 1981, 2001; Broadbent, 2003; Bayazit, 2004; Bousbaci and Findeli, 2005; Bousbaci, 2008; Galle, 2011). Clearly design knowledge has been, and still is, under construction. The epistemological dimension is an angle to understand the evolution of game design theories; others could be used, but this one seems particularly pertinent as it can serve as a guide for future game design research.

While linking design theories and game design theories may seem natural, few attempts have been undertaken. It is true that many game design books attempt to define design and design research (see for example, Schell, 2008). Most of the time, when trying to embrace design studies, authors find themselves in the same position as many students, asking themselves, *which design theories are the most important?* and *which design theory should I use to study games?* Only a small body of research uses design theories as a support for elaborating game design theories. For example, Salen and Zimmerman’s (2003) book, *Rules of play* is quite noteworthy as it references seminal design works, like the ones of Schön (1983) and Simon (1969). Another significant work is the one of Björk and Holopainen (2004), inspired by Alexander’s thesis (1977) on design patterns in architecture. More recently, Kuittinen and Holopainen (2009) have advocated for game design to be studied through general design models, but unfortunately without any following publications (to the best of my knowledge). This chapter will elaborate on these examples, and others, to show how different epistemological assumptions present in design research are also present in game design research. It will explain why these assumptions have emerged, and why they have faded, as these clues might help us understand the strength and weakness of different game design approaches.

FOUR EPISTEMOLOGICAL PHASES

Using the different works that summarize the evolution of design theories evoked above, several design knowledge construction tendencies can be distinguished. This chapter is articulated around four epistemological phases that are presented chronologically: design as an applied art, design as an applied aesthetic, design as an applied science, and finally, design as a reflective practice. For each

of these periods, a summary will be made based on design research, followed by an analysis of game design research.

DESIGN AS AN APPLIED ART

Prior to design as a discipline, designers existed. Mostly, designers were seen as artists. Design disciplines referred to fine and decorative arts, and the designer was a *genius* who used a creative process based on intuition (Findeli and Bousbaci, 2005). The main problem of this portrayal of the designer is the mystery surrounding the actual practice. The knowledge and processes at work are not thoroughly explained, and various and contradictory definition of *art* are used (Findeli and Bousbaci, 2005). Chris Jones (1970) described this model of the designer as a *black box* and labeled it the *designer magician*. This poetic description is symptomatic of the vagueness emanating from the understanding of design as applied art.

As with designers in general, game designers existed before the recognition of game design as an academic pursuit, and the model of design associated with pioneer game designers retains some characteristics of applied art. Some game designers (e.g., Crawford) taught themselves. Others sometimes relate *war tales* in which they explain how they learnt game design before the advent of game design manuals. A frequent experience found in these stories is that of *compagnonnage* (i.e., apprenticeship, as in arts and crafts). An example of such *compagnonnage* can be found in Scott Rogers' 2010 book, *Level up!*, "When I wanted to become a video game designer, there weren't any books on the subject. We had to learn everything from other game designers. I was lucky to have a mentor and an opportunity to work as a game designer" (Rogers, 2010, p.xix). Rogers learnt the artistry of game design by imitating another skilled practitioner, in a way that remains unclear to outsiders.

With the proliferation of publications about game design, one can wonder if this artistic envisioning of game design persists. In effect, two books seem to particularly preserve this vision of design as an applied art: *The art of computer game design: Reflections of a master game designer* (Crawford, 1984) and *The art of game design: A book of lenses* (Schell, 2008). Jesse Schell (2008, p.xxix) states "game design is not an exact science. It is full of mysteries and contradictions". This perspective is reinforced throughout the book with regular use of the words *magic* and *magical* to describe specific moments in the design process¹. A significant passage that highlights the importance of the game designer's intuition can be found in chapter 7, where Schell suggests evaluating a game using seven filters. If the game passes these filter tests, it is supposed to be "good enough" (Schell, 2008, p.76). The initial filter directly summons the artistry of game design and the intuition designers require:

Filter # 1: Artistic Impulse: This is the most personal of the filters. You, as the designer, basically ask yourself whether the game 'feels right' to you, and if it does, it passes the test. If it doesn't, something needs to change. Your gut feelings are important. They won't always be right, but the other filters will balance that out." (Schell, 2008, p.77).

This is not the only filter recommended by Schell, but it is the first one presented. As Schell, Crawford recommends prioritizing the game designer's intuition: "Look within your heart, long and hard. If deep down inside you know that you met your goals, then ignore the critics and the public" (Crawford, 1984, p.55). *Heart, intuition, and gut feelings* highlight the element of artistry some see in game design.

1. These uses of "magic" must not be confused with the ones referring to conjuring or prestidigitation, an activity also discussed in the book, or with the experience that emerges from the game.

Even when authors do not explicitly develop the model of design as an applied art, some allude to the mysterious dimension of this practice, as do Bateman and Boon (2008, p.xi) in the book *21st century game design*, when they explain, “A certain mystery still surrounds game design”. The same kind of allusion can be found at the beginning of *Game design workshop* (Fullerton, 2008), where the reader discovers a collection of endorsements of the book. One, from Ian Bogost, combines the idea of art and magic: “Game design is something of a black art. The trick to doing it well is retaining the black magic but training oneself to control it. There are a lot of books on game design out there, but *Game design workshop* is amongst the very few that develops a wizard rather than a drone” (Fullerton, 2008, endorsements). However, the rest of the book does not subscribe to the model of design as an intuitive, magical process; indeed, most books that first evoke the artistry of game design then develop proposals aiming at demystifying and debunking the design process (see also Brathwaite and Schreiber, 2009).

Finally, game design as an applied art should not be mixed with games seen as a form of art. Most of the time, considering games as art is the basis of an argument that aims to demonstrate the cultural value of games (see for example Rouse III, 2010, p.532), which is not the subject here. Indeed, some definitions of the term *game* include the fact that it is an art without implying that the designer is an artist working with his intuition. This is the case in Greg Costikyan’s (1994) definition: “A game is a form of art in which participants, termed players, make decisions in order to manage resources through game tokens in the pursuit of a goal”. Concerning Costikyan’s definition, Salen and Zimmerman (2003, p.231) noted, “Labeling games as art embroils them in contemporary debates about games and art, high culture and low culture, and the social status of games. Undoubtedly, this is Costikyan’s provocative intention”. Thus, relating games to art does not necessarily mean that the process of game design stems from artistry. The emphasis is on the product, the game, not on the process of game design.

To summarize, the major epistemological problem of seeing game design as an applied art is the fact that it hides the activity of designers behind some form of *artistry*. Thus, even books that present design as an art do not fully adhere to this model. As it was the case with design theory in general, game design theories soon tried to “scientize” their subject in order to make it clear and intelligible.

DESIGN AS AN APPLIED AESTHETIC

The first attempts to make design more scientific and go beyond the purely intuitive representation of designing are often associated with the Bauhaus School (Bayazit, 2004). This school, led by Walter Gropius and originally located in Weimar, Germany, united the School of Applied Arts, founded by Henry Van de Velde in the early 1900s, with the School of Fine Arts. As described by Alain Findeli, Gropius dissolved the School of Fine Arts in the School of Applied Arts in order to “remove any reference to an artistic practice non-engaged in a trade, and any temptation for students-artists to take refuge in an ivory tower” (Findeli, 2005, p.141, our translation). With this merger, the way of seeing the designer changes: he is not considered as a privileged genius anymore, but as a craftsman who has a job. Thus, the Bauhaus created the conditions for a new representation of *design as an applied aesthetic*. In the knowledge model of applied aesthetics, *aesthetic* means a science of art: “a scientific conception of art sufficiently developed to constitute the theoretical framework from which the formal properties of the object will be rationally deduced” (Findeli and Bousbaci, 2005, p.8, our translation).

In game design research, a similar view was expressed in the book *Rules of play* (Salen and Zimmerman, 2003). In the foreword of the book, Frank Lantz recognizes game design as a *field* in the academic sense, and states that *Rules of play* can be seen as a manifesto for the creation of this field. Hence, he judges that the time has come for a “generically theoretical system” to unleash the potential of videogames. He thus suggests that the book be an “aesthetic approach of interactive systems”:

One of the implications of *Rules of play*'s approach to its subject is that the proper way to understand games is from an aesthetic perspective, in the same way that we address fields such as architecture, literature, or film. This should not be confused with the domain of visual aesthetics, which is simply one facet of a game's creative content. Like film, which uses dramatic storytelling, visual composition, sound design, and the complex dynamic organizational process of editing in the construction of a single work, the field of game design has its own unique aesthetic (Salen and Zimmerman, 2003, p.x).

In this way, according to Lantz, *Rules of play* is one of the first attempts at making game design more scientific.

However, as we will see, the idea of *applied aesthetic* is different from the one of *applied science*, which is more radical. An effective way of understanding the idea of an applied aesthetic is to go back to the pedagogical program of the Bauhaus School which united art, aesthetics and natural sciences (Findeli, 2005). This understanding of applied aesthetic might actually be best represented in Crawford's (1984) book. As stated earlier, Crawford sees games as art, and it is one of his very first claims: “The central premise of this book is that computer games constitute a new and as yet poorly developed art form that holds great promise for both designers and players” (Crawford, 1984, p.1). However, he carefully tries to avoid the trap of the vagueness of art, and almost immediately defines it: “art is something designed to evoke emotion through fantasy” (Crawford, 1984, p.2). While this approach is questionable, what is important to stress is that Crawford, while partly relying on the vision of game design as an intuitive process led by the heart, tries as much as possible to avoid mysterious and intuitive dimensions. Therefore, the model of design as an applied aesthetic seems to appropriately fit his work.

Further in his introduction, Crawford also makes a reference to aesthetics: “Real art through computer games is achievable, but it will never be achieved so long as we have no path to understanding. We need to establish our principles of aesthetics, a framework for criticism, and a model for development” (Crawford, 1984, p.4). These aspirations are very close to the ones of the Bauhaus School.

Moreover, the Bauhaus School pedagogical program contained a major component of *techniques*, or craft elements. This kind of knowledge is also present in Crawford's book. Indeed, the chapter 6, “Design techniques and Ideals”, opens by stating that designers need some specialized skills (Crawford, 1984, p.56). Per Crawford, an example of a game designer skill would be computer programming, but one can also think of fluent oral communication and writing abilities. Hence, Crawford's book is a good representation of the model of applied aesthetics, where the designer is still seen as an artist, but a more down to earth one, where mystical qualities are replaced by specific skills.

The model of design as applied aesthetics is a first attempt to make design more scientific (Findeli and Bousbaci, 2005; Bayazit, 2004). It contains the seeds of the epistemological model that will eventually prevail, the one of design as an applied science.

DESIGN AS AN APPLIED SCIENCE

The representation of design as an applied science had been growing since the end of the fifties, and remained dominant until the Design Methods in Architecture Symposium in 1967; this period is nowadays identified as the “first generation of design methods” (Bousbaci, 2008). Nigel Cross (1981), in his article *The coming of post-industrial design*, traces the evolution of design methods using the concept of *generations*, borrowing the idea from Hans Rittel (1973). During this first generation, researchers completely rejected the idea of the *designer-artist*, and replaced it with the *rational designer*. They turned to logic, systematic and objective descriptions of the act of designing. They moved away from the romantic and artistic design vision, which they replaced with *the problem-solving* perspective and took their inspiration from operational research (Bousbaci, 2008).

A similar trend can be observed in game design research where *scientization* is regularly formulated as a goal. For example, Tracy’s Fullerton (2008) book *Game design workshop’s* introduction stresses that she is looking for a “systematic solution”, a *method* for creating games. It is also worth noticing that this desire extends to the industry, with the example of Ubisoft, where game designers coined the term “rational game design” (McEntee, 2012; see also chapter 8 in this volume). An ex-Ubisoft game designer, Luke McMillan (2003), tried to elaborate a *Rational design handbook* which he finally turned into a series of *Gamasutra* posts. He starts by rejecting the artistic vision: “What used to bother me was the mysticism that seemed to surround effective design practices.” He thus defines rational game design as “way of objectively quantifying elements of user experience in order to create a consistent game play experience” (McMillan, 2013, p.1).

In design theories, Schön considered two aspects when speaking of turning design into an applied science. First, an applied science implies a preexisting fundamental science that will be applied; indeed, several authors suggested different sciences as fundamental for design. Second, the scientific approach is associated with the positivist model and its analytical dimension, which drove researchers to look for the “elementary particles” of their object, in the fashion of natural sciences (Schön, 1983). Both dimensions are present in game design research, and will be detailed now.

The importance of having a fundamental body of knowledge to apply in practice is not a problem unique to game designers. Many professionals are (or were) looking for a scientific model of their practice; indeed, the desire on the part of professionals to scientifically explain their activities is far from new. In his book *The reflective practitioner*, Schön (1983) explains the origins of this will to *scientize* professional activity. He describes the dominant model of the epistemology of practice in the seventies, which is the model of applied science, or *technical rationality*: “According to the model of Technical Rationality [...] professional activity consists in instrumental problem solving made rigorous by the application of scientific theory and technique” (Schön, 1983, p.21). In this model, a profession solves problems using scientific theories. The best examples of *professions* back then were medicine and law. Their goals were clear (health, dispute resolution), they were based on rigorous fundamental knowledge, and had a strong technological component. In contrast, less prestigious professions included social work, education or urban planning, whose goals were supposedly vague and whose professions did not rely on a clear fundamental body of knowledge to be applied. Within the technical rationality model, universities are the ones who conduct research and produce scientific knowledge, while professionals only apply and verify the knowledge produced by researchers. The skills required by a professional to implement this knowledge are not actually considered (Schön, 1983).

Following this implicit academic model, several authors in game design research looked for a fundamental science to build their theories on. They usually rely on a mix of mathematics (game theory), psychology, sociology, anthropology, cognitive science, and so forth. Some works clearly state their orientation; for example, *A Theory of fun* (Koster, 2010) relies heavily on mathematics, Isbister's (2006) and Bateman and Boon's (2005) work on psychology, and Schell's (2008) book on psychology and anthropology. Some, like Järvinen (2008), hope to create an "applied ludology", using psychology and sociology to construct a toolbox for game analysis. In the same vein, the work of Salen and Zimmerman (2003) aims to draw from the largest possible number of sciences to encompass what is game design: from semiotics to mathematics, *Rules of play* can be seen as a collection of examples of various applied sciences. So while the book's foreword is in favor of an *applied aesthetic* approach, the content of the book seems to be much closer to the *applied science* model.

In each case, the sciences invoked are supposed to give strong scientific foundations to the study of game design. As mentioned earlier, it is important to note that design theories are seldom used to create foundational knowledge in game design. The field's infancy might be a factor, as some authors just do not seem to know that design exists as an academic discipline (see for example Schell, 2008, p.14).

Additionally, what is important in a rational vision of design is the analytic approach. Schön (1983) stresses that the epistemological vision underlying the applied science model is that of positivism. According to Schön, positivists seek the irreducible elements that make up each phenomenon, in order to formalize it into a knowledge that then has to be applied. And once again, this positivist approach exists in game design research. Several researchers looking at game design have tried to find the elementary particles, fundamental components and perfect layout of games. This approach is often inspired by modern physics and chemistry, for which the atom was a revolution. While not necessarily adopting a fully rationalist model, Jesse Schell explains this quest for fundamental elements in a straightforward way, using the analogy of Mendeleev's periodic table:

We are in a position something like the ancient alchemists. In the time before Mendeleev discovered the periodic table, showing how all the fundamental elements were interrelated, alchemists relied on a patchwork quilt of rules of thumb about how different chemicals could combine. These were necessarily incomplete, sometimes incorrect, and often semi-mystical, but by using these rules, the alchemists were able to accomplish surprising things, and their pursuit of the truth eventually led to modern chemistry. Game designers await their Mendeleev. At this point we have no periodic table (Schell, 2008, p.xxv).

It is interesting to note that even if the book is from 2008, the author chose to rely on Mendeleev vision of chemistry, where atoms were considered fundamental particles. Around the same time as Schell, Cook (2007) used a similar metaphor in his *Gamasutra* paper *The chemistry of game design*:

The bigger (sic) hope is to move our alchemical craft toward the founding of a science of game design. We currently build games through habit, guesswork and slavish devotion to preexisting form. Building a testable model of game mechanics opens up new opportunities for game balancing, original game design and the broader application of game design to other fields. The advent of basic chemistry gave us tools to build a new world of technologies far beyond that imagined by our alchemist forefathers. Plastics, engines, fabrics, power sources revolutionized our lives. It is a worthy effort to crack the fundamental scientific principles behind the creation of games (Cook, 2007, p.1).

The global idea behind Cook's work is thus to find "scientific principles", where scientific appears to be synonymous with physics and chemistry.

This rationalist view seems to be shared in the game design research community, as several works, published before Cook and Schell's one, have approached game design theory in this way. A first group of research tried to dissect games in fundamental elements. Ben Cousins (2004) invented the "ludemes", which were then used by Raph Koster (2010) in his *Theory of fun*. Salen and Zimmerman (2003) created the "choice molecules", Rollings and Morris (2004) the "tokens", and Aki Järvinen (2008) the "game elements". Rolling and Morris' analysis of Pong provides a good example of what these fundamental elements of a game can be: "The player avatar for Pong is very simple; it is merely a bat and a score. These are how the player is represented in Pong. The other tokens—those manipulated by the computer—are the ball, the walls, and the goal zones" (Rollings and Morris, 2004, p.482). The authors then explain how the parts are combined to form the game using a matrix and proceed to analyze the game.

Another group of studies still relies on units, but is not exclusively focused on game parts: the units can be more complex, and more "systemically" organized, which means interaction between the elements are given more importance. A well-known model is the MDA (Mechanic Dynamic Aesthetic) model (Hunicke, LeBlanc and Zubek, 2004). Cooks also proposed the "skill atoms" which are units describing "how the player gains a new skill" (Cook, 2007, p. 3). Other examples include Bura's "Game Grammar" inspired from Petri Nets and cybernetics (Bura, 2006), and featuring "grammar elements", Lecky-Thompson (2008) "objects", derived from object oriented programming, and Dormans' (2011) *machinations* inspired from system theory. However, as noted by Djaouti (2013), none of these models seem to be wildly used in the industry.

PATTERN LANGUAGE

One body of work in game design research actually relies on design as a fundamental science and uses it to find fundamental patterns. It found its origins in Christopher Alexander's (1964) seminal works, *Notes on the synthesis of form* and *A pattern language* (Alexander, Ishikawa and Silverstein, 1977). Alexander's *Notes on the synthesis of form* is considered as an emblematic thesis of the *design methods movement*. As a proponent of rationality, Alexander (1964, p.8) suggested replacing intuition by logic and outlined a "hierarchical program" in order to reach this rationality. His solution takes the form of patterns, that is to say the basic components of design:

Scientists try to identify the components of existing structure. Designers try to shape the components of new structures. The search for the right components, and the right way to build the form up from these components, is the greatest physical challenge faced by the designer. I believe that if the hierarchical program is intelligently used, it offers the key to this very basic problem—and will actually point to the major physical components of which the form should consist (Alexander, 1964, p.130).

Alexander then developed these patterns and Bayazit summarizes their functioning:

Alexander tried to split the design problems into solvable small patterns by applying information theory. He sorted out those that interacted with each other, and solved the problems of each group by drawing a diagram in which the interactions—either fit or misfit—of user requirements were resolved between the components within and amongst patterns (Bayazit, 2004, p. 18).

Patterns were then adopted in computer science (Gamma, et al., 1994), education (Sharp, Manns and Eckstein, 2003), and human computer interaction (Borchers, 2001), to name a few. In game design, patterns have been used by different authors (Simpson, 1998–1999; Church, 1999; Kreimeier, 2002), until they really acquired recognition with the work of Staffan Björk and Jussi Holopainen (2004),

Patterns in game design. However, Björk and Holopainen's use of patterns has been criticized: their patterns were slightly different from Alexander's and are more descriptive than prescriptive (McGee, 2007). But Björk himself addressed these critics and defended a point of view similar to Alexander's; according to Björk, patterns can not only be used for analyzing and for designing games, but also for communicating within a team (Olsson, Björk and Dahlskog, 2014). Recently in game design, patterns have been used to make and analyze many different games: mobile games (Rasool, Khan and Hussain, 2015), serious games (Huynh-Kim-Bang, Wisdom and Labat, 2010), and location-based games (Will, 2013).

THE END OF DESIGN AS AN APPLIED SCIENCE

From the late sixties though, the model of applied science began to demonstrate its limits for design research. During the Design Methods in Architecture Symposium in Portsmouth in 1967, a schism was created between researchers wishing to retain this mechanistic and quantifiable vision of the design process, and those who wished to consider the more human dimensions of designing (Bayazit, 2004). The second emphasized that the vision of design as an applied science did not have the success that it had promised to. Alas, design problems did not appear to be solved with methods originating from the sciences (Cross, 1981), methods that proved too inflexible and simplistic (Bayazit 2004). In the seventies, several major authors from the Design Methods Movements rejected the value of rationalism and logic, including Alexander, who declared: "I've disassociated myself from the field... There is so little in what is called *design methods* that has anything useful to say about how to design buildings that I never even read the literature anymore... I would say forget it, forget the whole thing" (Alexander, 1971, cited in Cross, 2001). While Alexander continued his work on design patterns, his approach changed drastically and took what can be seen as a phenomenological direction (Seamon, 2007).

Design research then tried to modify the over-rationalistic method of the first generation. In the seventies, another mutation of how designers are represented happened, which Bousbaci (2008) identified as "a designer with bounded rationality", in reference to Herbert Simon's work. Although Simon (1969) is not a design researcher, his book, *The sciences of the artificial* constitutes a defining moment in the representation of design activities. While remaining in the model of applied science, Simon offers theoretical developments concerning rationality and human decision-making that were seen as relevant to understanding the design project. In particular, Simon was not satisfied with the two dominant views of human rationality. On the one side of the spectrum is rationalism, which, as explained above, involves seeing the human being as an entirely logical being. On the other side is behaviourism, which implies a form of environmental determinism: human decisions are therefore responses to external stimuli. In response, Simon proposed an intermediate position, that of bounded rationality, which helps to better understand human action in uncertain situations, such as design projects (Bousbaci, 2008). In order to deal with uncertain situations, and to help solving problems where the desired result is not fixed, Simon developed the concept of "ill-structured problems" (Simon, 1969). These are problems that are ill-defined and difficult to represent, and that can withstand scientific methods. Design problems are an example of such a class of problems, and Simon suggests different ways of transforming them into well-formulated instrumental problems, in order to solve these problems. He thus presents design as a problem solving activity.

Simon's ideas coincide with the second and third generation of design methods. Cross (1981) explains that the second generation of design methods, as introduced by Rittel (1973), helps revitalize the movement of design methods, which tended to falter facing the discovery that design problems could

not be solved with scientific methods. Rittel and Webber (1984) developed the concept of *wicked problems*: while this idea is comparable to Simon's ill-structured problems, Rittel and Webber put more emphasis on the fact that design problems are never completely solved, as they are complex and lack the clear boundaries needed to give them a neat solution.

The design methods of this second generation turned toward participatory design (since the designer is not the only one to hold relevant knowledge) and toward the importance of a design project's argument (the designers justify their perspectives with their own values and not only with logical reasoning) (Cross, 1981). The third generation of design methods focused on the subjectivity of designers and their preconceptions. But according to Cross (1981), these generations did not witness the success expected by Rittel. One reason for this is the lack of interest in participatory design in engineering and industrial design (Cross, 1981).

These amendments to the full rationality of the first generation fit with certain game design research works. For example, Schell, who yearned for the Mendeleev of game design (as explained earlier), estimates that such a rational vision of game design might never come:

I wish we had one all-seeing lens. We don't. So, instead of discarding the many imperfect ones we do have, it is wisest to collect and use as wide a variety of them as possible, for as we will see, game design is more art than science, more like cooking than chemistry, and we must admit the possibility that our Mendeleev will never come (Schell, 2008, p.xxvi).

In the same fashion, as explained earlier, Björk and Holopainen's (2004) work relies on Alexander's rational patterns; however, these authors moderated the rationalist foundations of their own model. They wrote, "A more appropriate comparison of the use of patterns is to the artistic endeavor in general: the artist has much better chances to create something novel when familiar, though not necessarily consciously, of the basic elements of her craft, be it painting, composing or scriptwriting" (Björk, Lundgren and Holopainen, 2003, p.190). They thus considered that there was still a part for a designer's creativity and subjectivity. Not unlike Simon and Rittel and Webber, Björk and Holopainen also saw design problems as wicked problems (Olsson, Björk and Dahlskog, 2014), thus being more related to the second and third generation of design methods than the first.

In conclusion, as Jesse Schell (2008) suggests, the Mendeleev of game design might never come, and rationality will likely never prevail. On the other hand, the absence of a Mendeleev of game design might not be the end of the world, as other representations of the designer and design activities are possible.

DESIGN AS A REFLECTIVE PRACTICE

SCHÖN'S DILEMMA OF RIGOR AND RELEVANCE

A turning point in design research happened in 1983 with the arrival of the book by Donald Schön (1983), *The reflective practitioner: How professionals think in action*. In this book, Schön explores professional knowledge and seeks to understand the relationships between different types of knowledge and their differentiating elements. He is particularly interested in the marked divide that has been observed between academia and professional practice. He thinks that this dichotomy comes from the inability of professionals to explain their form of knowledge. He therefore proposes developing an epistemology of professional practice.

For Schön, the main difference between the positivist view of professional knowledge and reality lies in how problems are understood. In the applied sciences, professional practice exists to solve problems. But the situations professionals face are “unstable”, “embarrassing” (Schön, 1983), and sometimes ill-defined. According to Schön, the question, “how should I act?” is embarrassing for positivists who prefer to consider the most appropriate instruments for achieving a goal. Thus, building a road is an easily solvable problem, provided you ignore the fact that it destroys the landscape and can have negative consequences for nearby residents. This instability and uncertainty are disruptive to the positivist epistemology of professional knowledge, for they seem to go against the positivist rigor. Yet ignoring them removes any relevance to this thinking: this is described by Schön as the “dilemma of rigor and relevance” (Schön, 1983, p.42). Schön thus put emphasis on design as a problem setting activity, more than a problem solving one (Schön, 1983, p.40).

In game design, a very similar situation is described by Bateman and Boon (2005) in the preface of their book, *21st century game design*, where they introduce *zen game design*. The preface starts with an anecdote from designer Paul Jacques, who, when asked what game design is, could not answer. Similarly to the professionals studied by Schön (1983), this designer, while competent, falls short when having to explain what he does and what he knows. As a result, Bateman and Boon explain their own philosophy of game design and state that “certainly, *ihobo* is one of the few game design companies in existence with a philosophy of game design that is founded largely on subjectivity, rather than objectivity, which is curious and unusual” (Bateman and Boon, 2005, p.xi). Here, the authors reject the rationalist and objective vision of the applied science model. However, finding another model is not an easy task. Bateman and Boon turn to Japanese game design, but explain that they cannot truly use it as a foundation for their book:

However, it is likely we will never see a definitive book on game design from a Japanese author, because when Japanese game designers do publicly discuss their methods, they display a kind of holistic thinking that defies decomposition into method, and what the Western audience seems to crave is precisely that—a mechanistic approach that can be acquired or emulated” (Bateman and Boon, 2005, p.xii).

What they describe can be seen as a dilemma of rigor and relevance. To them, as practitioners, the Japanese approach to game design is relevant. However this relevance simultaneously lacks what the positive epistemology defines as rigor: a method that decomposes game design in analyzable units, according to a mechanistic view.

KNOWING-IN-ACTION

Going back to design in general, Schön suggested a way to get out of the dilemma described above. According to him, if the current model (the positivist epistemology of practice) does not capture professional activity adequately, a new model is needed. By defining the crisis in terms of knowledge, Schön makes his way toward this new model: it is necessary to set up a new epistemology of practice that rejects the model of Technical Rationality. Inspired by pragmatism, Schön shows that the rejection of the model of applied science allows one to consider another source of knowledge: action. Professional knowledge is tacit and lives in practitioners’ actions; practitioners act appropriately in a given situation, without thinking about it: “By knowing-in-action I mean the knowing built into and revealed by our performance of everyday routines of action” (Schön, 1992, p.124).

In game design, Bateman and Boons (2005) came very close to the same conclusions as Schön. In a parallel example unrelated but applicable to game design, they explain:

Zen Buddhism is a branch of the Eastern religion in which the underlying message is implied rather than stated. Indeed, one of the key concepts in Zen Buddhism is that enlightenment cannot be expressed in words, because you must make a leap beyond the literal—it must be experienced, not learnt. It also includes the idea that there is no objectively correct and definitive perspective on anything—all experience is relative. (Bateman and Boon, 2005, p.4)

If enlightenment is considered as a form of knowledge, and experience as a synonym of action, then the way Batemans and Boons present Zen Buddhism is quite close to Schön's epistemology of professional practice: a form of knowledge lies in the game designer's experience. Unfortunately, Bateman and Boons do not explicitly draw on these principles and prefer to establish a psychological portrait of players than to explore the professional knowledge of game designers.

To summarize, Schön's (1983) new model questioned the rationalist representations, and proposed that professional knowledge is no longer an applied knowledge (applied art, aesthetic applied or applied science), but a type of knowledge in itself, emanating from the practitioners. Schön opposed two different models of the epistemology of professional practice: first, the positivist one where knowledge is seen as produced by academics and applied by professionals, and, second, the reflective one, where knowledge is produced by the practitioners themselves, in practice.

In game design research, some books demonstrate a similar interest of knowledge coming from practice, even if they do not clearly develop their epistemological position on it (and sometimes even state contradictory intentions in their preface). For example, Tracy Fullerton's (2008) book *Game design workshop*, or Brathwaite and Schreiber's (2009) *Challenges for game designers*, put a large emphasis on making games, as their books are full of practical exercises. Another expression of this confidence in practitioners' knowledge can be found in the preface of Scott Rogers' (2010) book *Level up!* where he rejects preceding hard theories of game design:

There are lots of books about video games design, but most of them are full of THEORY, which I have never found very helpful while making a game. Don't get me wrong, theory is great when you are at a game developers' conference or one of those wine and cheese affairs we game designers always find ourselves at. But when I am working on a game, with my sleeves rolled up and blood splattered all over the walls, I need practical nuts n' bolts advice on how to solve any problems I may encounter (Rogers, 2010, p.xix).

With this sentence, Rogers acknowledges the vast effort that took place for theorizing game design, but he throws it to the wind, choosing the benefits of "experience" over "theory". It is difficult to fully understand what Rogers means by "theory"; nevertheless, the importance of knowledge coming from practice for game designers is established.

REVEALING PRACTITIONERS' KNOWLEDGE

This acknowledgment of professional knowledge is not a return to the model of the designer-genius. Once identified, professional knowledge can be improved, unlike artistic intuition, which is nebulous. However, it is also true that the professionals' practical knowledge is often implicit and thus difficult to describe (Schön, 1983). But according to Schön (1983), this difficulty does not mean that professional knowledge is mysterious and inaccessible. An effective way to show this tacit knowledge actually exists in practice is when it stops working. Faced with an unexpected event, a surprise, practitioners will question the nature of their actions. They realize they usually frame the situation in a certain way, that they habitually use certain criteria to assess a difficulty or that they normally enact some skill to fix a problem (Schön, 1983, p.50). All these habitual actions are the manifestation of this

knowledge. When practitioners become aware of this tacit professional knowledge through failure to achieve the desired outcomes, they also become aware of its limitations. Professional knowledge is therefore distinguishable, it is not a vague intuition.

Schön thus departs from the positivist epistemology of practice: “Once we put aside the model of Technical Rationality, which leads us to think of intelligent practice as an application of knowledge to instrumental decisions, there is nothing strange about the idea that a kind of knowing is inherent in intelligent action” (Schön, 1983, p. 50). According to Schön, if he were to stay in the model of applied science, when confronted with an unusual situation, the professional would be stuck: a doctor would not be able to cure a patient with a set of symptoms that is not described in his books, as he would not possess the knowledge to be applied. But as Schön recalls, professionals are regularly confronted with unusual problems, and they are able to solve them.

Schön describes this capacity to create new knowledge to deal with a situation as the process of *reflection-in-action*: “As [the practitioner] tries to make sense of it, he also reflects on the understandings which have been implicit in his action, understandings which he surfaces, criticizes, restructures, and embodies in further action” (Schön, 1983, p.50). Encountering unexpected situation where one’s knowledge is challenged is an opportunity to expand this knowledge. The practitioner does not need to stop and think: he reflects in the action, he sees the limits of his knowledge and overcome them, in a constant transaction with the situation. These explanations thus help one understand the well-known (Heiskanen and Newman, 1997, p.68) phrase of Schön’s: “When someone reflects-in-action, he becomes a researcher in the practice context. He is not dependent on the categories of established theory and technique, but constructs a new theory of the unique case” (Schön, 1983, p.68). This means that practitioners do not blindly apply the theories elaborated for them by researchers. They are not mere problem-solvers, but researchers that produce new knowledge to solve their problems.

In 2011, I conducted some research with casual game designers. I embraced Schön’s epistemology of practice to design my research project and was able to elaborate a definition of casual games based on casual game designers’ professional knowledge (Chiapello, 2012; 2013). Instead of asking game designers about their thoughts on certain aspects of casual games, like Jesper Juul (2009) did in his book *A casual revolution*, I revealed the game designers’ tacit knowledge by asking them to discuss their experiences making casual games, especially the times when they felt stuck and had to overcome obstacles. The outcomes were unexpected. The designers rejected many parts of the previous definitions of casual games like those proposed by Juul (2009) or Kultima (2009). A short example can help us understand how this approach was fruitful. When conducting my literature review on casual games, a recurrent element that surfaced was the importance of the game world, the theme, and the setting. According to academic publications, themes or settings in casual games should be cheerful and positive, while sexuality and violence should be avoided. But the game designers I interrogated had a very different vision. True, they were puzzled with respect to the question of which theme and setting to choose. But through an exploration and questioning of their audience, or even their own taste in stories, they crafted various narrative contexts, from dark science fiction to Mexican wrestling. A very different portrait of casual games thus emerged. While this new portrait is now widely accepted with the growth of mobile, social and casual games (Willson and Leaver, 2016), it was interesting at the time to see the gap between academic texts and the industry’s stance. This shows how a different epistemological approach can lead to different understandings of a phenomenon. For another example of a study embracing Schön’s epistemology of practice and using practitioners’ knowledge, refer to Jess Marcotte and Rilla Khaled (in this volume).

In conclusion, professional knowledge could be a key for understanding game design better. This does not mean that all advice from a practitioner is valid knowledge, however. It only means that skilled practitioners hold a form of tacit knowledge that does not fit into the applied science framework, where practitioners are supposed to systematically apply theoretical solutions coming from academics to solve their problems. Therefore, academics should adapt and stay open to this kind of epistemological perspective.

EPISTEMOLOGY IS A MESS

This chapter discussed the epistemological underpinnings of game design research and their evolution over time. Four theoretical perspectives serve as guides to clarify this evolution: design as an applied art, design as an applied aesthetic, design as an applied science, and design as a reflective practice. These classifications of design's epistemological foundations were inspired by the works of several very notable authors in design research, but they are not necessarily representative of design thinking in its entirety (Johansson-Sköldberg, Woodilla and Çetinkaya, 2013). Nevertheless, they provide unique understandings of design research in general that are relevant and appropriate for game design research albeit with some important differences in their applicability.

Firstly, in design research in general, different epistemological perspectives appear chronologically. Contrariwise, in game design research, the different epistemological foundations coexist simultaneously with no clear progression over time.

Secondly, epistemological positioning of game design research is often implicit. This sometimes makes it difficult for the reader to fully appreciate the purpose of a text. For example, some books feature interviews with game designers (e.g., Saltzman, 1999; Fullerton, 2008). Should these interviews be seen as a glorification of genius game designers, in an applied arts fashion? Or are they the embryo of a reflective approach, where game designer discourses are seen as a way of revealing their tacit knowledge?

Thirdly, several books feature mixed epistemological trends. Crawford's (1984) *The art of computer game design* combines the epistemological positions of design as an *applied art* and design as an *applied aesthetic*. Tracy Fullerton's (2008) book insists on a rationalist approach in its introduction, but the global approach as a workshop values *reflective knowledge* originating from practice more than from an *applied science*. In this same book, game designers are also presented as "wizards rather than drones", thus distancing from a rational approach (drone) and preferring the artistic approach (wizard). Similarly, in *Challenges for game designers*, Brathwaite and Schreiber (2009) present game design as an *art*, but also rely on practical exercises that are closer to the model of *knowing-in-action*. Following these mixes, Schell glorifies the positivist vision using Mendeleev, but also presents game design as an art. One last example: in *Rules of play*, Salen and Zimmerman (2003) crafted their own definition of design, using, amongst others, Schön's and Simon's works. They argue that Simon emphasizes action while Schön emphasizes communication, and combine the two in a single perspective of design (Salen and Zimmerman, 2003, p.41). However, Simon and Schön have very different perspectives, and are generally seen as distinct; their theories are even considered as different paradigms (Dorst and Dijkhuis, 1995; Galle, 2011) for the epistemological reasons explained above (Simon leans towards positivism, and he stresses problem solving, while Schön defends a new epistemology of practice, and insists on the importance of problem setting).

From a design research perspective, all these examples are challenging, as they fail to fit into established epistemological perspectives.

These results appear to create a *mess*, a term that Bogost (2009) used to talk about videogames ontology (and inspired by John Law's work). For Bogost, recognizing the messy aspect of videogames was a call to celebrate the pluralistic vision of their ontology, and to abandon "the formalism of structuralist approaches" (Bogost, 2009), which he saw as a drift, or a trap. However, the epistemological mess does not necessarily pull game design research away from any trap. On the contrary, it seems to maintain the confusion; thus, I advocate instead for a movement of tidying up.

Recognizing the mess is an important first step, but it is not enough. A clear epistemological position is necessary to conduct research, as stated in design research: "Anyone wishing to make an academic contribution therefore needs to have this pluralistic perspective [about epistemology] in mind, because without recognizing the plurality and identifying the specific perspective, it is impossible to make an academic contribution." (Johansson-Sköldberg, Woodilla and Çetinkaya, 2013, p.132). More than trying to apply a method issued from other sciences, game design research could now try to understand the different possible epistemological perspectives. Several books try to fit in the model of the positivist epistemology of practice, but are confronted with dilemmas and so they craft their epistemology as they go, taking what fits their needs in the moment, without carefully considering the limits of each approach.

The mix of different epistemological perspectives might be interpreted as a lack a suitable epistemology to study game design. If taking into account the epistemological evolution in design research in general, some shortcomings emerge: design as an applied art mystifies the design and creative process; the positivist epistemology of practice is probably overly simplistic and restrictive; Schön's epistemology of practice seems promising, and is widely recognized in design research, but still needs to be more deeply adapted and questioned (Beck and Chiapello, 2016), especially for game design research. The latter is a project I am currently pursuing. These arguments could be taken in consideration in future attempts to explain game design activities.

Finally, finding an appropriate epistemological stance does not mean that all the other sciences have to be excluded, but that design should find "designerly ways of knowing" as Nigel Cross (2001) puts it. He concludes that:

Following Schön and others, many researchers in the design world have been realizing that design practice does indeed have its own strong and appropriate intellectual culture, and that we must avoid swamping our design research with different cultures imported either from the sciences or the arts. This does not mean that we completely ignore these other cultures. On the contrary, they have much stronger histories of inquiry, scholarship and research than we have in design. We need to draw upon those histories and traditions where appropriate, whilst building our own intellectual culture, acceptable and defensible in the world on its own terms. We have to be able to demonstrate that standards of rigor in our intellectual culture at least match those of the others. (Cross, 2001, p.54)

Sorting through the different design research epistemological frames and their applicability for game design would make it easier for game design students to find an approach that suits them, for teachers to explain the evolution of game design research, and for researchers to pursue expanding and building the field. It is time for game design research to show some maturity and clean up its mess.

ACKNOWLEDGEMENTS

I wish to thank prof. Rabah Bousbaci for his guidance, and Amy Oliver for her English editing. This research is funded by the FRQSC (Fonds de Recherche du Québec—Société et Culture)

BIBLIOGRAPHY

- Alexander, C., 1964. *Notes on the synthesis of form*. Harvard University Press.
- Alexander, C., Sara Ishikawa and Silverstein M., 1977. *A pattern language: towns, buildings, construction*. Oxford University Press.
- Bateman, C. and Boon R., 2005. *21st Century game design*. Charles River Media.
- Bayazit, N., 2004. Investigating design: A review of forty years of design research. *Design Issues*, 20(1), pp.16–29.
- Beck, J. and Chiapello L., 2016. Schön's legacy: Examining contemporary citation practices in design research Society Publications. In: *Proceedings of the 2016 Design Research Society Conference*. Brighton, England, 27–30 June 2016.
- Björk, S. and Holopainen J., 2004. *Patterns in game design*. Charles River Media.
- Björk, S., Lundgren S. and Holopainen J., 2003. Game design patterns. In: *Proceedings of the 2003 Digital Games Research Association Conference: Level Up*. Utrecht, 4–6 November 2003. pp.180-193.
- Bogost, I., 2009. Videogames are a Mess. In: *Proceedings of the Keynote speech at 2009 Digital Games Research Association Conference: Breaking New Ground: Innovation in Games, Play, Practice and Theory*. Brunel University, 1–4 September 2009.
- Borchers, J.O., 2001. A pattern approach to interaction design. *AI & Society*, 15(4), pp.359–376.
- Bousbaci, R., 2008. “Models of man” in design thinking: The “bounded rationality” episode. *Design Issues*, 24(4), pp.38-52.
- Brathwaite, B. and Schreiber I., 2009. *Challenges for game designers*. Charles River Media.
- Bunnin, N. and Yu J., 2004. *The Blackwell dictionary of western philosophy*. Blackwell Publishing.
- Bura, S., 2006. *A game grammar*. Available at: <<http://www.stephanebura.com/diagrams/>>.
- Burns, K., Ingram J. and Annable L., 2016. Mapping design knowledge: 36 years of Design Studies. In: *Proceedings of the 2016 design research society conference*. Brighton, England, 27–30 June.
- Chiapello, L., 2012. *Les casual games : définition à l'aide du savoir professionnel des designers de jeux*, M.Sc. A. Université de Montréal.
- Chiapello, L., 2013. Formalizing casual games: A study based on game designers' professional knowledge. In: *Proceedings of the 2013 Digital Games Research Association conference: DeFragging game studies*. Atlanta, GA, 25–29 August 2009.

- Church, D., 1999. Formal abstract design tools. *Gamasutra*, [online] Available at: <http://www.gamasutra.com/view/feature/131764/formal_abstract_design_tools.php>.
- Cook, D., 2007. The chemistry of game design. *Gamasutra*, [online] Available at: <http://www.gamasutra.com/view/feature/129948/the_chemistry_of_game_design.php>.
- Costikyan, G., 1994. I have no words and I must design. *Interactive Fantasy* (2). Available at: <<http://www.costik.com/nowords.html>>.
- Crawford, C., 1984. *The art of computer game design: Reflections of a master game designer*. Osborne/McGraw-Hill.
- Cross, N., 1981. The coming of post-industrial design. *Design Studies*, 2(1), pp.3–7.
- Cross, N., 2001. Designerly ways of knowing: Design discipline versus design science. *Design Issues*, 17(3), pp.49–55.
- Djaouti, D., 2013. Game design tools for collaboration. *Gamasutra*, [online] Available at: <http://www.gamasutra.com/view/feature/187777/game_design_tools_for_collaboration.php>.
- Djaouti, D., Alvarez J. and Jessel J.-P., 2010. Concevoir l'interactivité ludique: une vue d'ensemble des méthodologies de «Game Design». In: *Proceedings of the Ludovia 2010 conference*. Ariège-Pyrénées.
- Dormans, J., 2011. *Engineering emergence: Applied theory for game design*. PhD. University of Amsterdam.
- Dorst, K. and Dijkhuis J., 1995. Comparing paradigms for describing design activity. *Design Studies*, 16(2), pp.261–274.
- Findeli, A., 2005. Le Bauhaus: construire l'Homme pour construire le monde. In: J.-P.Chupin and C. Simonnet, eds., *Le projet tectonique*. Infolio Editions, pp.139–154.
- Findeli, A. and Bousbaci R., 2005. L'Eclipse de L'Objet dans les Théories du Projet en Design. In: *Proceedings of the EAD 06*. Brême, Allemagne, 29–31 March. pp.2–30.
- Fullerton, T., 2008. *Game design workshop: A playcentric approach to creating innovative games*. 2nd ed. Morgan Kaufmann.
- Galle, P., 2011., Foundational and instrumental design theory. *Design Issues*, 27(4), pp.81–94.
- Gamma, E., Helm R., Johnson R. and Vlissides J., 1994. *Elements of reusable object-oriented software*. Boston, MA: Addison-Wesley.
- Heiskanen, A. and Newman M., 1997. Bridging the gap between information systems research and practice: the reflective practitioner as a researcher. In: *Proceedings of the eighteenth international conference on information systems*. Atlanta, Georgia, United States, 14–17 December. Association for Information Systems, pp.121–132.
- Hunicke, R., LeBlanc M. and Zubek R., 2004. MDA: A formal approach to game design and game research. In: *Proceedings of the AAAI workshop on challenges in game AI, nineteenth national conference on artificial Intelligence*. San Jose, 25–26 July.

- Huynh-Kim-Bang, B., Wisdom J. and Labat J.-M., 2010. Design patterns in serious games: A blue print for combining fun and learning. *Project SE-SG*, [online] Available at: <[http://seriousgames/. lip6. fr/ DesignPatterns](http://seriousgames/.lip6.fr/DesignPatterns)>.
- Isbister, K., 2006. *Better game characters by design: A psychological approach*. Morgan Kaufmann Pub.
- Järvinen, A., 2008. *Games without frontiers: Theories and methods for game studies and design*, PhD. University of Tampere.
- Johansson-Sköldberg, U., Woodilla J. and Çetinkaya M., 2013. Design thinking: Past, present and possible futures. *Creativity and Innovation Management*, 22(2), pp.121–146.
- Jones, J.C., 1970. *Design Methods: seeds of human futures*. 1981. John Wiley & Sons.
- Juul, J., 2009. *A casual revolution Reinventing video games and their players*. Cambridge, MA: MIT Press.
- Koster, R., 2010. *Theory of fun for game design*. O'Reilly Media.
- Kreimeier, B., 2002. The case for game design patterns. *Gamasutra*, [online] Available at: http://www.gamasutra.com/view/feature/132649/the_case_for_game_design_patterns.php?print=1.
- Kuittinen, J. and Holopainen J., 2009. Some notes on the nature of game design. In: *Proceedings of the 2009 Digital Games Research Association conference: Breaking new ground: Innovation in games, play, practice and theory*. Brunel University, London, 1–4 September 2009.
- Kultima, A., 2009. Casual game design values. In: *Proceedings of the 13th International MindTrek conference: Everyday life in the ubiquitous era*. Tampere, Finland, September – October 02. ACM, pp.58–65.
- Lecky-Thompson, G.W., 2008. *Video game design revealed*. Charles River Media.
- McEntee, C., 2012. Rayman Origins post mortem. *Game Developer*. UBM TechWeb, pp. 26–31.
- McGee, K., 2007. Patterns and computer game design innovation. In: *Proceedings of the 4th Australasian conference on interactive entertainment*. RMIT University, Melbourne, 3–5 December. p.16.
- McMillan, L., 2013. The rational design handbook: An intro to RLD. *Gamasutra*, [online] Available at: <http://www.gamasutra.com/blogs/LukeMcMillan/20130806/197147/The_Rational_Design_Handbook_An_Intro_to_RLD.php>.
- O'Donnell, C., 2014. *Developer's dilemma The secret world of videogame creators*. MIT press.
- Olsson, C.M., Björk S. and Dahlskog S., 2014. The conceptual relationship model: understanding patterns and mechanics in game design. In: *Proceedings of the 2014 Digital Games Research Association conference: <Verb that ends in 'ing'> the <noun> of Game <plural noun>*. Snowbird, UT, 3–6 August.
- Rasool, G., Khan M. and Hussain S., 2015. A systematic literature review on mobile games design patterns. *Science International (Lahore)*, 27(2), pp.1365–1372.
- Rittel, H., 1973. The state of the art in design methods. *Design Research and Methods*, 7(2), pp.143–147.

- Rittel, H.W.J. and Webber M.M., 1984. Planning problems are wicked problems. In: N. Cross ed. *Developments in design methodology*. John Wiley & Sons, pp.135–144.
- Rogers, S., 2010. *Level Up!: The guide to great video game design*. Wiley.
- Rollings, A. and Morris D., 2004. *Game architecture and design: a new edition*. New Riders
- Rouse III, R., 2010. *Game design: Theory and practice*. Jones & Bartlett Learning.
- Salen, K. and Zimmerman E., 2003. *Rules of play Game design fundamentals*. Cambridge, MA: MIT Press.
- Salmond, M., 2016. *Video game design: Principles and practices from the ground up*. London, UK: Bloomsbury Publishing.
- Saltzman, M., 1999. *Game design: Secrets of the sages*. Macmillan Digital Publishing.
- Schell, J., 2008. *The Art of game design: A book of lenses*. Burlington, MA: Elsevier, Inc.
- Schön, D., 1983. *The reflective practitioner: How professionals think in action*. Basic Books.
- Schön, D., 1992. The theory of inquiry: Dewey's legacy to education. *Curriculum Inquiry*, 22(2), pp.119–139.
- Seamon, D., 2007. Christopher Alexander and a phenomenology of wholeness. In: *Proceedings of the annual meeting of the Environmental Design Research Association (EDRA)*. Sacramento, CA, 30 May – 3 June.
- Sharp, H., Manns M.L. and Eckstein J., 2003. Evolving pedagogical patterns: The work of the pedagogical patterns project. *Computer Science Education*, 13(4), pp.315–330.
- Simon, H.A., 1969. *The Science of the Artificial*, 3rd ed. 1996. MIT Press.
- Simpson, Z.B., 1998-1999. Design pattern for computer games. In: *Proceedings of the Computer Game Developer's conference*. Austin, TX; San Jose, CA.
- Will, C., 2013. *A pattern language for designing location-based games*, Diploma thesis. RWTH Aachen University.
- Willson, M. and Leaver T., eds., 2016. *Social, casual and mobile games: The changing gaming landscape*. New Bloomsbury Publishing USA.

CHAPTER 2

MULTIDISCIPLINARY GAME DESIGN RESEARCH

ONTOLOGIES AND OTHER REMARKS

ANNAKAISA KULTIMA

In 2016, at the joint conference of Digital Games Research Association (DiGRA) and Foundations of Digital Games (FDG), I participated in a panel of six game scholars. We all gave our short presentations on different perspectives of game design, business and development. The panel was titled *Production studies—why now?* and the discussion that followed was both rich and lively. However, the session left me reflecting how hard it has been, and still seems to be, to convince the importance of studying *game design as practice* and *games as created*. Especially today, in the era of the success stories of the game industry, it feels alien to encourage game scholars to “go outside the library”, as Sebastian Deterding put it during the panel discussion. Why do we need encouragement? Why do we need to question this? What has led us game scholars to this situation?

For the past ten years, my research (e.g., Kultima et al., 2016; Kultima and Sandoval, 2016; Kultima, 2015; Kultima and Alha, 2011; Kultima and Alha, 2010; Kultima, 2010) has concentrated on understanding the practice of game developers from the perspective of creativity and innovation—highlighting the experiences of average game developers. It is important to admit that, even though some of us have been outside the library for a long time now, the amount of work remaining is enormous. After nearly two decades of neglect, the study of digital games is deeply short on theories, conceptual tools, methodological understanding and critical approaches for dissecting the praxiology of the art that we so dearly appreciate. We have been focused in studying the artefact and the user—leaving the creators in the shadows. If we are to study games and play as a whole, we should look at game design from all relevant perspectives.

This book draws upon the notion of *design research*, an academic framework that I too am happy to utilize. Design research provides a range of versatile approaches and methods, facilitating the study of games as designed. The disciplinary home of design research took some time for me to find, and I only wish that books like this would have existed before I started my research. Like many of us within the multidiscipline of game studies, I have had to take several steps outside my disciplinary comfort zone as there was simply no game studies when I started my university classes. After searching the fields of creativity research (i.e. psychology and educational sciences), innovation studies (i.e. management studies) and game studies (i.e. techno-humanistic study of digital play), I have found the vocabulary, perspectives and theories born within the traditions of architecture, industrial design and engineering the most useful for the research questions that I have been interested in.

ONTOLOGIES OF THE YEAR ONE OF GAME STUDIES

In 2001, Espen Aarseth (2001), the Editor-in-Chief of Game Studies wrote that the year 2001 can be seen as the “Year One of Computer Game Studies as an emerging, viable, international, academic field.” Aarseth claimed game studies to be an independent academic structure, not to be reduced to any of the existing fields (Aarseth, 2001). Since then, there has been a surge of papers and projects looking at games and players from various perspectives following a good number of conferences, seminars and other academic events (Melcer, et al., 2015; Mäyrä, Van Looy and Quandt, 2013). Studying games is no longer the lonely endeavor of the few.

The declaration of computer game studies has since elevated different kinds of definitional discussions, reflecting the theoretical borders of the subject as well as charting what is relevant to study. In 2008, Staffan Björk (2008) wrote how the “interest in research on game-related topics has grown strongly in recent years following the widespread success of computer games as cultural and commercial phenomena” and how “a certain level of friction has existed regarding what constitute proper methods and research questions”. Björk suggested an “axis mundi” for game research: for him, different research interests within the rising academic field were easily mapped onto the three concepts of *games*, *gamers* and *gaming*. Also in 2008, Frans Mäyrä conceptualized how the focus of game studies lies in the interaction between game and player, informed by their various contextual frames. In his introductory book to game studies (Mäyrä, 2008) the intersecting views were grouped into 1) study of games, 2) study of players, and the 3) study of the contexts of the previous two.

It is typical that the labels of *game studies*, *games research* or *game research* are mostly used interchangeably within the community of game scholars. Depending on their backgrounds, researchers might prefer one over another. Game scholars have varying disciplinary homes and put together, we form an interesting interdiscipline (Deterding, 2014; 2016). While constructing his “year one” declaration, Aarseth (2001) referred to the important and inevitable multitude of contributing disciplines as “we all enter this field from somewhere else”. He listed such fields as anthropology, sociology, narratology, semiotics and film studies as examples of academic origins of game researchers.

In addition to providing a richness to the community, the multi- and interdisciplinary nature of game studies can also be thought to present something of a challenge (Waern and Zagal, 2013; Mäyrä, 2008; Mäyrä, 2009). Digital games especially call for a collaboration between different academic interests. In his reflections of multidisciplinary research work Mäyrä (2009) lists combinations of researchers from humanities and social sciences, as well as the combination of socio-cultural game studies with technical or engineering-oriented research, as examples of such collaboration. To Mäyrä, these multidisciplinary research projects have been fruitful and the approach has proven to be a good survival tactic, but he also concludes that the role of interdisciplinarity in game studies is somewhat mixed and ambiguous (Mäyrä, 2009).

The nature of the scientific practice of game studies is wide. Mäyrä, Van Looy and Quandt (2013) conducted a survey on the game research communities of DiGRA, ECREA and ICA, enquiring as to their disciplinary background, current research field, and identification as “digital games researcher” among other issues. They concluded that there is no single disciplinary field that would play a key role for organizing the academic identity of contemporary games researchers and that the research on both games and play is highly multidisciplinary and dynamic (Mäyrä, Van Looy and Quandt, 2013). However, reflecting on the background factors does not provide the whole picture of the academic community.

Many reflections on game studies are narrow and naturally affected by the personal academic interests of the scholars themselves. Aarseth's (2001) early manifesto for game studies was predominantly from a perspective which mixed humanistic and social sciences. The categories and ontologies of game studies by Mäyrä (2008) as well as Björk (2008) and others (e.g., Juul, 2005) model the research interests of game scholars around the artefact and the users—leaving the other issues as simply constituting “context” (Mäyrä), “world” (Juul) or just the interplay of these two (Björk). Such an ontological stance seems to be in direct relation to a lack of understanding of both the wider spectrum of design in games and a systematic exploration of design processes.

Interdisciplinary research can be challenging for various reasons. Sebastian Deterding (2014; 2016) explains how the “friction” highlighted by Björk (2008) is not unique to game studies, and how in general the “initially enthusiastic interdisciplines and young interdisciplinary researchers” quickly encounter various challenges, including friction resulting from incompatible epistemic cultures. By dissecting the models of overcoming the disciplinary boundaries into multi-, trans- and interdisciplinarity of different levels, Deterding characterizes game studies as a narrow interdiscipline or even encyclopedic multidiscipline at its best. Further, he argues that the current development and direction of the field can be considered as narrowing or differentiating into multiple sub-communities—just like any other maturing interdisciplines (Deterding, 2014). The multitude of issues in game studies do not end up as a wide spectrum within a larger view of the scientific community.

Interestingly, *design* is one of the words that brings us together. Melcer, et al. (2015) conducted a data driven examination of the 15 years of modern game research. By evaluating the keywords of over 8000 game research papers, they identified 20 major research themes and seven distinct sub-communities. Their results support the commonly held assumption that games research has different clusters of papers and venues for technical versus non-technical research. The most popular keyword in game research papers examined by Melcer, et al. (2015) was *game design*.

As Deterding (2014) implies, it is not the background factors of the entire community that defines an interdiscipline; the canon of game studies was crafted by narrow group of academic actors and many of the defining handbooks and introductions are “unanimously written by designers and humanities scholars” (Deterding, 2014). It could be argued that the so called *ludological approach* has justified such concepts as game and play as constituting the atoms of academic discussions. It is somewhat typical that a game research paper uses the metaphor of play or games as a model for the examined phenomenon, be it a phenomenon of culture, economy, social interactions, creativity or any other. Perhaps there is something exhilarating for a game researcher to be able to fortify the non-reductionist ludological stance initiated by Aarseth (2001) by reducing other phenomena, often having already been widely researched, into the vocabulary of game studies. A narrower view has, undoubtedly, also been a practical choice and has made it possible for the researchers to communicate despite varied backgrounds.

Deterding (2014) suggests that we should consider *design orientation* as one of the possible future directions in the interdiscipline of game studies. In his view, an orientation towards instrumental utilization of game research through designed artefacts holds promise for the growth and sustainability of game research. But it seems that this view lacks the wider spectrum of *game design*; Deterding holds a specific view of design as a problem-solving activity (cf. Dorst and Dijkhuis, 1995). The promise of game studies as an interdisciplinary effort is depicted as a contributing factor to the societal impact of game research and education, mainly in solving design problems. Design orientation in game studies should reflect a wider understanding of design research in general, not

just one view. Design research is not just one thing, as such neither is game research. The depth of the term *design* is as multi-faceted as that of the more familiar *game* and *play*. We need to include *design* as part of the ontology of game studies, not as an applied part of game studies, but equal to other similarly complex concepts.

EPISTEMIC CULTURES AND THE ONTOLOGIES OF DESIGN RESEARCH

Studying design independently from other phenomena is relatively young field in itself. According to Nigel Cross (2007), the editor-in-chief of *Design Studies*, the desire to “scientise” design emerged as early as the 1920s and resurfaced in the design methods movement of the 1960s. Cross (2007) discusses how terms such as *design science* and *science of design* bear a different meaning: the former refers to a search for a single method for science-like design and the latter to the study of designing as an academic endeavor. According to Cross (2007), the modern term *design research* implies a goal of “development, articulation and communication of design knowledge”. Furthermore, the sources of such knowledge to him are to be found in people, processes and products. His taxonomy of design research falls into three main categories: design epistemology (study of designerly ways of knowing), design praxiology (study of the practices and processes of design) and design phenomenology (study of the form and configuration of artefacts). If we utilize Cross’s taxonomy, we could further reinforce the argument that the study of game design is lacking in a number of areas. Even though much of the research conducted in game studies could be placed under the umbrella of design phenomenology, and some of the technology and industry studies under the design praxiology, we are still lacking a detailed look at the processes of individual developers and the views of design cognition.

Within general design research, the special nature of design cognition is highlighted—an approach we too should adopt. For instance, Kuutti (2009) discusses how the values of scientific knowledge differ from design knowledge in one important manner: whereas scientific knowledge is often timeless and general, design knowledge is particular, local and timely. We also utilize classical knowledge in design processes, but the particularity and idiosyncratic are often a critical part of the design. This brings an interesting twist to design epistemologies and “designerly ways of knowing” (Cross, 2007). However, both are needed. Bonsiepe (2007) discusses the fact that there is a special kind of interplay between research and practice. To him, “designers can no longer design the way they did one or two generations ago” and “researchers can no longer do research as they did one or two generations ago.”

The nature of design research can also be found in other ontologies for design research. Perhaps one of the most famous and often used typologies is that of Christopher Frayling (1993). Frayling divides research into three different categories: research for, into, and through (art and) design. Sato (2009) also differentiates two ways of using the concept of design research. According to Sato, design research can have at least two distinctive meanings; on one hand it might denote the practice of developing information for a particular design project, and on the other hand it indicates the practice of developing a generalized and structured body of knowledge (academic research). Furthermore, Sato’s typology for design research divides academic design research into theoretical research, methodological research, experimental research, field research and case studies (Sato, 2009).

Along similar lines, Bonsiepe (2007) distinguishes endogenous and exogenous design research. Endogenous design research is initiated spontaneously from within the field of design, whereas exogenous design research is interested in design as an object of scientific inquiry. For Bonsiepe, endogenous design research is primarily instrumental and tied to design projects and embedded into the design processes similar to Sato (2009). However, Bonsiepe hopes that endogenous design

research will eventually reach for a more general level of knowledge, one similar to exogenous design research. For Bonsiepe, the danger of exogenous research is to fall into the normative account of design disconnected from practice (Bonsiepe, 2007). The ontologies of design research expand the view of the interdiscipline towards, not only *what to study*, but also *why to study*, *how to study*, and who is part of the knowledge creation.

As highlighted by Bonsiepe (2007), design research can be conducted within companies and studios, as well as in academic institutions such as universities and research centers. Since there have been relatively few academic studies on game design processes, it is typical that the scholars have utilized professional literature (for example, Fullerton, 2008; Salen and Zimmerman, 2003; Schell, 2008) as sources. There has also been a significant amount of direct collaboration between the industry and the academia. Mäyrä, Van Looy and Quandt (2013) examined the nature of the game researchers' collaboration as one of the defining background factors: As many as 39 % of the respondents (n=544) reported having some sort of research collaboration with the industry. In addition, the communities of game scholars and developers are overlapping with each other socially. Some practicing game researchers are game developers themselves (for example, Casey O' Donnell) and some game developers might have later turned towards an academic career (for example, Ernest Adams). Due to the shared interests on games, researchers and developers also socialize with each other. We could argue, that game scholars are relatively close to the industry and the nature of the studies in Bonsiepe's terms (endogeneous and exogeneous) can play together and inform each other.

Game research is conducted both within the interdisciplinary academic communities as well as increasingly among established disciplines of academia, further nurturing epistemic communities that have no connection to the practitioners at all. Even though some game developers do follow academic studies, it is more typical, that the practitioners have no connection to game research. Independently to academic epistemic communities, game developers construct new knowledge in order to pursue new technologies, improve the performance of existing technologies, understanding new and existing user groups, and to tweak their design in many opportunistic ways. These latter non-academic epistemic communities, and the knowledge creation processes of the developers, have not been studied rigorously, if at all. Even though there is some interplay between the epistemic communities, we cannot assume that the gap between research and design (cf. Bonsiepe, 2007) does not exist in games.

There are, however, reasons for this gap: as the game industry moves forward and tools and trends change in a rapid manner, the conventional methods for learning and knowledge creation do not always apply. Much of the cognitive processes happen in networked communities and knowledge is shared in various seminars and conferences. These might also be good sources for scholars to seek knowledge on the processes and tools. In the US, such conferences as the *Game developers conference* (GDC), held annually in San Francisco, can be relevant to game design researchers for various reasons. The areas of interest are shared with the developers, even though the social processes of forming and evaluating knowledge might differ. Additionally, there is a lack of good sources of information on the emerging design areas and the topics change and transform rapidly, making it difficult for an academic approach. Industry conferences are also excellent places for deeper discussions with industry practitioners. Other notable conferences are *Casual connect* in Europe and the US, and the annual *Nordic game conference* in Sweden, bringing together the Northern European game developers, students, and educators. Similar venues are spread around the calendar year and around the globe to the extent that it is hard to miss an opportunity nowadays.

Another source of information provided by the game industry are the industry reports about the salaries of the developers, the growth of the industry, the players of certain games and mixed topics white papers. For instance, in Finland, an annual report of the state of the national games industry is provided by a non-profit and non-academic game industry organization, Neogames (e.g., Hiltunen, et al., 2017). Such reports have been criticized in academic use, since similar to the Gamasutra.com design postmortems, the publication values differ to those of academia.

Much of the everyday knowledge work of game developers is facilitated by modern information society; different online publications and forums provide good sources and tools for the developers, an example of which is the *GDC vault*. UBM Tech, as the owner of the GDC conference brand, also maintains an online magazine, Gamasutra.com, which collects professionals' views on their products and processes, aggregating hundreds of developer blogs. Such a library of developers' views on their art is also valuable for future game research. A popular data set drawn from Gamasutra.com (and *Game developers magazine*) is that of *game design postmortems*, where the developers dissect their development process publicly into "What went wrong?" and "What went right?" The epistemic usefulness and reliability is a matter of literacy skills for the both parties. Rami Ismail, an indie game developer, in his keynote for *Pocket gamer connects Helsinki* conference in 2015 stated that the game industry is moving fast and the speeches by industry actors hold true for a particular game project on a particular platform and in a particular slice of time. He encouraged his peers to go to the talks, but to form their own opinion by putting together the pieces of information as trends rather than interpreting the lessons as universal claims.

Game developers also use Google searches to solve their particular problems in daily design work (Kultima, et al., 2016). If the Internet is not helping or if the answer is not found within the same studio, the developers can ask from their peers in social media, in meetings, or by giving a call. It is important for game developers, especially those in small studios, to network. What is typical of such accounts is that expert knowledge is shared almost "by the hour" and much is quickly outdated and far from researched. Following the academic values of conducting research, many of the topics could take too long to survey. Despite their suspect reliability, some of the presentations and publications hold an invaluable role as records for the future history of game development. This echoes well with the notion of the "artifact knowledge" by Kuutti (2009). If there was not already enough to contend with juggling the varying epistemic cultures between the academic disciplines, game research as design research seems to have another interesting epistemic challenge to consider: that of design knowledge.

The epistemic needs of game developers might differ from that of a game scholar. The way in which the knowledge is constructed, evaluated and shared is different and these two epistemic communities sometimes even espouse contradictory values. The uneasy relationship between academia and practice is visible also in reflections on design research in general. Blessing and Chakrabarti (2009) identified the common challenges of design research as consisting of:

1. lack of overview of existing research
2. lack of use of results in practice
3. lack of scientific rigor (Blessing and Chakrabarti, 2009).

It could be argued that the issues outlined by Blessing and Chakrabarti (2009) can be connected to the challenges of many interdisciplinary efforts. The challenge of the interdisciplinary, which also includes building relationships with non-academic disciplines, highlighted by Cross (2007), is a familiar one to any of the contemporary game researchers. A factor potentially further contributing

to the slow progress of game design research is the lack of shared understanding of general design theories; instead, knowledge seems to be gathered direct from design guidebooks. Sometimes it might feel uncomfortable for a researcher to “step outside the libraries” and many researchers might be less relaxed with methods that include those challenges described above. Furthermore, if we accept that the wider epistemic community incorporates non-academics as part of the knowledge construction process, then such variety exists naturally; we do not need only to understand the different methods and to evaluate them in the academic context, but also occasionally to separate what kind of knowledge interest there is for the epistemic processes. Sometimes practitioners are superior sources for the information due to their better access to the internal design processes.

FROM THE SECRET LIVES OF GAME DEVELOPERS TO THE PROMISE OF GAME JAMS

For a rigorous academic exploration, it is important that we have better access to the processes at large. One reason why game studies have not included an extensive look into the practice of game developers is that it has been relatively difficult to access. It might be hard to access the design processes from an academic perspective, especially in the long term. Casey O'Donnell (2014) has discussed the lack of openness and collaboration fostered by the highly restrictive legal agreements and sense of secrecy that dominate the videogame network. The access and practicalities of conducting design research in the field, as also presented by Lawson (2004), are forcing researchers to conduct work in studios that happen to be available and sufficiently open to outsiders, as well as conducting research on students and developers beginning their careers. If we are to welcome the interplay of non-academic and academic epistemic communities, we should try to work on alternative solutions.

One solution to the issue of access is to turn to the study of game jams. For the past several years, the body of knowledge within game jam research has been growing rapidly (Kultima, 2015). Game jams have gained relatively wide interest from the academic community of game researchers. As an evolving area of academic interest, game jams have been commented on, researched from different angles, and used as a platform for varying studies (Fowler, Khosmood and Arya, 2013; Fowler, et al., 2013).

Game jams can be framed as “compressed development processes” (Zook and Riedl, 2013); this perspective is one of the key reasons for the growing academic interest in the format. Being able to go through different steps of game development in a short period of time makes game jams an attractive platform for research into game development and design. Fowler, Khosmood and Arya (2013) highlight such potential by naming *Global game jam* (GGJ) “a new kind of research platform” and further setting a promise of it providing “a unique opportunity for studying different professional, educational and cultural aspects of computer games”. Supporting the claim of potential, game jams have also been touted as “a design research method, situated in the research-through-design tradition” (Deen, et al., 2014). Particular research interests and utilization strategies vary: for instance, Musil, et al. (2010) investigated game jams as a general format of prototyping to gain better understanding on prototyping practices in software development processes, while Scott and Ghinea (2013) have been interested in game jams as an opportunity for educating game makers on the issues of accessibility in games.

Many researchers utilize *Global game jam* as a platform for game jam studies. The size and reach of GGJ has provided unique opportunities in comparing the cultural differences of game development. Yamane (2013) reported the introduction of *Global game jam* in Japan with a claim that “many

Japanese jam attendees were not well-acquainted with the practice of the participatory design or prototyping well before the Global Game Jam”. It seems that game jams can act as a way to amplify teaching of certain design paradigms within game curricula. This has been further confirmed by Preston, et al. (2012), who found a positive correlation between game jam participation and formal academic performance in game education.

GGJ has been advertised as a game development event focusing on creativity, experimentation and innovation (Global Game Jam, 2015), which has encouraged researchers and developers interested in game innovation to turn to GGJ and other game jam events. For example, Zook and Riedl (2013) studied the GGJ 2013 participants’ design inspirations and goals in order to add to the understanding of the relationships between design processes and development outcomes. Ho, Tomitsch and Bednarz (2014) investigated the connectivity of ideas and the inspiration network within GGJ 2014. Contributing to the same field of inquiry, Kultima and Alha (2011) used GGJ 2010 and GGJ 2011 as a platform for studying brainstorming methods for game development.

In 2006, Fullerton, et al. (2006) commented on how game jam participants’ “eager engagement” has been motivated by “the enthusiastic search for new ideas”, yet few proved successful in their endeavors. This realization further made them deem game jams as being a tool for “small innovative ‘flashes’ that would need a secondary level of longer term research to foster and iterate on these flash ideas.” Whether or not game jams actually function as a tool for innovation, jams have found their relevance in connection to the game industry. In 2013, Turner, Thomas and Owen (2013) described game jams as “an important rite of passage and baptism event for students looking to enter the industry [...]”, adding that “something very unique happens within a game jam and that this ‘something special’ is an important aspect of the potential future life of a vibrant games industry.” Reng, Schoenau-Fog and Kofoed (2013) also emphasize the role of game jams as social events; studying *Nordic game jam 2013*, they concluded that while the interest in developing the game itself plays a large role, it is mixed with an interest in socializing with other game developers and being part of the community. These aspects are important to remember if we are to use game jams as windows into game development.

Certain challenges arise for academic endeavors when researching such a volatile and widely spread phenomenon as the game jam scene. Events can differ in terms of rules, context and setting, stimuli, guidance, time frame, and objective. Game jamming is also a relatively new phenomenon, and we lack comprehensive understanding of the format and the differences between the events. Even though the phenomenon of game jams is in a state of flux, some degree of clarity in the concept would benefit future research collaborations. How much of our research in game jams is comparable? Which issues in game jams are essential for the achieved results? Which topics can be attributed to the format and which to the context or specific details? How much does the game jam situation differ from other developmental practices and experiences (cf. Kultima, et al., 2016)? We must be careful when resorting to game jams in order to gain understanding of game development and production. Game jams are not a simulation of commercial game development or, more broadly, a simulation of the wide spectrum of game design, but they are instead a distinct phenomenon. It does not offer easy access to the research topic, but instead enlarges the view that we should take—to study game making also as a hobby and as various cultures of creation. At the same time, there is promise in the access, we must realize that there are even more ontologies that we should be covering in order to understand games as created.

Furthermore, we should learn from other domains of design. In the quest to improve general design research, Lawson and Dorst (2009) have studied the development of design expertise. They note that it is important to take the level of expertise into an account when studying the sometimes impenetrable design practices. The game industry is still in its first couple of generations, yet we could already begin to talk about levels of expertise that vary between junior developers (not to mention aspiring developers and students)—and very experienced developers. The technological developments and other changes in the industry have forced developers to adopt a process of constant learning, as well as by choice: they have purposely decided to work on something new (Kultima and Alha, 2010). Design skill formation theories are yet to be fully implemented into our works within the field of game studies in order to understand this further. It is important to continue studying the same issues, with more experienced developers as the industry matures. One look at a changing phenomenon does not provide enough depth to the issue, but we are severely lacking in longitudinal studies of game development practices.

As the industry matures, the expertise levels will differ and it makes a difference when choosing to study one group over another. Different companies, collectives and other groups will nurture different design cultures. The attitudes, perspectives and varying interests of the practitioners towards games will shape their realities and it is important to acknowledge that comparisons can be difficult to do without raised awareness of this multitude. For us researchers, it is important to understand the backgrounds and the evolutionary paths of our interviewees. We are lagging behind in our efforts to chart these differences, things that could be also done with very conventional research methods, as such we are lacking in frameworks and context to guide reflection for the results of our research. It is difficult to identify what is different or has changed when we do not have anything to compare to—and this is naturally amplified by the changing platforms of our phenomenon. We need to be better in covering growing ontologies of phenomenon and utilize several theoretical frameworks to chart the view of game design as practice and games as created.

THE PLURALISTIC NATURE OF DESIGN AND THE EXPANSION OF LUDOSPHERE

The ontologies proposed by Björk (2008) and Mäyrä (2008) are not the only affecting atoms of the game studies. As a multidiscipline, we are probably utilizing several overlapping and sometimes dissonant ontologies depending on our various disciplinary backgrounds—they most naturally work in the background, and we usually only discover them through friction and conflict. However, what we have at hand in the third wave (Juul, 2002) of game research, is only one side of the picture. Stenros and Kultima (forthcoming) argue how, in order to look into the future of game studies, one should be aware of the wide spectrum of games and play research. Reviewing the history of game research published in the *Simulation & Gaming* (Crookall, 2000), already consist of more than three decades' worth of work. These trajectories were completely ignored on Aarseth's manifest. It is also somewhat interesting to ask what the background issues actually are, that can account for the neglect of the creator in game studies. We could, for instance, look at the echoes of the theoretical and ontological developments of literature studies (affecting many pioneers on the game studies community), as Deterding pointed out during the panel discussion at FDG and DiGRA 2016. Also to some extent, the ontologies of game studies concentrate more to the ontologies provided by the digital games—not necessarily of *play* or *games* in general.

As Kuutti (2007) discusses, there is also value in such particularities. In some cases, it might be awkward to study all design processes and phenomena with the same framework. The nature of design knowledge also makes us embrace the idiosyncratic findings more familiar to humanistic

methodologies. There are many interesting peculiarities in games and play cultures from which we can learn, and the constant strive for diversity is a great source of creativity; games as designed can be for, and from, many.

The sphere of digital games and play has undergone many changes over the past decades. Often, these changes have been due to technological advancements, but also advances in methods, tools and processes as well as markets and business logic. Digital games are not a rarity anymore and they do not stand at the margins of the human culture, but have gained more exposure, evoked discussions as well as earned economic relevance. Changes in design practices can be very fruitful for researchers. For instance, the casual turn (Kultima, 2009) in games made visible the fact that design processes are guided by a set of values that can be different from one production to another. The possibility space in design is wide and, depending on the goals, design decisions differ. I have elaborated this view further (Kultima and Sandovar, 2016) arguing that such multitude in the design possibilities also leads to the possibility of pluralistic design values. It is important to understand, that as games can be many, they can be also valued from many different angles and also that the active creators might create them to satisfy different motivations. This is an important issue for game scholars to understand and reflect upon their own values when studying games from multiple perspectives (Kultima and Sandovar, 2016).

The phenomenon of games and play also relates to non-digital media and has been expanding into areas other than those that simply regard games as artefacts. The topic of gamification (Deterding, et al., 2011; Huotari and Hamari, 2012) has become popular among game scholars, as has the ludification of the society and perhaps further developments of these perspectives such as, toyification (see Heljakka, 2016). Through these notions – the area of academic interest of games and play are ever widening. Stenros and Kultima (forthcoming) discusses this expansion of the phenomenon as *expansion of ludosphere*. Games and play are deeply intertwined phenomenon in our modern society. As the sphere of digital games mature, we are able to more clearly see the different valuations, such as the valuation of artefact over creator or playability over esotericism and art in games. But, additionally, it may be that in the future design theories in games and the different schools of thought similar to Dorst and Dijkhuis (1993) can also develop in the field of games (Kultima, 2015). Instead of finding one clean ontology for all of us to abide by, we should have more tools to reflect on the pluralism that we are inevitably facing. The sphere of ludos and playful design is broadening, not becoming narrower.

DESIGN RESEARCH, PRODUCTION STUDIES OR LUDOURCES?

The growth of the game industry has made us think more about the integral role of the game developers as a professional community as well as tax-payers and employers. We do not merely consume games as ever-green artefacts in the manner of *chess* and *mahjong*, but more timely individual and artistic views distilled in games, such as *That dragon, cancer* (Numinous Games, 2016) or *Depression quest* (Quinn, 2013). We celebrate games as part of the political economy of particular countries as the success of the big companies create jobs as well as tax income. Games touch our lives on multiple levels—and that is not all about the game experience and the gamer cultures. As games are more openly discussed in various media, we are perhaps becoming more interested in those who create the games and why, and in what kind of responsibilities these people have to their players and employees. We are also interested in how to sustain such practices and nurture creative cultures of the future creators.

To investigate these issues, some scholars prefer to place themselves under the umbrella of production studies or studio studies (for example, O'Donnell, 2014; Kerr, 2017; Banks, 2013). In order to understand games deeply it is important to use and further develop notions and theories of, for instance, labor and economy as the game industry is at the same time a very atypical, modern place of work while also part of the work life in general, subject to the same legislations and effects of the surrounding societies. As an understudied topic, game work and game productions deserve a wider understanding of how the multifaceted phenomenon of game industry as a creative industry works, how people are managed, and how this all happens in a particular socio-economic environment. This further enforces the need that game studies has in order to continue embracing the interdisciplinary work of understanding games and play more deeply. This will, however, continue to bring new and diverse ontologies from different intellectual communities and it does produce more pressure to educate the future scholars into the wider understanding of the problems and processes of interdisciplinary work.

However, one thing is important to note: even though the frame of production studies or other frames are necessary, they are not reductionist tools. Concentrating solely on ontologies of production for instance, we might yet end up with a narrow perspective and lack understanding of the wider ecosystem of games. If we think about games as created, we should also be aware that not all games are tied to commerce, or at least not in the same way. We must acknowledge that some game creators are willing to work in ways unconnected to business development in order to sustain their hobby, or to tread a less money-oriented path. In the future, game design research needs to be able to specify whether one is looking at the topic of hobby culture, students and game education, art scene, professional communities, or even exceptional talents. And these, of course, are all interconnected.

Similarly, many other disciplines, and overlapping interdisciplines also affect the way we study games and, additionally, how we will be studying games as created. Together these form a complex whole. One of the interesting points of design research is that it is trying to push new concepts into the epistemological and philosophy of science discussions. Some underpinnings of design knowledge challenge the way we think about science and scientific knowledge work. What have been advanced in other fields have naturally been to satisfy the needs of the particular ontologies of research in those fields. The notion of the design cognition is central to the whole of design research, but the need and the problematics of interdiscipline are current issues. The reflective discussion of the field of design research has called for different kinds of views that have relevance to other fields of research—and that of course includes any field that also deals with issues of design, such as game studies (cf. Melcer, et al., 2015). The conglomerate nature of the term *design* is akin to the profoundness of *play*.

Bonsiepe (2007) has claimed that “designers can no longer design the way they did one or two generations ago, then it must also be acknowledged that researchers can no longer do research as they did one or two generations ago.” He is addressing the way in which the complexities of modern society have pushed a change in the way we mediate information, which can be touted as an iconic turn. We have been dominated by the “centuries-old tradition of verbocentrism”. The hope of the future is in being able to explore the cognitive potential of visual design and to adequately characterize the indispensable role that visual design plays in the cognitive process. Thus, we should acknowledge the cognitive status of images and above all, of *visuality*. He is further noting how a deeply rooted prejudice against images is evident in the fact that they are so often downgraded with the adjective beautiful, revealing a visceral distrust of anything that betrays even a trace of aesthetic sensitivity. Instead we are fixated on verbal communications pushing visual into anti-aesthetic attitudes or indifference. In the practice of design, however the role of visual is central and unavoidable.

Interestingly perhaps, one could discuss that the notion of interactivity is epistemologically as essential for games as the visual is for graphic design or the design of objects. The verbo-centric dominance can also be observed in the many changes in the field of game development. The role of design documents, for instance, has been diminishing (cf. Hagen, 2012) and the role of prototypes and practice of prototyping has become more central, some of which is also visible in the movement of game jams (Yamane, 2013).

In game studies, an effect of the ludological agenda has been to highlight the need to study games as games – also through playing. We value the audio-visual works of game developers but are still content with the traditional academic verbo-centric tools. It is baffling how little we utilize visual material or even screenshots and videos of games; I dare everyone to think beyond such a restricted approach. If Bonsiepe is arguing towards *viscourses* (discussions through visuals), we could further argue that in the future, we need more tools that facilitate discussion through playful formats, even games. In addition to *viscourses* we should be talking in terms of *ludources* (Stenros and Kultima, forthcoming). How can we develop the field of academic communication and studies with the help of the ludological perspective and build upon design research even more? Such endeavor also calls for critical evaluation; we should not just be using the terms of game and play because they happen to be there, but because it is necessary to advance into such concepts due to the conceptual need.

After the 2016 panel *Production studies—why now?* I felt deeply blue. Even though the discussion was rich and eager, I felt that my beloved goal of studying games as created was overshadowed by the discussion of games as industry. Many game scholars have the pressure of teaching their students to become avid players of the industry and their funding might also be tied to the trends and topics that the economic success of the game industry is pushing for. This directs the academic discussion in the same way that it directs the discussion within the practitioner communities. We are in the boom of game ecosystem where people's perspectives are short-sighted and narrow. An academic perspective should also be one which extends over longer periods of time, one which can look at the bigger picture of the phenomenon. As already discussed above, there is so much academic work left undone. It is hard to maintain a positive view when the resources are scarce.

However, I believe that the future of game design research is bright and that we also have a lot to offer the general study of design. There are more and more young scholars interested in studying the practice of game developers and creators—we will be advancing with the body of knowledge on game design praxiology understanding games more thoroughly as created. The already good work on game studies will hopefully continue growing and mixing, furthering game design phenomenology and providing a substantial body of work to draw from. And finally, there will be more studies on the epistemic cultures and special nature of knowledge needed and produced in game design. As we have passed the teenage years of the third wave of game studies (Juu, 2001) and digital games have become so common that one can no longer view their existence as a marginal phenomenon, game related research is becoming to be more and more relevant to other fields of inquiry. We will mix with other scholars and keep on bringing our lessons and different research ontologies across the borders. However, this jungle will not become easier to travel and there are more unknown areas to chart. The echoes of the past will continue affecting us and the jungle of the multidiscipline is filled with various interests, opinions, values and ontologies for studying the sphere of games and play. The selection of the methods will be a reflection of this too. Some of them will be useful for you, some you will find ill-fitting, and some will be noise that you have to push through.

BIBLIOGRAPHY

- Aarseth, E., 2001. Computer game studies, year one. *Game Studies* 1(1).
- Banks, J., 2013. *Co-creating Videogames*. Bloomsbury Publishing.
- Björk, S., 2008. Games, gamers, and gaming: Understanding game research. In: *The proceedings of Mindtrek 2008*, October 7–9, 2008, Tampere. ACM.
- Björk, S. and Holopainen, J., 2004. *Patterns in game design*. Charles River Media.
- Blessing, L.T.M. and Chakrabarti, A., 2009. *DRM, a design research methodology*. Springer.
- Bonsiepe, G., 2007. The uneasy relationship between design and design research. In: R. Michel, ed. *Design research now: Essays and selected papers*. Birkhäuser, pp.25–41
- Crookall, D., 2000. Editorial: Thirty years of interdisciplinarity. *Simulation and Gaming*, 31(1), pp.5–12.
- Cross, N. 2007. From a design science to a design discipline: Understanding designerly ways of knowing and thinking. In: R. Michel, ed. *Design research now: Essays and selected papers*. Birkhäuser. pp.41–55
- Deen, M., Cercos, R., Chatman, A., Naseem, A., Bernhaupt, R., Fowler, A., Schouten, B. and Mueller, F., 2014. Game jam: [4 research]. In: *CHI '14 extended abstracts on human factors in computing systems, CHI EA '14*. ACM, pp.25-28.
- Deterding, S., 2016. The Pyrrhic Victory of Game Studies: Assessing the Past, Present, and Future of Interdisciplinary Game Research. *Games and Culture*, online first. DOI= 0.1177/1555412016665067.
- Deterding, S., 2014. The expectable rise, pyrrhic victory, and designerly future of game studies as an interdiscipline. In: *Proceedings of critical evaluation of game studies*. Tampere, University of Tampere.
- Deterding, S., Sicart, M., Nacke, L., O'Hara, K. and Dixon, D., 2011. Gamification: Using game design elements in non-gaming contexts. In: *CHI'11 Extended abstracts on human factors in computing systems*. ACM, pp.2425–2428.
- Dorst, K. and Dijkhuis, J., 1995. Comparing paradigms for describing design activity. *Design Studies*, 16(228), pp.261–274.
- Frayling, C., 1993. Research in art and design. Royal College of Art Research Papers. 1(1), pp.1–5.
- Fowler, A., Khosmood, F. and Arya, A., 2013 The evolution and significance of the Global game jam. In: *Workshop proceedings of the 8th international conference on the Foundations of Digital Games*.
- Fowler, A., Khosmood, F., Arya, A. and Lai, G., 2013. The global game jam for teaching and learning. In: *Proceedings of the 4th annual conference on computing and information technology research and education New Zealand*. Hamilton, New Zealand, 2013, pp.28–34.
- Fullerton, T., Chen, J., Santiago, K. Nelson, E. Diamante, V. and Meyers A., 2006. That Cloud Game: Dreaming (and Doing) Innovative Game Design. Sandbox Symposium 2006. ACM.

Fullerton, T., 2008. *Game Design Workshop, 2nd Edition: A Playcentric Approach to Creating Innovative Games*. Morgan Kaufmann, February 2008.

Global Game Jam, 2015. About. Available at: <<http://globalgamejam.org/about>>.

Hagen, U., 2009. Where do game design ideas come from? Invention and recycling in games developed in Sweden. In: *Proceedings of DiGRA 2009: Breaking new ground: Innovation in games, play, practice and theory*.

Hagen, U., 2012. *Lodestars for player experience: Ideation in videogame design*. Lic. Stockholm University.

Heljakka, K. I., 2016. More than Collectors: Exploring Theorists', Hobbyists' and Everyday Players' Rhetoric in Adult Play With Character Toys. *Games and Culture*. Sage. pp. 1–20.

Hiltunen, K. Latva, S. And Kaleva, J-P. (2017). *The game industry of finland. Report 2016*. Neogames.

Ho, X., Tomitsch, M. and Bednarz, T., 2014. Game design inspiration in global game jam. In: *Proceedings of DiGRA 2014: What is game studies in Australia?*

Holm, I., 2006. *Ideas and beliefs in architecture and industrial design: How attitudes, orientations, and underlying assumptions shape the built environment*. Arkitektur- og designhøgskolen i Oslo.

Huotari, K. and Hamari, J., 2012. Defining gamification: A service marketing perspective. In: *Proceedings of the 16th international academic Mindtrek conference*. ACM, pp.17–22.

Juul, J., 2007. Swap adjacent gems to make sets of three: A history of matching tile games. *Artifact journal*, 1(4), pp. 205–216.

Juul, J., 2005. *Half-real: Video games between real rules and fictional worlds*. The MIT Press.

Juul, J., 2001. The repeatedly lost art of studying games. *Game Studies*, 1(1).

Kerr, A. 2017. *Global Games. Production, Circulation and Policy in the Networked Era*. Taylor & Francis.

Kuittinen, J. and Holopainen, J., 2009. Some notes on the nature of game design. In: *Proceedings of DiGRA 2009*.

Kultima, A., 2015. An autopsy of the global game jam 2012 theme committee discussion: Deciding on Ouroboros. *Proceedings of the 10th international conference on the Foundations of Digital Games (FDG 2015)*, June 22-25, 2015, Pacific Grove, USA.

Kultima, A., 2010. The organic nature of game ideation: Game ideas arise from solitude and mature by bouncing. In: *Proceedings of the international academic conference on the future of game design and technology*.

Kultima, A. 2009. Casual game design values. In: *Proceedings of the 13th international MindTrek conference: Everyday life in the ubiquitous era*. ACM, p. 58–65.

Kultima, A. and Alha, K., 2011. Using the VNA ideation game at global game jam. In: *Proceedings of DiGRA 2011 conference: Think design play*. DiGRA.

- Kultima, A. and Sandovar, A., 2016. Game design values. In: *Proceeding of academic Mindtrek 2016*. New York: ACM.
- Kuutti, K., 2009. Artifacts, activities, and design knowledge. In: S. Poggenpohl and S. Keiichi, eds. *Design integrations: Research and collaboration*. The University of Chicago Press.
- Lawson, B., 2005. *How designers think: The design process demystified*. 4th ed. Architectural Press.
- Lawson, B., 2004. *What designers know*. Architectural Press.
- Lawson, B. and Dorst, K., 2009. *Design expertise*. Taylor & Francis.
- Melcer, E., Truong-Huy D.N., Zhengxing C., Alessandro C., Magy Seif E.-N. and Katherine I., 2015. Games research today: Analyzing the academic landscape 2000–2014. In: *Proceedings of the 10th international conference on the Foundations of Digital Games (FDG 2015)*, June 22–25, 2015, Pacific Grove, CA, USA.
- Musil, J., Schweda, A., Winkler, D. and Biffel, S., 2010. Synthesized essence: What game jams teach about prototyping of new software products. In: *Proceedings of the 32nd ACM/IEEE international conference on software engineering—volume 2, ICSE '10*. ACM, pp.183–186.
- Mäyrä, F. Van Looy, J. and Quandt, T., 2013. Disciplinary identity of game scholars: An outline. In: *Proceedings of DiGRA 2013: DeFragging game studies*. DiGRA.
- Mäyrä, F., 2009. Getting into the game: Doing multi-disciplinary game studies. In: B. Perron and M.J.P. Wolf, eds. *The video game theory reader 2*. Routledge, pp.313–329.
- Mäyrä, F., 2008. *An introduction to game studies: Games in culture*. SAGE.
- Numinous Games, 2016. *That Dragon, Cancer* [game]. Numinous Games.
- O'Donnell, C., 2014. *Developer's dilemma: The secret world of videogame creators*. The MIT Press.
- Peltoniemi, M., 2009. *Industry Life-Cycle Theory in the Cultural Domain: Dynamics of the Games Industry*. PhD. Tampere University of Technology.
- Preston, J., Chastine, J., O'Donnell, C., Tseng, T. and MacIntyre, B., 2012. Game jams: Community, motivations, and learning among jammers. *International Journal of Games-Based Learning*, 3(2).
- Reng, L., Schoenau-Fog, H. and Kofoed, L.B., 2013. The motivational power of game communities-engaged through game jamming. In: *Proceedings of the 8th international conference on the Foundations of Digital Games*.
- Salen, K. and Zimmerman, E., 2003. *Rules of play: Game design fundamentals*. The MIT Press.
- Sandovar, A., 2015. Cultural narratives in game design. In: *Doctoral consortium of FDG 2015*.
- Schell, J., 2008. *The art of game design: A book of lenses*. CRC Press.
- Sato, K., 2009. Perspectives on design research. In: S. Poggenpohl and S. Keiichi, eds. *Design integrations: Research and collaboration*. The University of Chicago Press, p.25–49.

Schön, D.A., 1983. *The reflective practitioner*. Harper Collins.

Scott, M.J. and Ghinea, G., 2013. Promoting game accessibility: Experiencing and induction on inclusive design practice at the global games jam. In: *The inaugural workshop on the global game jam (GGJ'13) at FDG 14*.

Simon, H.A., 1992. *The sciences of the artificial*. MIT Press.

Tschang, F.T., 2003. Beyond normal products and development processes: Computer games as interactive experiential goods and their manner of development: What do we know about innovation? In: *Conference in honour of Keith Pavitt*. University of Sussex, 13–15 November, 2003.

Turner, J., Thomas, L. and Owen, C., 2013 Living the indie life: Mapping creative teams in a 48 hour game jam and playing with data. In: *Proceedings of the 9th Australasian conference on interactive entertainment: Matters of life and death, IE '13*. ACM.

Stenros, J. and Kultima, A., forthcoming. On the expanding ludosphere. *Simulation & Gaming*.

Waern, A. and Zagal, J., 2013. Introduction. *ToDiGRA*, 1(1).

Walker, J.A., 1989. *Design history and the history of design*. Pluto Press.

Wilson, D. and Sicart, M., 2010. Now it's personal: On abusive game design. *Future Play 2010*.

Yamane, S.R., 2013. Adaptability of the global game jam: A case study in Japan. In: *The inaugural workshop on the global game jam (GGJ'13) at FDG 14*.

Zimmerman, E., 2012. Jerked around by the magic circle: Clearing the air ten years later. *Gamasutra.com*.

Quinn, Z. 2013. *Depression Quest* [game]. Zoë Quinn.

Zook, A. and Riedl, M.O., 2013. Game conceptualization and development processes in the global game jam. In: *The inaugural workshop on the global game jam (GGJ'13) at FDG 14*.

CHAPTER 3

DE-CODING GAMES THROUGH HISTORICAL RESEARCH IN ART AND DESIGN

CHRISTOPHER W. TOTTEN

Games provide many challenges for researchers interested in understanding them as a field of aesthetic design or as designed cultural artifacts such as those from the visual arts, architecture, graphic design, or crafts. Digital games, those that are played through a computer or television console, have existed for just over forty years (Donovan, 2010) and much of their designs are a response to technological limitations or consumer trends. In casual interactions, many game developers have observed, this leads to the mistaken notion that all game makers and researchers are skilled coders rather than possessing other competencies in art or aesthetic design (Rogers 2010). Even non-digital games; tabletop, board, sports, and others played without electronic devices; have primarily been mentioned in the context of non-design research.

Alternatively, the first serious investigations of games and play was Huizinga's *Homo ludens* (Huizinga, 1955), which focused on games not for the elements of their design, but as they related to other fields—sociology, history, and cultural studies. These threads would be followed by other researchers such as Sutton-Smith (1997) and Caillois (2001) and their sociological investigations of play. These trends set the precedent for games to represent social codes, conventions, and frameworks and their interactions in the world.

Among game developers, *design* writing primarily explores practical elements of game creation, but leaves out the theoretical, philosophical, and aesthetic elements of design. Books such as Adams' (2009) *Fundamentals of game design* and Bates' (2004) *Game design* lack the investigations of design's influence exemplified through Lyndon and Moore (1996) celebrating memorable architectural works or Norman (2005) describing how design enriches the lives of users.

As technological pieces, sociological indicators, and managed entertainment products, games have little of the kind of critical design rhetoric that other older fields enjoy. However, game design researchers such as Salen and Zimmerman (2003), Bogost (2007), and Flanagan (2009) are writing deep discussions of the aesthetics of game design and gameplay that fill in game design's historical gaps with design studies from other fields: art, architecture, graphic design, and others. These studies include historical surveys of the knowledge base of design fields and comparative analyses of games and famous works of design.

Like established design fields such as architecture, games research can benefit greatly from researching historical examples of good design and contextualizing these examples according to

cultural trends. This chapter outlines research methods used by game design scholars for analyzing games through *historic design* precedents from fields of art and aesthetic design. It explores historic factors of the game industry that led to game development's inward-facing foci on technology and business trends as well as game design research's focus on cultural aspects of games and play rather than design. With these trends in mind, the chapter describes design research methods from other fields adopted by game researchers for breaking (de-coding) the molds of technology, business, and sociology to establish game design's aesthetic design identity. Lastly, the chapter suggests how these explorations can be utilized by researchers, students, instructors, and developers to treat historic design examples as precedents for game analysis and production.

CHALLENGES TO RESEARCHING GAMES AS DESIGN

In their book *Rules of play*, Salen and Zimmerman (2003, p.41) offer the following definition of design distilled from several historic definitions: "Design is the process by which a *designer* creates a *context* to be encountered by a *participant*, from which *meaning* emerges." This definition is a useful one, as it describes the strata of actors affecting and affected by a work of design—the designer and the product they create and the participant and their experience with the product. Whether an advertisement created by a graphic designer, a building created by an architect, a golf course devised by a landscape architect, or an interactive piece conceived by a game designer, Salen and Zimmerman's definition exposes design's identity as a process of *problem solving*.

Indeed, designers consider design a process of answering questions through the implementation of thoughtfully executed products. In the case of larger design projects, such as a building or a game, this process may involve the work of professionals with many different skill sets. Indeed, many in classical design fields such as architecture argue that design is the result of many fields coming together to form a cohesive vision. Segal (2006) refers to "design professionals", a term encompassing architects, engineers, lighting and acoustic designers, and many others, in his descriptions of the different parties involved in the construction process. These design professionals, Segal states, are "all the people who produce (by art, design, invention, experience, and research) the information from which buildings are created." (p.23) The architect, he argues, coordinates the work of the other designers into a set of drawings. Similarly, game designer Adriaan Jansen (2012) lists among the roles of a game designer "pitching and communicating" which he argues encompasses team organization and coordinating the input of team members.

For games, this includes game designers themselves, as well as artists, audio designers, composers, programmers, and others who contribute to the finished game in designing the aesthetics of the game. In practice, however, these disciplines are not often viewed as having making equal contributions to a game. Development-focused game research, which actively creates games rather than studies them, enforces a more hierarchical system: designers are considered by many as architects of games. Other team members, especially those trained in aesthetic fields of visual and audio art and design, act as contractors building the game's components as general contractors would build a house. This attitude creates challenges for developing new avenues for understanding games through these "contractor" roles; their own design fields with histories spanning generations (art, music composition, computer science, and others) being relegated to mere utility.

This section describes several game production types common in contemporary game-based research, their goals, and how their structures differ from research that views games as a field of not only interaction design, but of aesthetic design as well. This exploration describes the roles that games

play in each type of research and the opportunities these projects do or do not provide for research in various aspects of game design—visual art, gameplay design, computer science, and others. This section will similarly survey selected game histories and compare the approach they use to describe and order games—technological, cultural, artistic, or otherwise—to understand how they support or challenge the ability to contextualize games in the canon of art and design.

CHALLENGES IN SERIOUS GAMES RESEARCH

At the time of this writing, game research represents a diverse set of disciplines that utilize games as a catalyst for exploring equally diverse sets of ideas. As many authors write about game design though, very few offer critical discourses of the components of games as designed objects. Games are often viewed through lenses that suggest that the game itself is a single designed object created by a game designer instead of a system of designed objects, produced by a collection of design professionals, working together to create an experience for the player. One area where this attitude is particularly prevalent is in research that views games as effectors of the world around the game itself in psychology, education, sociology, medical, and other contexts, especially in serious or applied games. These games are defined by Djaouti, Alvarez and Jessel (2011) as “Games that do not have entertainment, enjoyment or fun as their primary purpose.” This section presents challenges based both on serious games research’s overwhelming prevalence in the field of game research and the aspects of game development that it favors over concerns of art and aesthetic design. Serious games does not represent just one sector of game research, they represent a significant force at the time of this writing. A survey of the Digital Game Research Association (DiGRA) online library—a collection of papers from the DiGRA conference proceedings, white papers, and other works from 2002 onward—shows the dominance of serious games and related topics in game research. For example, the list of keywords used in the database shows that the largest used single keyword behind “game design” (92 uses) and “video games” (30 uses) is “serious games” (25 uses). These are followed closely by “learning” (23 uses.) Likewise, there are large variations of keywords about topics such as “advergaming” (games used as advertising: 5 different keywords), behavior and behavior modification (7 different keywords), cognition (8 different keywords), gender (10 different keywords), and social science-related topics in games (42 different keywords).¹ While “game design” itself is a regularly-used term, it is primarily used in papers that discuss trends associated with the creation or analysis of game interactivity mechanics rather than asset creation processes undertaken by design professionals (art, sound, music, etc.) to build the aesthetics of games. Compare this to art and aesthetic design-centric topics like level design (4 uses, 2 different keywords), sound design (4 uses, 3 keywords), game art (8 uses, 2 different keywords), or music (1 use, 1 keyword) and a preference towards serious games, social science research, and game interactivity becomes clear (DiGRA, n.d.)

Many evaluations of serious, persuasive, or applied games in both academic and popular circles put the relationships between game mechanics and the user’s play far above other factors such as the effect designed components may have on the user’s experience with the game (cf. Swain, 2007; McGonigal, 2011). In *Reality is Broken*, for example, McGonigal (2011) presents both a collaborative effort by the *Halo 3* (Bungie, 2007) online community to kill a combined one billion in-game enemy aliens and her own smaller-scaled game projects designed explicitly for social change. Though the scopes of these games vary greatly—*Halo 3* (Bungie, 2007) is a graphically sophisticated game created by a large studio for the Xbox 360 game console while McGonigal’s games are developed by a few people and

1. Other large topic areas include variations on narrative or narratology (12 different keywords), ludic or ludology (10 different keywords), and general uses of games, game design, pervasive games or topics about play.

can be played either without technology or through comparatively simple web applications—they are discussed with the same mechanics-first rhetoric. While McGonigal describes the *effect* that the assets produced by design professionals on the team have on players—emotions such as awe related to the game’s music and visual art, community related to the written narrative—little is discussed of the qualities of these assets that produce these emotional effects or how they may have been created.

Experiences in developing serious games show that while they offer educational opportunities for students and the possibility of lucrative client work for university game programs and studios, their structures favor the “single designed object” view of games apparent in previous examples. From McGonigal’s (2011) discussions in *Reality is Broken*, one can see that games used for real-world change can feature anything from virtually no assets beyond the game mechanics themselves to cutting-edge graphics, sound, and social online features. It can safely be stated, then, that the primary goal of these games is the execution of a game’s gameplay mechanics and does not ask any significant questions about the creation or use of assets created by design professionals beyond the gameplay designer themselves. Examples from universities such as George Mason University near Washington, DC are typical of serious and persuasive game projects: a client or researcher with a social change-oriented goal approaches a university game studio with a set of experiential or rhetorical goals in mind, such as education about a topic or modification of behavior. These exercises become primarily focused on creating a set of mechanics that embody the social change goal. (Totten, 2013.)

Challenges to viewing games within the context of art and design history in the serious games field comes from these downplays of the aesthetic aspects of games in favor of interactions and player activity. Using the cited examples from George Mason University once again, aesthetics or audio in the exercise were presentational factors rather than themselves being vital components of the research. In one example, the only significant concerns over visual or audio components was one where the subject of the art assets were felt to illustrate the wrong idea—the students had created a game where liver cells fought off alcohol molecules for an anti-drinking game, implying that the person had already imbibed. This was fixed by replacing the pictures used in the game, though. While the images presented were an important aspect of the social change message of the game, no considerations were given for the historical precedents or generative methods of the art assets themselves.

On a broader scale, these examples show how trends in game research enforce the hierarchical role of professionals on academic game development teams. As trends continue to favor holistic views of games as experiences driven by mechanics rather than views of games as systems of creative works by multiple authors, aesthetic elements of games will continue to be relegated to utilities rather than a significant element of games research. While one may argue that serious game projects simply do not concern themselves with art and aesthetic design research and that other projects may be undertaken to focus on them, some within serious games research argue that aesthetic features of games such as visual art and sound have little to no impact on the quality of the product (Grace, et al., 2015). Pairing arguments such as this with trends such as those shown previously in analysis of the DiGRA digital library and through experiences in serious game projects (Totten, 2013) illustrate that opportunities highlighting the arts in serious game research exist in a discouraging minority.

TECHNOLOGY-BASED APPROACHES TO GAME HISTORY

The previous section described how serious games research focuses on the effects of game mechanics, causing tension with research focused on building the game itself. The generative aspects of game



Figure 1. This image of the persuasive game, *Ice Bucket Challenge*, is typical of many games created for social, educational, or persuasive purposes. The message (de-emphasizing the social trend of pouring ice water on oneself to instead donate money as a means of supporting medical research) is of primary importance and art and aesthetic factors are secondary, often merely using popular styles (in this case NES-style pixel art) rather than providing opportunities for design professionals to experiment with new styles or production techniques.

development are of serious consideration to research disciplines rooted in technology though, especially those spawned from computer science or engineering. However, these create their own challenges to contextualizing games in fields of art and aesthetic design history. As Donovan (2010) points out, the evolution of games is often chained to the evolution of computer technology, often at the expense of non-technological sources of inspiration for game works or criticism. Indeed, many game histories are tracked through the development of various consoles or computers rather than through art and design trends. The audiovisual aesthetics of games, likewise, are seen as a product of hardware limitations rather than of any specific aesthetic trends. These computer-dictated aesthetics, such as pixel art or low-poly 3D art, have since become aesthetic trends in games, highlighting games' primarily technology-derived history. This section surveys several published histories of the videogame medium to demonstrate the amounts that technological factors or art and design factors influence historical categorizations of games.

In his introduction to *Replay: The history of video games*, Tristan Donovan (2010) recalls an interview with Sega of America executive Michael Katz in which he is asked why he is writing “another book on the history of videogames.” (p.xiii) Donovan gives the following reasons: to document the game industry history of non-US countries and to focus on the artistic elements of games rather than the technological aspects of computer hardware. Articles and videos on popular gaming news websites such as IGN, GameTrailers, and Kotaku follow this pattern—tracking the history of the medium and specific franchises via their entries on specific consoles. Likewise, Kent’s (2001) *Ultimate history of video games: From Pong to Pokemon and beyond*, one of the first books to document the history of the medium, traces games according to technological and business factors that led to the creation of many popular games. Beginning with the development of early Bagatelle and pinball tables, Kent presents a chronological history of the medium marked by business milestones—such as Atari’s purchase by Warner Communications and the establishment of the industry’s ratings system—and the release of game consoles from prototypes and early experiments in the 1950s to the Magnavox Odyssey, Atari, Nintendo Entertainment System, and their successors.

The Smithsonian American Art Museum’s *Art of video games* exhibition (Melissinos, 2012), likewise follows chronological and technological tracks: dividing games into five eras, *start!* (1970s–early 80s), *8-bit* (1983–1989), *bit wars!* (1989–1994), *transition* (1995–2002), and *next generation* (2003–today). Likewise, each era features several popular consoles and computers and a selection of games for each that represent four common game types: target, adventure, action, and tactics. From personal observation, the exhibit evoked fond memories and delight from visitors, many of whom saw it several times during its initial run. Likewise, much of the mainstream press during the exhibition’s initial run was positive. (Kohler, 2012; Mendelez, 2016) However, commenters closer to the game world were not as kind, calling the exhibit sanitized (Rough, 2014) and “focusing too much on mainstream commercial video games and stressing too often the evolution toward realism.”² (Schwendener, 2014) Sharp (2015) even notes the “liberal use of the ‘A’ word” (meaning art) and notes that the term is used to describe everything from the game’s visual aesthetics, to the craft of game making, and to lend weight to the argument that games are important.³ These reactions bring the challenge of the challenges of technological views of game history to the fore, exposing the missing elements of aesthetic and design thinking behind the medium.

Even Donovan’s own efforts cannot escape the specter of technology looming over the history of the videogame medium. While Kent’s book begins with Bagatelle and Pinball, demonstrating the genesis of arcade-style play, Donovan’s begins with the dropping of the atomic bomb in 1945 and subsequent advances in computers throughout the following decades. Games, as shown by Donovan, were an advantageous medium through which to demonstrate or prototype new technologies on early computers with easy-to-understand models that the lay person could enjoy. John Bennett, for example, designed a computer (NIMROD) to play the game *Nim* as a technological showcase piece for the 1951 Festival of Britain. Likewise, William Higenbotham (1958) created *Tennis for two* to entertain guests for Brookhaven National Laboratory’s annual open-house. As computers became more sophisticated, computer scientists used increasingly more complex games, such as chess, to advance fields such as Artificial Intelligence⁴. Later pushes towards videogames as we now know them

2. Some of this commentary and review material for *The art of video games* comes from its touring engagements after the initial exhibition in DC.

3. This is not to suggest that *The art of video games* was a bad exhibit, I rather enjoyed it. Full disclosure: I am a friend of the exhibit’s curator and have myself worked on multiple game events with the Smithsonian American Art Museum.

4. Alan Turing is notable for creating a chess algorithm in 1952 that could not be executed on computers at the time, so he played a colleague acting as the computer himself and made moves according to the program.

involve prototypes for interactive television games, such as Ralph Baer's (1967–68) Brown Box, and the use of university computers to create entertainment programs (*Spacewar!* at MIT)

While it could be argued that the technological bias is natural runoff of the technological race between the United States and the Soviet Union during the Cold War, using this history as the foundation for understanding the games medium has detrimental effects on understanding games as art and design similar to that created by serious games. Foundations of Digital Games (FDG), a conference with proceedings listed among the Association for Computing Machinery (ACM) digital library, lists among its most utilized topic areas “algorithmic game theory and mechanism design”, “human computer interaction”, “information science education”, and “human centered computing.” (ACM, n.d.) Like serious games, the prominence of computing technology-based game research shapes the outlook on games developed as part of this research and the roles that stakeholders have on development teams.

Unlike serious games, games developed as technology research are primarily hardware or software prototypes for the development of larger computing fields such as artificial intelligence. The lead roles on such teams are taken by computer scientists, who act as both technical lead (the team member in charge of organizing programmers and making decisions on technology for the team to use, etc.) and lead designer (enforcing the creative vision for the game). Like serious games, this puts art and aesthetic design professionals into a secondary role hierarchically. Rather than a holistic mechanics-first view of games, these games employ a holistic technology-first view, where the games are software products first but do not act as a system of designed objects representing the work of multiple design professionals.

In industry, the technology-first view of games and game aesthetics creates a utilitarian attitude towards game art and audio similar to that held by the serious games set, but one much more based on technology. *Game art*, for example, is a field that at times feels more associated with computer graphics than fine visual arts. Talks at the 2016 *Game developers conference* (GDC) in the *visual arts* track, for example, have titles such as *HDR rendering in lumberyard*⁵, *Shaders 101: Foundational shader concepts for technical artists*, and *Photogrammetry and Star wars: Battlefield*. (GDC + VRDC, 2016) Of the seventy-seven scheduled sessions at GDC 2016 in the visual arts track, only eight cite techniques or concepts explicitly derived from the fine arts or aesthetic design fields. This likewise trickles down to game development schools, where tracks in game art emphasize software courses over fine art topics.

Attitudes from dominant areas of game research—serious games and technology—have created patterns that challenge researchers hoping to work with games within the context of art and aesthetic design history or as the resultant works of multiple design professionals. The lack of games research within these contexts, alternatively, creates enormous opportunities for opening new areas of research. The next section explores areas where trends and historical methods from aesthetic design fields may be used to find new ways to view games.

HISTORICAL DESIGN RESEARCH METHODS FOR GAMES

While *game design* can be understood as a field of design according to Salen and Zimmerman's definition, this chapter has thus far focused on the ways that game design has been separated from the arts and more classical design fields in both history and practice. As we have seen, patterns in historical understandings of games create challenges for utilizing knowledge from aesthetic design

5. A game engine created by Amazon.

fields in games research: games are either evaluated as effectors of societal conditions or as pieces of technology. In this book's introduction, however, Lankoski and Holopainen acknowledge the work of researchers who bring knowledge from other aesthetic design fields into the discussion of game design. Their citations, Sheldon's (2004) use of dramatic writing in games and Totten's (2014) use of architecture as a precedent for level design come a decade apart, indicative of the previously discussed minority of this type of discourse in game research. Even similar works, such as Howard's (2008; 2014) use of medieval literature as the basis of quest design or occult magic as the basis for magic systems are the work of a limited number of authors, in this case one author, rather than widespread throughout games research.

This section describes alternative approaches that contextualize games within the canon of art and aesthetic design history. It evaluates the effectiveness of each for providing an a view of games that treats the creative works within games—art, music, sound, etc.—as meaningful works themselves. As writers such as Ernest Adams (2002) indicate, classical fields of design like architecture have much to offer in both practical and theoretical approaches to game study and development and in acknowledging the contributions of multiple parts of an overall game towards the game's experience. Understanding the development and patterns of art and design history may offer answers to contemporary questions in the field or ideas for design researchers looking to subvert game industry norms. This section will also demonstrate practical techniques from architectural precedent study, which is of immediate use to game researchers, to serve as an example of how such techniques may be used in game research. The examples and techniques in this section will hopefully inspire other researchers to make similar connections with the historical theories and techniques from other fields.

DESIGN-HISTORY APPROACHES TO GAME DESIGN

In the previous section, tech-centric game histories were explored, showing how even in self-declared non-tech approaches to game history, the specter of technology is intrinsically linked to the games medium. Schwendener's (2014) criticism of *The art of video games* summarizes this technological history as an evolution towards realism. While this statement is a factual one about the goals of computer graphics development, it is also notable for using art history terminology to analyze a traditionally technological field.

In art history, realism describes two phenomena. The first is the pursuit of a realistic-as-possible depiction of a subject—criticised by Ruckstuhl (1917) as “nothing but technical copying”—which closely mirrors Schwendener's (2014) summarization of the history of computer graphics. Realism may also describe a subsersive movement that depicted the lives of regular people through painting techniques usually reserved for epic historical or mythological scenes. (Duro, 2007; Ormiston, 2014.) Applied to games, one definition of realism resembles the increasing photorealism of computer graphics while the other could be applied to games like *Cart life* (Hofmeier, 2011) or *That dragon, cancer* (Green and Green, 2014), which use the videogame medium to depict everyday people. Schwendener (2014) may not have been trying to explore this dichotomy of realism and how it applies to games, but his use of such a term establishes a precedent for using art-relevant terminology to describe a field typically discussed as technology.

THEORETICAL HISTORY APPROACHES

While Donovan (2010) makes heavy use of technological history in his own book on videogame history, he breaks the trend when approaching markets not typically explored in game

histories—British, French, Spanish, and other European game industries. While his tellings of the American and Japanese industries follow the developments of specific technologies or the founding of studios, his telling of European game history appears more like a social or artistic history of game development. He coins the term “British Surrealism” to describe the colorful and goofy games by Monty Python watching independent programmers on the ZX Spectrum computer in the early 1980s. Likewise, he terms the narrative-rich and socially-minded games of developers influenced by the 1968 student occupation protests, *French touch*.

While Donovan defines the game history of previously-underserved regions in art history style, Juul (2014) likewise approaches the history of visual styles in the *Independent games festival* (IGF) in terms of historic art styles. In this case, Juul likens pixel art, defined by Silber (2015) as digital art in which each pixel is placed purposefully, to the arts and crafts movement of the nineteenth century. Juul argues that pixel artists seek a generative method more authentic to the origins of computer graphics similar to how Arts and Crafts artists created crafted books and other objects with pre-industrial methods. While an industry event, the digital distribution through markets like Steam or Xbox Live (Pajot and Swirsky, 2012), marks one of the early shifts in style for indie games, Juul tracks the rest as one would art movements. Both Donovan and Juul’s works take previously underdocumented game histories (European game history and the indie scene) and find opportunities for new models of historic categorization.

Donovan and Juul’s connecting of trends in the game industry to movements in art history offer alternatives to traditional tech-oriented historical understandings of games. As established earlier in the chapter, technological views of games and the game industry influence roles on research and development teams away from design professionals and towards tech-focused contributors. Donovan and Juul’s art movement examples provide important precedents for analyzing games as art works in the context of art and aesthetic design history that may influence further efforts in this area.

PRACTICAL HISTORY APPROACHES

While Donovan (2010) and Juul’s (2014) histories offer examples of organizing games as products of art movements for historical categorization, other writers offer histories with the purpose of informing practical art-related efforts. Sharp presents a typology of games and game-like works organized according to the affordances of contemporary art for the purpose of discussing ways that games may become parts of curated exhibitions and collections. He coins the terms

- *game art* describing artworks that utilize the tools or subject matter of videogames to create cultural pieces
- *artgames*: games that explore subject matter similar to other areas of high art such as film or poetry,
- *artists games*: games that strive for both fulfilling playability and explorations of high subject matter (2015).

Like Juul, Sharp (2015) compares and contrasts games according to their artistic similarities rather than their technological ones and presents a brief timeline of works that fit his descriptions. Rather than historical categorization, however, he applies his framework to delineate games or game-like artworks that should be considered art from purely entertainment products and suggest perspectives for including them in exhibitions.

Like Donovan, however, Sharp primarily views games as holistic objects rather than a collection of artistic efforts. For example, among the properties of games utilized in creating Artgames are, “interactivity, player goals, and obstacles providing challenge to the player—to create revealing and reflective play experiences.” (Sharp, 2015, p.12) Nowhere in his summation of game elements are the visual assets, music, sound effects, or other works of other design professionals derived from art and aesthetic design that equally affect players. In a practical sense, this risks limiting the criteria with which games or the artworks that combine to create games may be considered for inclusion in museum exhibitions. While understanding games according to the affordances of contemporary art strengthens the medium’s cultural presence, the argument that mechanics primarily create experience presents similar difficulties to those found in serious games. It also ignores an opportunity to explore the role that designed symbolic visual assets have in affecting player behavior the same way that visual elements in art communicate to a viewer. (Totten, 2014, p.170)

Two other histories from *Contemporary research on intertextuality in video games* (Duret and Pons, 2016) and *An architectural approach to level design* (Totten, 2014) similarly seek to connect games to the art and aesthetic design world in practical ways. They do so by finding new art production methods for games and by finding new criteria for analyzing and building game levels (Totten, 2014; 2016). The art history comparison from *Intertextuality in video games* describes trends in the growth of art styles in the nineteenth century and likens them to the development of dominant visual styles within the game industry. The previously discussed development of realistic graphics in big-studio games is compared to the enforcement of visual realism in French art academies. Likewise, artworks that broke those trends and eventually led to explorations in style and perspective are compared to game projects that accomplish similar goals either through subject matter or how the game itself is built, such as using real-world materials for making art assets in games like *Ever yours, Vincent*. (Orlati, 2014.)

The architectural history comparison from *An architectural approach to level design* (Totten, 2014) occurs in two sections: one detailing architectural history highlighting factors related to how spaces are experienced and another detailing the history of spatial types found in games. As Maguid and Ansari (2016) point out, game architecture rarely has to respond to real-world factors such as physics or zoning codes. In games, spaces are primarily experiential: they are used to set the stage for game events or guide players via visual cues. As such, analyzing historical architecture according to their ability to provide the types of experiences valued in game levels is useful for finding precedents for game space design in real world architecture. Likewise, addressing the history of gamespaces and highlighting the types of experiences possible with each development in game technology is useful for reconciling the technological history of games and computer graphics with the experiential factors of game levels.

These histories take into account the work of design professionals who contribute to overall game experiences—specifically artists and level designers. However, they show two very different ways to compare the history and knowledge of other fields with that of games. The art history comparison directly contrasts the historical events with game industry trends in the same body of text, while the architectural history does so much more abstractly: putting games and architectural works in two entirely different sections. While the architecture is compared to spatial factors important to games (as the text highlights using an example of Gothic-like architecture from *Halo 4* [Bungie, 2012]), it puts the onus of finding one-to-one connections on the reader. The design history presented in *An architectural approach to level design*, therefore, is more confusing because the architectural design timeline and the game design timeline it presents are in different sections. Such an approach works only when there is additional content (in the case of *An architectural approach to level design*, the rest

of the book) to provide additional descriptions of how the history of games and the history of the other medium intersect. Future or self-contained histories of games where they are compared to other mediums would benefit from more direct connections between the games themselves and works in the compared medium. The art history, on the other hand, because of its more direct approach, can lead into other material, in this case practical techniques to be adopted by game developers to bring new artists to game development or add to their art creation pipelines.

While this section described practical histories and how they propose useful methods for game research derived from art and aesthetic design, the rest of this chapter will describe these methods in detail and demonstrate their usefulness through their application in research projects. This next section outlines one such method directly related to design histories for games: precedent studies, and describes how sketching practices used by architects can be used to record observations about design precedents, approach games as works by multiple design professionals, and incorporate art and aesthetic design history into game works.

PRECEDENT STUDIES IN GAME PRODUCTION

The Bauhaus design school of the early twentieth century in Germany is famous for many things, but one of their most influential contributions to the field of design may be its *Vorkurs* (preliminary course), in which students explored contrast, color, texture, form, rhythm, and other notions through practical exercises. Students would then consider the “sensual, intellectual, and spiritual meanings that might emerge” from combining and juxtaposing these design elements. Under Lazlo Maholy-Nagy and Josef Albers, the course took on an increasingly practical approach and had students studying the properties of materials, compositional balance, lighting, and eventually architecture that would influence projects in other studio courses. (Lerner, 2005) Even after the closure of the Bauhaus in 1933, the *Vorkurs* became the foundation for many other introductory courses in art and design throughout the world. These courses, like the *Vorkurs*, emphasize students clearing pre-conceptions of design from their minds and experimenting with aforementioned elements of design through critique and small projects. (Lerner, 2005, p.218) It is in these classes that *design language* is introduced to students through readings such as Lyndon and Moore’s (1996) meditations on architecture and in-class critiques of existing works.

For games, many of these methods can be valuable in both education and industry frameworks. Teaching developers about aesthetics and design language would be difficult, however, given the great range of topics already in game design education (Gold, 2008) or the overwhelming demands of studio work. Until a full effort developing such a framework is undertaken, existing practices can benefit from the methods for precedent study utilized in the *Vorkurs* and courses influenced by it. The previously discussed histories, for example, were not just listings of games that had been released, but curated selections of games that answered the writers’ questions about games and game design: what are the games that best showcased the history of gaming tech? what games showcase regional sensibilities about design? which games best fit the affordances of contemporary art? and which industry trends match trends found in art history?

Beyond establishing that a game or series of games may be a precedent, the next step is unclear: what should be done with this knowledge? How should we play these games? How do we carry the knowledge gained from playing these games, if any, away with us to use in our own work? How do these methods differentiate the work of individual design professionals from the whole game? These

questions are answered by the design research method that this section will provide an overview of: sketching and diagramming precedent studies.

Ching and Juroszek (1998) explain that drawing both “invigorates seeing” and “stimulates the imagination.” Indie game developer Alex Johansson (2015) also illuminates that drawing in a sketchbook is useful as a “back up for the brain”, and because many of his game ideas come from observing life around him. For those unfamiliar with sketching and diagramming, it should be noted that it is not done to create aesthetically pleasing artworks (though sketches can certainly fulfill that function), but rather as a method for recording ideas or documenting the relationships between objects in space (Totten, 2014, p.49).

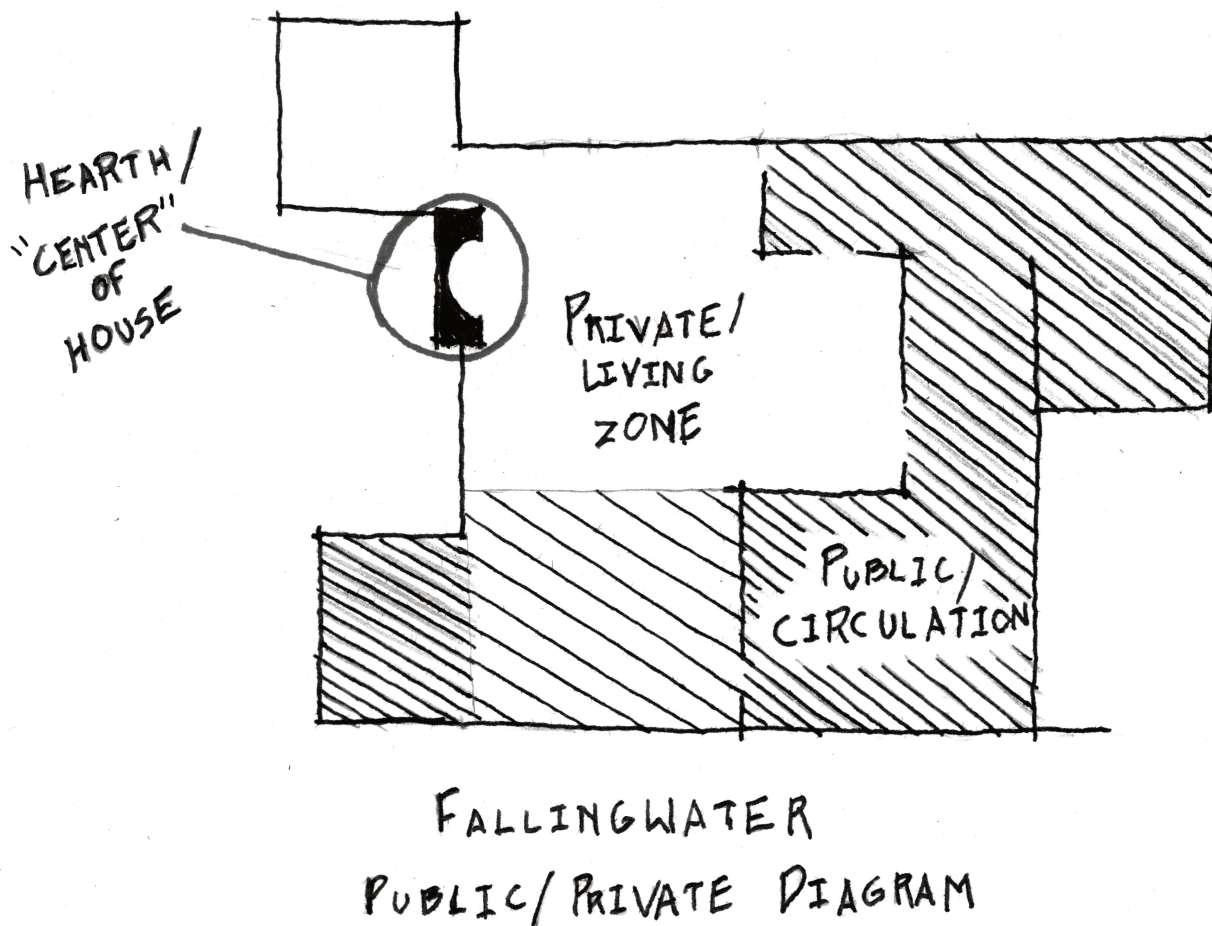

Figure 2. This diagram of Frank Lloyd Wright’s Fallingwater does not show specifics of its construction or try to be aesthetically pleasing, but instead communicates ideas about the building, in this case the amount of privacy occupants have in each major space of the house’s main floor. (This image was originally published in Totten (2014) An architectural approach to level design.)

OBSERVATION AND MATERIAL COLLECTION

Sketching allows designers to directly gain information from historical precedents for the benefit of their own work by isolating important ideas and elements from the designed whole. For example, a level designer may want to understand how their level geometry teaches the use of new tools, so they

decide to play a game that features this sort of construction, like *Super metroid*. (Nintendo, 1994) While game developers utilize sketching for rapid prototyping of user experiences (cf. Buxton, 2010) artists and visual designers utilize sketching for recording observations and visually representing abstract ideas about their work. For artworks or works of aesthetic design, observers use sketchbooks to create the types of diagrammatic sketches like the one shown in figure 2. This is based on observation of the work, conditions of the work itself or around the work, and, occasionally like Buxton's techniques, how others interact with it. For games, such observation might occur when the researcher is playing a game themselves or when others are playing the game in front of them, as is common in the industry practice of playtesting, where developers watch players to ensure that their game is clear and that the intended experience is achieved.

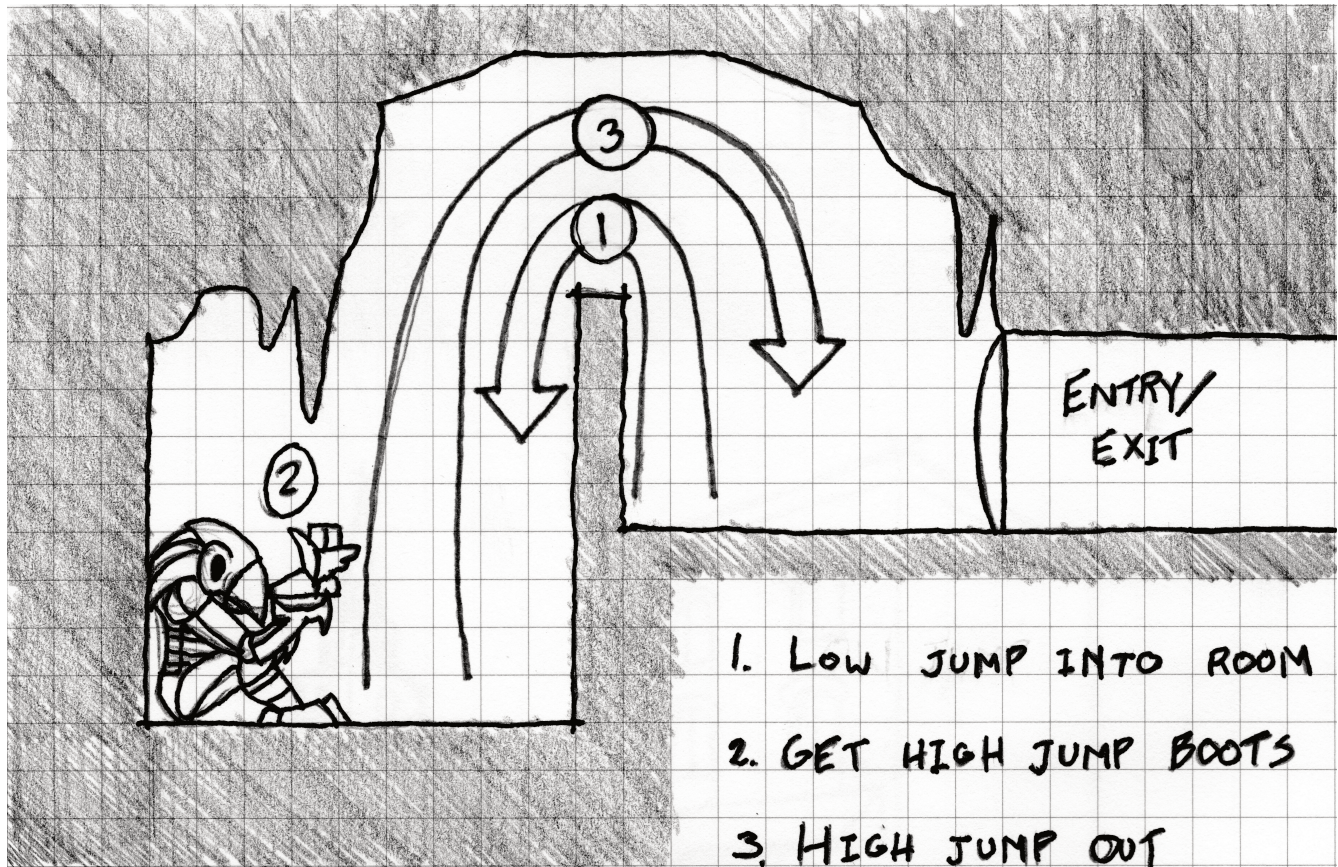

Figure 3. This sketch shows an example of a moment of gameplay diagrammed by a researcher studying the teaching mechanisms in *Super Metroid*'s level design. (This image was originally published in Totten (2014) An architectural approach to level design.)

While many games are not intended to accommodate a player stopping to sketch precedent elements (imagine asking an enemy mob to stop their attack so the architectural details of an arena may be recorded), taking photos, screenshots, or recording video via software such as Fraps helps researchers archive game moments at the time for more peaceful sketching later. While this diminishes some of the spontaneity that sketching for other media has, it allows researchers to progress through games. Supplementary tools like adding to a journal of gameplay experiences after each session may help keep the elements that researchers want to sketch fresh in their minds and produce sketches of specific moments of gameplay later, like the one our theoretical *Super Metroid* player recorded from a screenshot in figure 3.

HOW TO DIAGRAM

As stated previously, diagramming is not the same as producing drawings for aesthetic pleasure. Instead, it is the recording of intangible elements of a design such as progressions of experiential values (privacy, lighting, etc.), movement patterns, or formal elements in the most easily understood fashion. Diagramming is not the place to record exact details of how objects look or record how they are assembled.⁶ Instead, diagrams emphasize one or two important elements each rather than try to capture every element of a work. For game researchers, diagramming is a useful tool for documenting individual game elements.

Figure 3 shows one way that a game may be diagrammed. This diagrammatic sketch was done to record level design values, so most aesthetic detail of environment art is left out. Only the level elements that are important to the interaction being analyzed (players entering a room and only being able to exit once a high-jump item has been collected) are drawn with any detail. While the outline of the architecture of the room is shown, the walls are blackened out—a technique called *poche*—because their visual qualities are unimportant to the diagram and would distract from its purpose. Likewise, arrows are used to describe how the player moves through the space. Text is used in this example, but may be excluded depending on how the researcher wishes to draw their own diagrams.

Similarly, figure 2 portrays one idea—the level of privacy in different spaces—and utilizes different levels of *hatching* to convey the gradations from one extreme (total privacy in the living room) to the other (very little privacy in the entry area and terraces). Hatching is the use of lines to shade a drawing, with tighter groupings of lines creating darker tones. Hatching produced for diagramming tends to be drawn in a very exact fashion and is less for tone and more to delineate value of an abstract element of the design or can, like *poche*, show solid masses. In this diagram in particular, details of the actual floorplan of the building is secondary and merely hinted at via the hatching values, as the artist chose to portray room delineation via changes in privacy. In games, a researcher may use hatching to show enemy density, lighting quality, density of visual elements that add to the game's narrative, levels of challenge, and many other things while documenting historic game precedents.

DIAGRAMMING AND SKETCHING NEW IDEAS BASED ON HISTORICAL PRECEDENTS

Diagrammatic drawing can also help designers' transition from studying historic precedents to working on their own designs. Sketching with the criteria of diagramming—emphasizing or calling out vital information, abstracting unimportant elements, and using distinctive visual markings to describe ideas—can help designers develop their own ideas. Figure 4 shows several types of sketches architects might use to describe the basic form of their buildings and the ways that they create space or the ways that occupants may move through them.

Figure 5 shows this process of diagrammatic sketching of new ideas for games. This game in particular is based on the work of Russian Constructivist designer El Lissitzky. These diagrams both document existing artworks by Lissitzky and feature notes suggesting ways that compositional elements from these works might be used to create gameplay for the player, who controls a red wedge-shaped avatar.

Figure 6 then shows the next level of this process, with level geometry derived from a work of one of Lissitzky's contemporaries—moving beyond documentation and into ideation

6. These may be accomplished in a traditional drawing and a detail drawing, respectively.

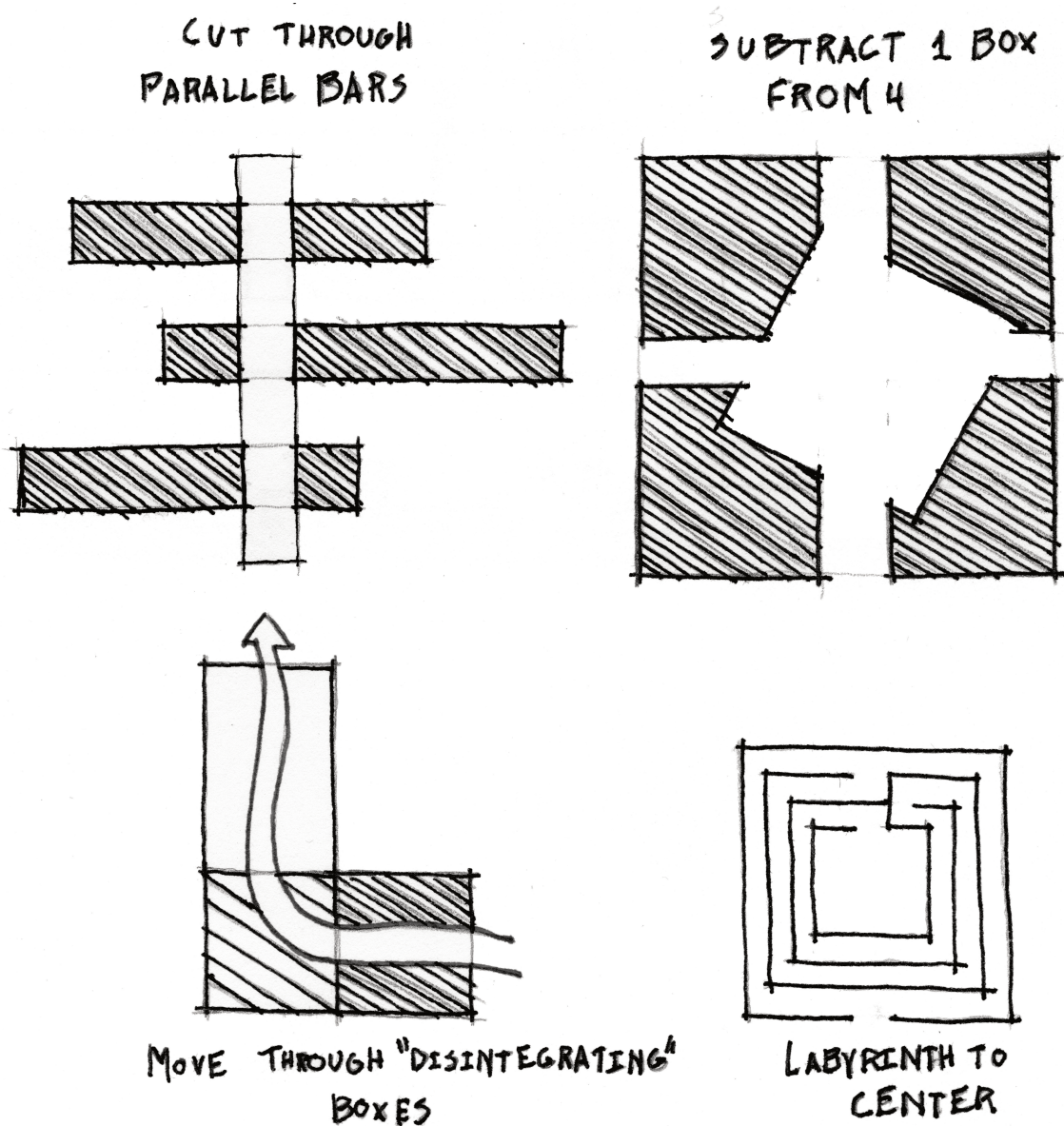

Figure 4. This sketch shows some ideas of how basic building ideas are diagrammed using some of the previously discussed visual language. These types of diagrams are useful for jotting down new ideas quickly before they are developed into more concrete designs. (This image was originally published in Totten (2014) An architectural approach to level design.)

Sketching in this way allows the observer to isolate individual elements of a composition and understand the relationships between objects in them and resembles the type of kinesthetic learning advocated by Froebel and Montessori, where learners explore their world through interaction. (Lerner, 2005, p.221) In the example of the Lissitzky game, exploring the artist's original works allowed the game designer to deconstruct Lissitzky's original compositions and design game mechanics, art assets, and game levels in such a way that they interacted in ways that honored the juxtapositions of shapes in Lissitzky's own works. It also allowed for the design of new compositions with these elements that fulfilled the same aesthetic goals as Lissitzky's designs.

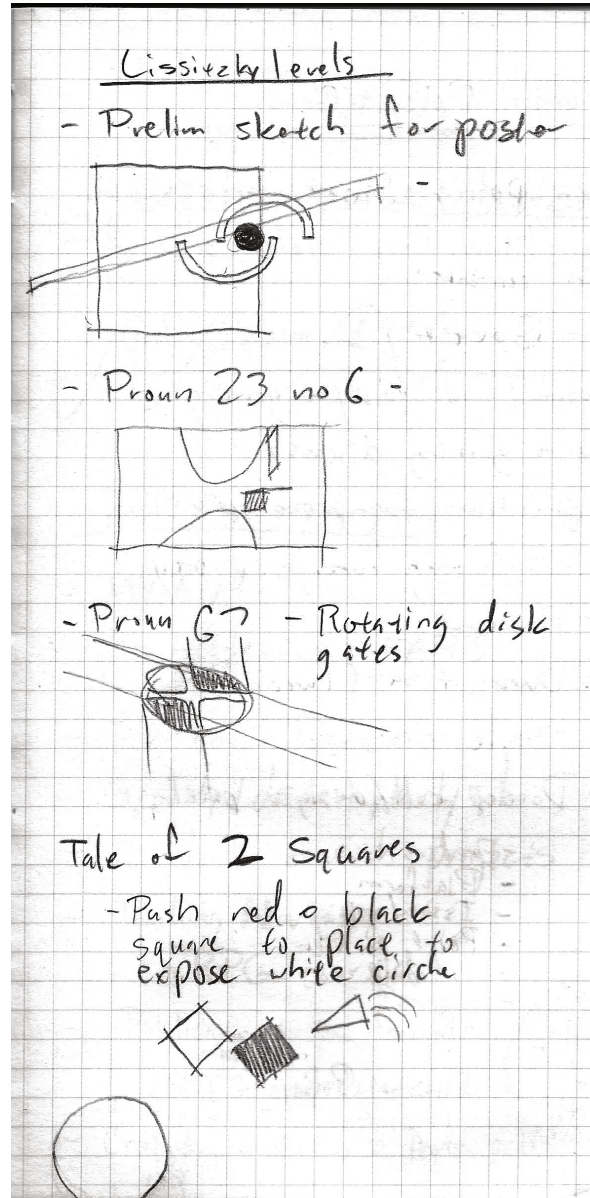

Figure 5. These sketches from a game designer's notebook use diagrammatic language to quickly sketch multiple ideas for interactions between the player avatar and level obstacles.

Now we can see how the process of utilizing art and aesthetic design-based histories as precedents becomes game creation. In terms of games research, this addresses the previously outlined challenges to viewing games in the context of art and aesthetic design by both addressing portions of games as individual designed works (as in the example of analyzing the level design of *Super metroid*) and opening the possibility of utilizing traditional art and design as precedents for game works (in the example of the Lissitzky game.) The final section of this chapter will further describe the Lissitzky game and other works that use this same process and further establish the art and aesthetic design-derived branch of games research.

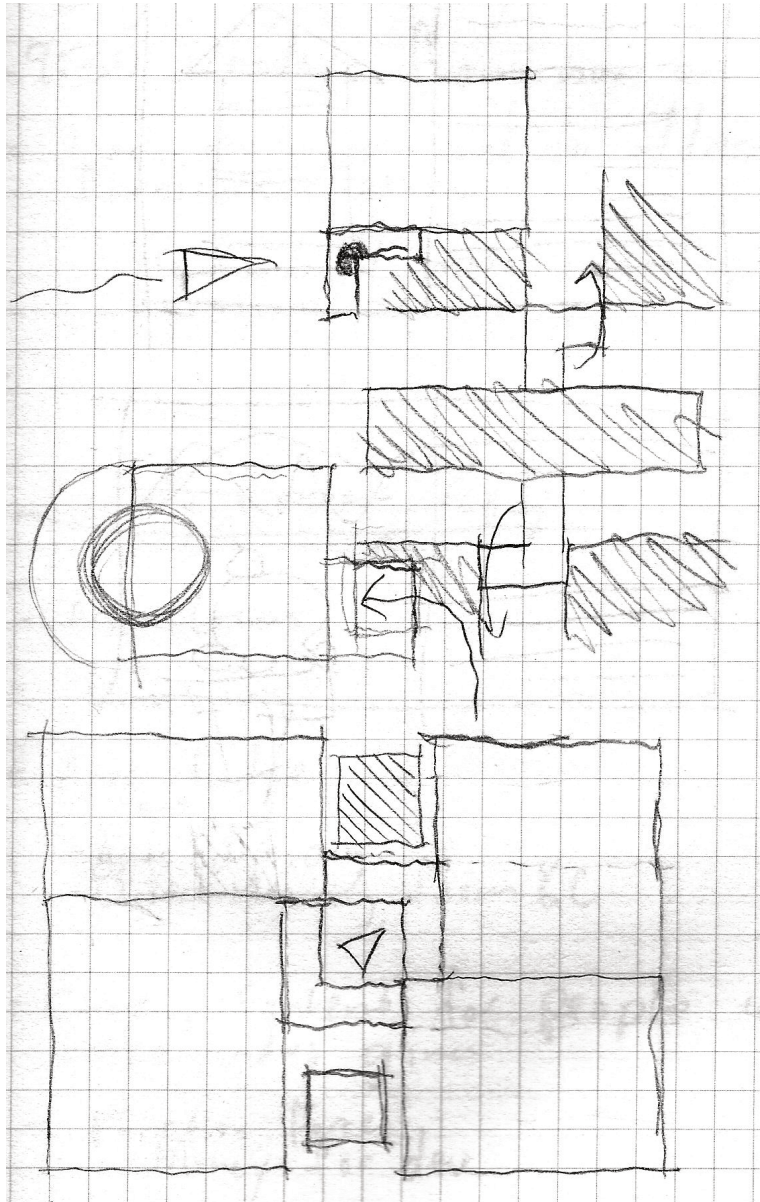

Figure 6. These sketches show puzzle ideas based on Constructivist-style works. Elements from an original work are translated into gameplay mechanics and the game developer is arranging them in new ways to create puzzles that block and trap the player with L-shaped rotating elements

HISTORICAL DESIGN RESEARCH IN GAME DESIGN PRACTICE

Unlike technological or non-design-related research projects that utilize games, art and aesthetic design-centric research projects work towards creating games for the purpose of expanding the design considerations with which games are planned and viewed. These projects typically seek to expand the vocabulary of critical game discourse, invent new methods for play, or experiment with new development methods for games based in the arts. Likewise, projects and histories like the ones outlined previously do not view games as holistic works but also as the work of multiple design professionals. As such, they not only address the *artgames* genre but also the artistic works

that combine to form popular entertainment games. This section highlights several projects that not only experiment with the art and aesthetic design-related aspects of games, but do so in ways that address some of the concerns that critics like Sharp (2015) and Rough (2014) have concerning the relationships the games medium has with these fields.

As Sharp (2015) points out, the *art world* and the game-playing world value different aspects of games, limiting the likelihood that a popular game or one created to entertain would be considered for an art exhibition when viewed as a singular piece. This does not have to be so, however, and games that question game industry tropes through their presentations or generative methods find ways to satisfy both artistic expectations and game expectations. In discussing artgames and the experiences they create, he cites Myfanwy Ashmore's *Super Mario trilogy* (2000–2004), where the artist creates levels for classic *Super Mario Bros.* games that the player cannot win, only wait out the time limit for Mario to die. Where these games subvert solely through mechanics, the work of the “game designer”, indie game *Default Dan* (Kikiwik Games, 2015) accomplishes the same effect of making players reconsider traditional game mechanics through the game's visuals. In *Default Dan*, coins instantly kill players and spikes make the player bounce higher, among other interactions. While the result is the same subversive gameplay interaction, *Default Dan* does so by investigating players' connections with visual assets and questioning designs that make objects “look friendly” or “look dangerous”. Likewise, it places these visual design tropes against the elements of behaviorism, semiotics, and operant conditioning at play in games (Salen and Zimmerman, 2003, p.345) while also providing entertaining and often funny experience typical of traditional games.

Other examples accomplish the same goals of both games and contemporary art by questioning typical ways that games are made and constructed, but also integrate elements of traditional art and aesthetic design. One such project includes game designer Eric Zimmerman and architect Nathalie Pozzi's spatial installation games from 2010 to 2016 (Zimmerman, n.d.), where the games are designed to be played in real-world environments and constructed as explorable spaces that humans can inhabit. These games play with both the barrier between game space and everyday world space and notions of how spatial conditions affect player action through design elements common in architectural practice. One game in this series, *Starry heavens* (Zimmerman and Pozzi, 2015), has players moving on circular disks placed on the ground. A “ruler” calls out when players may make a move and pulls down a cloud-like large balloon and must touch it before one of the players reaches them and becomes the new ruler. Another game in the series, *Cross my heart + hope to die* (Zimmerman and Pozzi, 2010), is a labyrinth of fabric walls where three players—representing the mythological figures Theseus, Ariadne, and the Minotaur—chase one another around while “guard” players protect the others by blocking intersections. The game itself plays with the qualities of space, materiality (the walls are semi-transparent), and notions of architectural allies (Lyndon and Moore, 1996), sculptural figures that occupy a space but are part of the architecture (in this case played by actual players.)

Likewise, the Atelier Games project—a series of games based on the work of established fine artists and art movements—recalls the tools and themes of famous artworks as central elements of game projects. The first game in this series is the previously discussed El Lissitzky-based game *Lissitzky's revenge*. (Totten, 2015) *Lissitzky's revenge* is an action game that used several of Lissitzky's posters as inspiration for the game's mechanics and materials that the artist would have used as the medium with which art for the game was made. (figure 7) The action of the poster *Beat the whites with the red wedge* (Lissitzky, 1919) was inspiration for the game's core mechanics—exposing a white circle to attack by solving puzzles then finishing it off. The game spans five worlds, each themed after a different poster by Lissitzky.

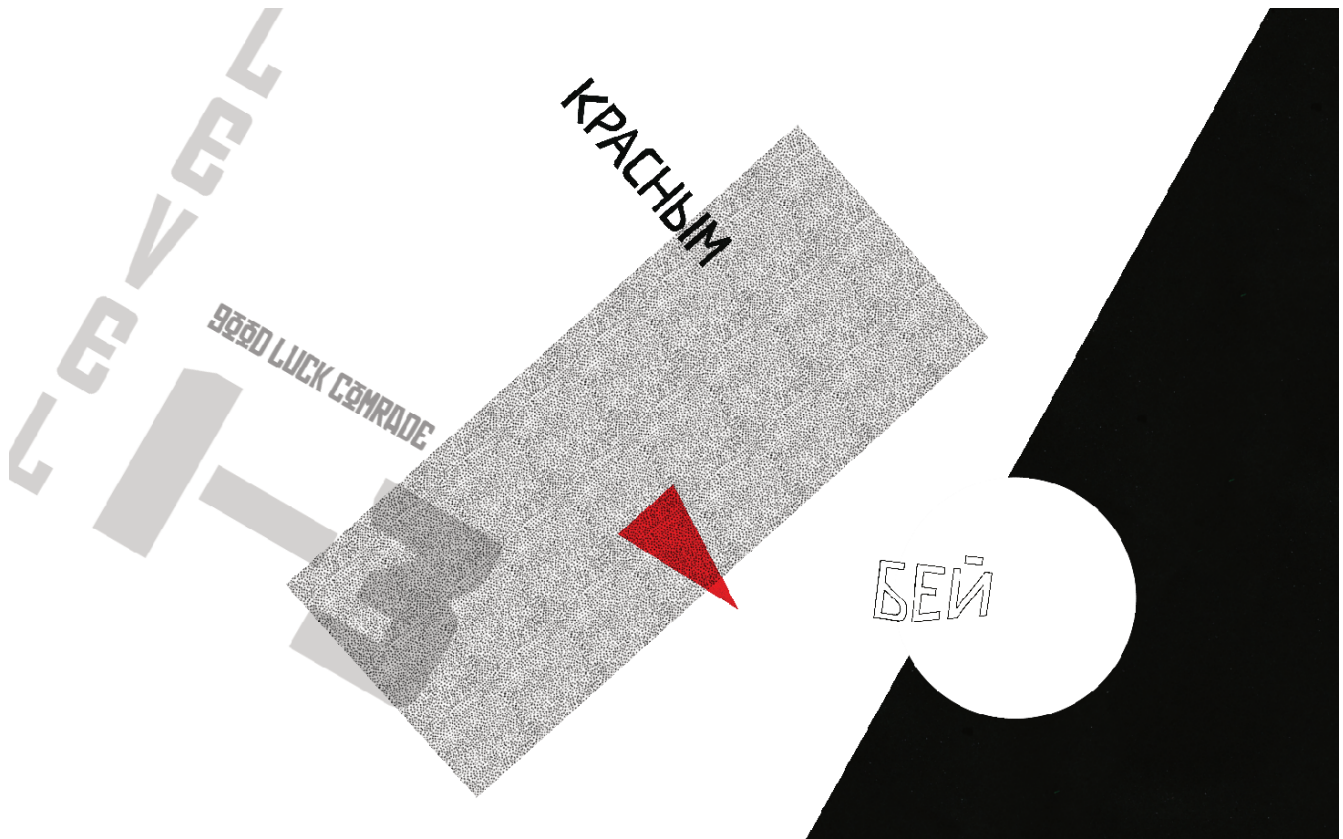

Figure 7. Screenshot of Lissitzky's revenge, showing a level modeled after Lissitzky's poster, Beat the whites with the red wedge.

Each world translates the visual components and compositional aspects of the work upon which it is based as game mechanics, as seen in figures 5 and 6.

Another project in this series, *Addie's patchwork playground* (Sullivan and Totten, 2016), explores quilt making and the traditional grid-and-tile based level construction methods used in many games. Contrasting the fabric patterns of Lotta Jansdotter, who creates stamp-based designs, and Carolyn Friedlander, who makes designs based on architectural hatches, the designers constructed tile-based patch worlds of architectural hatches that players place stamps on as they move a character around the screen. (figure 8)

Like *Lissitzky's revenge*, the designers of *Addie's patchwork playground* utilized hand-drawn methods to create their game art. Blocks of tileable architectural hatching was produced and assembled in such a way that it would resemble the techniques of quilters. Jansdotter-esque stamps appeared behind players as they interacted with different patches, which in some prototypes could be swapped so the stamps that would normally appear on the wood tile might appear on brick tiles. Likewise, an actual quilt was produced to be the controller of the game, using conductive fabric to take input from players.

THE ROLE OF HISTORICAL RESEARCH IN GAME DESIGN RESEARCH

These game development initiatives not only mimic elements of historic design fields, but integrate important theories of design and aesthetic considerations from these fields into asset creation for

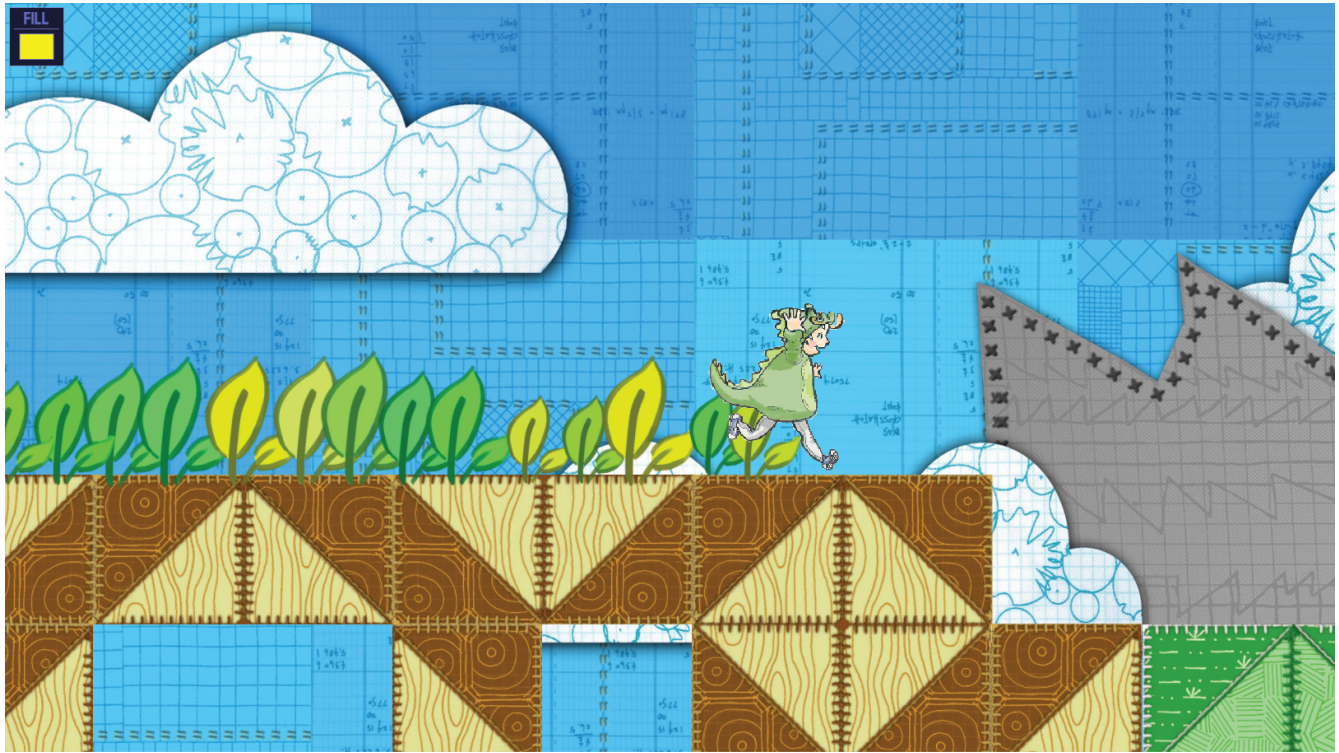

Figure 8. Addie's patchwork playground, a game based on the work of two different fabric designers and constructed like a quilt.

the games. As development practice, the inclusion of design theory seems lacking in practicality, but through techniques like sketching and precedent study, examples of these theories becoming practical design examples are recorded as inspiration for new works. The goal of precedent sketching and observation is to construct your own "design vocabulary" that can be utilized when creating new works. The previous sections' foci on observing games for more than just their gameplay mechanics (holistic design vs. collective work of multiple design professionals) and the call for game designers to utilize knowledge from the fine arts then, serves to broaden the precedents that designers may use to form their vocabulary.

This chapter observed several games exemplary of this process of collecting inspiration from precedents in fine art and aesthetic design and turning them into game design ideas. These games construct holistic designed experiences, like the games valued by many design researchers and critics (Bogost, 2007; Grace, et al., 2015; Sharp, 2015), through thoughtful construction and implementation of visual and audio assets. The elements that make these experiences up: the items in *Default Dan*, the architectural elements of Zimmerman and Pozzi's spatial games, the designer-derived art assets of the Atelier Games, and the controller of *Addie's patchwork playground*, assert themselves as purposefully designed works. Taking care to generate such assets in artistically robust fashions opens the doors not only to new areas of game production and research, but also catches the attention of players, art critics (Meier, 2015), and museums. (Smithsonian American Art Museum, 2015)

Future possibilities for such work includes the exhibition of not only games themselves, as has been described in previous sections, but also displaying the assets that make up these games. In exhibits such as the Smithsonian's (2012) *Art of video games* or Art ludique: Le musée's (2015) *The art in video games—French inspiration*, it is not uncommon to showcase concept artwork used to visualize and

inspire the creation of in-game assets. However, celebrating the artworks that form audio or visual assets for games could provide additional exhibition opportunities and educate visitors on the game-making process, potentially inspiring new creators to learn game making.

CONCLUSION

Though the majority of game research has been driven by social or technological questions, new trends are emerging towards contextualizing games among traditional fields of art and aesthetic design. This shift is emblematic of new methods of viewing games: where once games were considered purely technological, they are now seen as the work of multiple creators in both tech and design. These creators are themselves educated in fields such as fine art, graphic design, architecture, and music composition. The efforts of these creators, or design professionals as Segal (2006) calls them, inspire deep discussions of not only entire games, but also the audio and visual elements that populate the games they contribute to. This is leading designers to strongly consider thoughtful design professionals for asset creation and not simply hire an artist to “tighten up the graphics.”

The relationship between games and these more established fields has also been difficult to reconcile because of questions of how games could fit into the *art world*.⁷ Like the designers who sought cultural relevance for their games through social or technological applications, so called *artgames* sought the standards of art through means that were very different from popular aspects of the games field. Game research that emphasizes games as the work of multiple design professionals rather than as a cohesive whole has the ability to both address the criteria of contemporary art and the concerns of traditional game designers. This research reconciles these previous dissonant goals by creating experiences that reflect and reveal ideas about games and game asset production through their generative methods and providing engaging experiences for players. They also engage the design methodologies of other fields, in particular precedent design, which integrates historic knowledge into new works.

Through these methods, designers, researchers, critics, and players can better integrate games into the broader cultural landscape and expand the language used to discuss games.

BIBLIOGRAPHY

ACM, n.d. Conferences: Foundations of digital games. Available at: <<http://dl.acm.org/event.cfm?id=RE473>>.

Adams, E.W., 2002. The role of architecture in video games. Gamasutra. Available at: <http://www.designersnotebook.com/Columns/047_The_Role_of_Architecture/047_the_role_of_architecture.htm>.

Adams, E.W., 2009. *Fundamentals of game design*. 2nd ed. New Riders.

Ashmore, M., 2000-2004. *Super Mario Trilogy*. [Game trilogy].

Bates, B., 2004. *Game design*. 2nd edition. Cengage Learning.

Bogost, I., 2007. *Persuasive games: The expressive power of videogames*. The MIT Press.

7. The artworld is used to denote the community that in the institutional theory of the art is argued to be part of defining what the art is: the artists, critics, and curators. About institutional theory of art, refer to, Danto (1964) and Dickie (1983).

Ching, F. and Juroszek, S.P., 1998. *Design drawing*. John Wiley & Sons.

Caillois, R., 1961. *Man, play, and games*. 2001. University of Illinois Press.

Danto, A.C., 1964. The artworld. In: P. Lamarque and S.H. Olsen, eds., 2004. *Aesthetics and the philosophy of art: the analytic tradition: an anthology*, Blackwell philosophy anthologies. Blackwell Pub.

Dickie, G., 1983. The new institutional theory of art. In: P. Lamarque and S.H. Olsen, eds., 2004. *Aesthetics and the philosophy of art: the analytic tradition: an anthology*, Blackwell philosophy anthologies. Blackwell Pub, pp.47–54.

DiGRA, n.d. Available at: <<http://www.digra.org/digital-library/> Accessed August 3, 2016>.

Djaouti D., Alvarez J. and Jessel J., 2011. Classifying serious games: the G/P/S model.” In: Felicia, P., ed. *Handbook of research on improving learning and motivation through educational games: Multidisciplinary approaches*. IGI Global.

Donovan, T., 2010. *Replay: The history of video games*. Hove, UK. Yellow Ant.

Duret, C. and Pons C.-H., eds., 2016. *Contemporary research on intertextuality in video games*. IGI Global.

Duro, P., 2007. Imitation and authority: The creation of the academic canon in French art, 1648–1870. In A. Brzyski, ed. *Partisan canons*. Duke University Press, pp. 95–113.

Flanagan, M. 2009. *Critical play: Radical game design*. The MIT Press.

GDC + VRDC, 2016. GDC + VRDC 2016 session schedule: Visual arts track. Available at: <<http://schedule.gdconf.com/track/visual-arts>>.

Gold, S., n.d. IGDA Curriculum framework: The study of games and game development. (PDF), version 3.2 Beta. February 2008. Available at: <www.igda.org/wiki/images/e/ee/Igda2008cf.pdf>.

Green, R. and Green, A., 2014. *That dragon, cancer* [Game].

Hofmeier, R., 2011. *Cart life* [Game].

Holmes, T., 2003. Arcade classics spawn art? Current trends in the art game genre.” In *MelbourneDAC2003*, 46–52. Available at: <<http://hypertext.rmit.edu.au/dac/papers/Holmes.pdf>>.

Howard, J., 2008. *Quests: design, theory, and history in games and narratives*. AK Peters.

Howard, J., 2014. *Game magic: A designer’s guide to magic systems in theory and practice*. CRC Press.

Huizinga, J., 1955. *Homo ludens*. Beacon Press.

Jansen, A., 2012. Game design: The designer class: What does he do?. Gamasutra. Available at: <http://www.gamasutra.com/blogs/AdriaanJansen/20120219/91117/The_Game_Designer_Class__What_does_he_do.php>.

- Johansson, A., 2015. Take note: Why having a sketchbook shouldn't be overlooked." *Fireside*. Available at: <<http://fireside.gamejolt.com/post/take-note-why-having-a-sketchbook-shouldn-t-be-overlooked-ryuy4mwe>>.
- Juul, J., 2014. High-tech low-tech authenticity: The creation of independent style at the independent games festival. In *Proceedings of the 9th International Conference on the Foundations of Digital Games*. Available at: <<http://www.jesperjuul.net/text/independentstyle/>>.
- Kent, S., 2001. The ultimate history of video games: From Pong to Pokemon and beyond. Three Rivers Press.
- Kikiwik Games, 2015. *Default Dan*. [Game].
- Kohler, C., 2012., Videogames politely invade Smithsonian Art Museum. *Wired*. Available at: <<http://www.wired.com/2012/03/art-of-video-games-smithsonian/>>.
- Lerner, F., 2005). Foundations for design education: Continuing the Bauhaus Vorkurs vision. *Studies in Art Education*, 46(3), 211-226. Available at: <<http://www.jstor.org/stable/3497081>>.
- Lyndon, D. and Moore, C.W., 1996. *Chambers for a memory palace*. Cambridge, MA: The MIT Press.
- Maguid, Y., 2016. What can architects learn from *No Man's Sky*?. *Kill Screen*. Available at: <<https://killscreen.com/articles/can-architects-learn-no-mans-sky/>> [accessed August 11, 2016].
- McGonigal, J., 2011. Reality is broken: Why games make us better and how they can change the world. Penguin Publishing.
- Melissinos, C., curator, 2012. *The art of video games*. Washington, DC. Smithsonian American Art Museum.
- Meier, A., 2015. Be the Bolshevik Wedge in a game inspired by El Lissitzky's 1919 propaganda art. *Hyperallergic*. Available at: <<http://hyperallergic.com/198635/be-the-bolshevik-wedge-in-a-game-inspired-by-el-lissitzkys-1919-propaganda-art/>>.
- Mendez, A., 2016. Frost Art Museum presents the ultimate man-cave experience: "The art of video games" exhibition. Miami New Times. Available at: <<http://www.miaminewtimes.com/arts/frost-art-museum-presents-the-ultimate-man-cave-experience-the-art-of-video-games-exhibition-8219546>>.
- Norman, D., 2005. Emotional design: Why we love (or hate) everyday things. Basic Books.
- Orlati, F., 2014. *Ever yours, Vincent*. [game]. Available at: <<http://gamejolt.com/games/ever-yours-vincent-demo/41498>>.
- Ormiston, R., 2014. *50 art styles you should know*. Prestel.
- Pajot, L. and Swirsky, J., 2012. *Indie game: The movie*. [DVD]. Blinkworks.
- Prager, P., 2014. Making sense of the modernist muse: Creative cognition and play at the Bauhaus. in *the American Journal of Play*. 7(3), 27-49.

- Rogers, S., 2010. *Level up! The guide to great game design*. Hoboken, NJ: Wiley.
- Rough, B., 2014. Why video games in art museums still aren't art." *Aesthetics for Birds*. <http://www.aestheticsforbirds.com/2014/02/why-video-games-in-art-museums-still.html>
- Ruckstuhl, F.W., 1917. Idealism and realism in art" *The art world*, 1(4), 252–256. Available at: <http://www.jstor.org/stable/25587740?seq=2#page_scan_tab_contents>.
- Salen, K. and Zimmerman, E., 2003. *Rules of play: Game design fundamentals*. MIT Press.
- Schwendener, M., 2014. Viewing video games from another level: A review of 'The art of video games' at the Hudson River Museum in Yonkers. *The New York Times*. Available at: <<http://www.nytimes.com/2014/04/06/nyregion/a-review-of-the-art-of-video-games-at-the-hudson-river-museum-in-yonkers.html>>.
- Segal, P., 2006. *Professional practice: A guide to turning designs into buildings*. W.W. Norton & Company.
- Sharp, J., 2015 *Works of game*. MIT Press.
- Silbur, D., 2015. *Pixel art for game developers*. CRC Press.
- Smithsonian American Art Museum, 2015. Innovation in Art. Art showcase event.
- Sullivan, A. and Totten, C.W., 2016. *Addie's patchwork playground*. [Game].
- Sutton-Smith, B., 1997. *The ambiguity of play*. Cambridge, MA: Harvard University Press.
- Swain, C., 2007. Designing games to affect social change. In *Proceedings of the 2007 DiGRA international conference: Situated play*. Available at: <<http://www.digra.org/digital-library/publications/designing-games-to-effect-social-change/>>.
- Totten, C.W., 2014. *An architectural approach to level design*. CRC, Taylor & Francis Group.
- Totten, C.W., 2015. *Lissitzky's Revenge*. [Game].
- Totten, C.W., 2016. Moving forward by looking back: Using art and architectural history to make and understand games. In C. Duret and C.M. Pons, eds. *Contemporary research on intertextuality in video games*. IGI Global.
- Totten, C.W., 2013. Teaching serious game app design through client-based projects. In: *Proceedings of the 2013 DiGRA international conference: Defragging game studies*. Available at: <<http://www.digra.org/digital-library/publications/teaching-serious-game-app-design-through-client-based-projects/>>.
- Zimmerman, E., n.d. Eric Zimmerman—Projects. Available at <<http://ericzimmerman.com/portfolio/>>.

CHAPTER 4

INVESTIGATING GAME DESIGN METHODS AND MODELS

JORIS DORMANS AND JUSSI HOLOPAINEN

A great number of game design guidelines, methods, theories, models, and tools have been developed over the past years. Some of these were developed specifically to assist the design process, while others were developed as analytical tools, work methods, or documentation techniques (for overviews see, for example, Lindley and Sennersten, 2008; Almeida and de Silva, 2013; Neil, 2012; Klabbers, 2003). The main approaches and attempts to assist game designers that have been developed up until now and that are discussed in this chapter are: design documents, the MDA framework, play-centric design methodologies, game vocabularies, design patterns, finite state machine diagrams, Petri nets, and finally different types of game diagrams. Most of these methods were not developed as design tools, yet all of them can be used as such or might have an impact on the development of new design methods and tools. This chapter discusses the merits of these methods for the purpose of developing design methods and tools.

The reader should note that the common discourse about these methods is quite diffuse. Within the game industry, and to a lesser extent within game research too, there is no fixed vocabulary. Many concepts are used quite informally, and terminology frequently overlaps or even conflicts. For example, the term *game design document* captures a wide variety of different documents that are created for as many different reasons. We have tried to use the original terminology as much as possible, hopefully without creating too much confusion. Furthermore, there seems to be little distinction between analytical methods and design methods and the two terms are sometimes used interchangeable. In this chapter we are following the inclusive definition suggested by Cross and Roy (1989, p.46): “Design methods can, therefore, be any procedures, techniques, aids or tools for designing”.

DESIGN DOCUMENTS

In games one common approach to design is to create a plan and then execute it. This approach, which on the one hand builds on the fairly naive notion that games can be designed up front, is rooted in the very pragmatic reality in which most game studios find themselves. Game development is done in large teams comprising a wide variety of technical and creative disciplines. Game companies need to keep some form of control over the design despite the large number of individuals involved in the development of the final product. To this end, almost every game company creates design documents that outline the vision and details of a game’s design. Although not a design method as such, this practice does shape the way games are designed in big-budget, commercial settings.

On the Internet many different templates for game design documents can be found that are used by different companies, and virtually every book that discusses game design has its own template. The notion and practice of design documents is as diffuse as it is diverse. There are many different reasons to write these documents, and there are many different moments in the design process in which companies do so. Game design documents are sometimes used to record designs before they are built, and sometimes they are used to record designs after the games have been built. They typically contain descriptions of a game's core mechanics, level designs, notes on art direction, characters and their backgrounds, and so on. Some advocate lengthy detailed descriptions covering every detail of a game, while others favor brief documents that capture design targets and design philosophy.

Over the years, writing game design documents has become a common industry practice, although no standard emerged that describes how, when or to what purpose these documents should be written. It is not uncommon to produce an entire set of documents, each focusing on a different part of the design or facilitating a different stage of the design process (for example, Adams and Rollings, 2007; Rogers, 2010). The fact that most design documents have their own style and use their own unique concepts to describe games does not help to create a generic body of knowledge beyond the scope of each individual project or company.

Additionally, design documents might not be the right tool to deal with the dynamic, emergent behavior of games. Game design documents written before any prototypes are made are the equivalent of requirements documents in software engineering. A requirements document lists the requirements and functionality of a new, custom-built software application. Its creation is one of the first steps in the *waterfall method* of developing software, in which each step is completed before proceeding to the next step. This document is typically written before the software is built and frequently is part of the agreement between contractor and client. The waterfall method assumes that all requirements are known and can be recorded before the software is built. Within software engineering creating and documenting functional designs is a time-tested practice, although, with the recent popularity of agile development methods, the practice of writing complete functional designs as a blueprint for a new software application has lost its appeal (cf. Larman and Basili, 2003).

There are three important differences between designing games and business applications using a waterfall method that make it difficult or inefficient to transfer the practice from general, custom software development to game development:

1. Game design is a highly iterative process; no matter how experienced a designer is, chances are that the design of a game is going to change as it is being built. Due to the emergent nature of games it is often impossible to accurately predict the behavior of a game before it is implemented.
2. Not all games are created within a contractor-client context. Without this context there is less need to document the design before the game is built.
3. Regular commercial software is commonly built with code upkeep and future development in mind, for games this is not always the case, as many games are developed as one-off products sold for a fairly brief period. This reduces the necessity to create documentation that aids future developers. Despite the fact that many sequels are produced in the game industry, many of the sequels are built from scratch, surprisingly little code is being reused. From the perspective of software engineering this is a bad practice. However, as the development techniques are still evolving fast and a new generation of hardware becomes

available roughly every five or six years this practice makes more sense from the perspective of the game industry.

Many designers regard the game design document as a necessary evil, and some have dismissed the practice entirely (Kreimeier, 2003). Everyone agrees that designs need to be documented and communicated to the team, but in practice people hardly look at design documents (Keith, 2010, pp.85–87). Stone Librande, creative director at Electronic Arts, experimented with a technique he calls one-page designs to circumvent some of these problems (Librande, 2010). His approach is to create design documents that are more like data visualizations instead of multi-page, written texts. One-page design documents are posters that capture the essence of a game visually. These documents have four advantages over the traditional design documents:

1. Most designers find them more interesting to create, making the task of creating a design document less tedious.
2. Because there is a spatial constraint (although the size of the page is left to the whims of the designer), the designer is forced to focus on the essence of the game. This makes the document a better match for the agile development process often found in games.
3. As people tend to like the way these documents look, they tend to stick them to walls, increasing their exposure and impact.
4. Stone Librande suggests leaving plenty of whitespace on the documents in order to invite team members to scribble notes on them. This keeps the documents up to date.

One-page design documents solve some of the problems associated with design documents, but not all. There is still no standard for documenting gameplay, mechanics and rules. Each one-page design document is created for a particular game, and although the product should be understandable and communicative, it cannot set a standard. In addition, the lack of detail, which makes a one-page design document more flexible and therefore is one of its strengths, makes it less suited to record designs; one-page design documents are very good at capturing the design vision, goals and direction, but they cannot function as a technical blueprint at the same time.

THE MDA FRAMEWORK

The MDA framework, where MDA stands for *mechanics*, *dynamics* and *aesthetics*, has been used to structure game design workshops at the *Game developers conference* (GDC) since 2001. In contrast to the practice of game design documents, the MDA framework quite consciously tries to present a generic approach to the difficulties involved in designing games. It has been quite influential and it seems to be one of the most frequently recurrent frameworks found in university game design programs all over the world. It probably is the closest thing the industry has to a standardized game design method.

The MDA framework breaks down a game into three components: *mechanics*, *dynamics* and *aesthetics*, which correspond to the game's rules, its system, and the fun it brings (Hunicke, et al., 2004). The MDA framework teaches that designers and consumers of games have different perspectives on games. Where a consumer notices the *aesthetics* first and the *dynamic* and *mechanics* afterwards, a designer works the other way round. A designer creates *mechanics* first and builds *dynamics* and *aesthetics* on top them (see, figure 1).

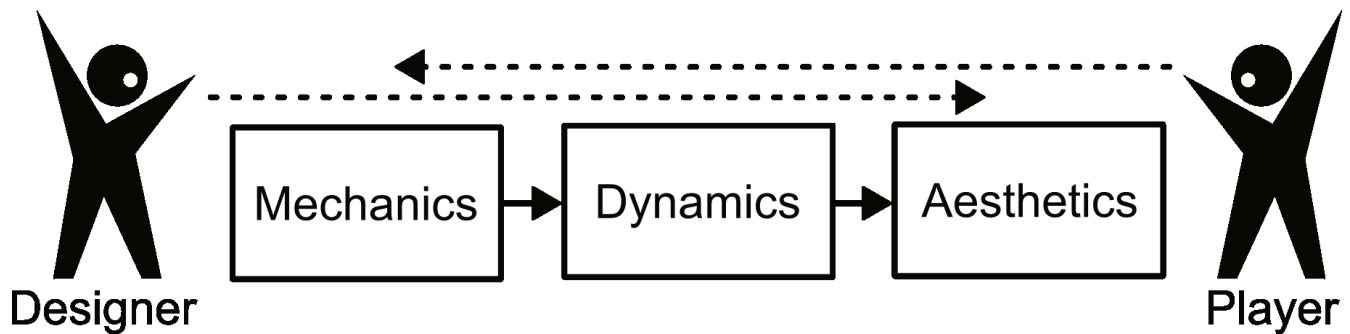

Figure 1. MDA framework.

The MDA framework is designed to support an iterative design process and to help designers to assess how changes in each layer might affect the game as a whole. Each layer has its own design goals and effects on the game. *Mechanics* determine the actions a game allows and it affects the game's dynamic behavior. The *dynamics* layer addresses concepts such as randomness and complexity to explain a game's behavior. Finally, the *aesthetics* layer is concerned with the game's emotional target: the effect it has on the player. The MDA framework describes eight types of fun as prime aesthetic targets. The eight types of fun are: sensation, fantasy, narrative, challenge, fellowship, discovery, expression and submission (Hunicke, et al., 2004; LeBlanc, 2004).

Despite the influence of the MDA framework and the long running GDC game design workshop, as a conceptual framework the MDA never seems to have outgrown its preliminary phase. The distinction between the *mechanics* and *dynamics* layers is not always clear, even to the original authors (see Leblanc, 2004). The *mechanics* are clearly game rules. But the *dynamics* emerge from the same rules. Yet, the original MDA paper places game devices such as dice or other random number generators in the layer of the *dynamics*. To us, those devices would seem more at home in the layer of the *mechanics*. Likewise, the *aesthetics* layer seems to contain only the player's emotional responses. The visuals and story that cue these responses, which would commonly be understood as being part of an aesthetics, seem absent from the framework. The eight kinds of fun comprise a rather arbitrary list of emotional targets, which is hardly explored with any depth. Apart from short one-sentence descriptions, Hunicke, et al. (2004) do not provide exact descriptions of what the types of fun entail. They do state their list is not complete, but they do not justify why they describe these eight, or even hint at how many more types of fun they expect to find. What is more, the whole concept of fun as the main target emotion of games has been criticized by Ernest Adams and Andrew Rollings (2007, p.119) and Steven Johnson (2005, pp.25–26), among others. Games can aspire to target a much wider variety of emotional responses. Some additional MDA articles (e.g., LeBlanc, 2005) have appeared over the years but they have not taken away these concerns. Walk, et al. (2017) give a summary of the criticism and present their own *design, dynamics, and experience* (DDE) framework addressing some of the concerns raised above.

PLAY-CENTRIC DESIGN

A more thorough method of iterative game design is described by Tracy Fullerton, et al. (2006). Coining the term *play-centric design* to describe their method, Fullerton, et al. advocate putting the players at the heart of a short design cycle. They advise that game prototypes are built quickly and tested often. Because of the short design cycle more innovative options can be explored with a reduced risk measured in effort and time.

Play-centric design distinguishes between two levels in a game: the formal core and a dramatic shell surrounding it. A game's formal core consists of rules, objectives and procedures whereas the dramatic shell consists of premise, character and story. Combined, these two layers contribute to the dynamic, emergent behavior that supports play. It is the objective of play-centric design to tune this behavior into a specific target experience. In this context Fullerton, et. al., restate Katie Salen and Eric Zimmerman's (2004, p.168) description of games as a *second-order design problem*. A designer designs the game, but the game delivers the experience; the designer does not create the experience directly.

Involving the player in the design process is currently commonplace in both academia and development studios (Isbister and Schaffer, 2015). The human-centered design or user-centered design, originating from software engineering, has been a big influence on this trend. It should come as no surprise that Microsoft's game studios are front-runners in this respect, as Microsoft has much experience with similar methods used in regular software development. Pagulayan, et al. (2003) describe the heuristics and structured user tests that have been used to develop several games within Microsoft. Slowly but surely these methods have become an integral part of designing games, and more and more these methods rely on a combination of qualitative methods such as heuristic evaluations (Sweetser, 2005; Schaffer, 2008) and quantitative game analytics (for an overview see, Seif El-Nasr, Drachen and Canossa, 2013).

Play-centric design focuses on the process of designing games. By structuring the design process, involving the player, gathering data from prototypes, and iterating many, many times everything is done to ensure that the end product, the finished game, is as good as the design team can make it. For a professional game designer these methods are (or at least should be) regular tools of the trade. They do not make the process of designing games less hard, but they do help the designer to stay on track, break the task down into a series of smaller subtasks, and steadily progress towards a high quality end product. Play-centric design is akin to the agile development methods that today seem ubiquitous in game development. Agile methods, SCRUM in particular, also breaks down the development process into small, manageable chunks. However, agile methods are quite agnostic about what is being developed; they focus on managing the process, not the product.

With the proper methods and tools this process can be refined. The play-centric approach would benefit from methods that can speed up iterations or increase the improvements that are made in each one. There are several types of methods that seem applicable. Certainly formal models of game design are widely accepted amongst them, but also techniques to gather and process data collected during play-tests.

GAME VOCABULARIES

Not only designing games is a hard task, talking about them is already difficult: there is no common language to describe their inner workings as Greg Costikyan (1994; 2002) has famously lamented. There are plenty of books and articles that discuss games as rule-based systems, but almost all of these choose their own words. More often than not, these vocabularies are very good at describing particular games, but they rarely transcend into a more generic vocabulary.

In a 1999 *Gamasutra* article, Doug Church (1999) sets out to create a framework for a common vocabulary for game design. According to this framework, a game design vocabulary should consist of "formal abstract design tools", where *formal* indicates that the vocabulary needs to be precise, and *abstract* indicates the vocabulary must transcend the particularities of a single game. For Church the

vocabulary should function as a set of tools, where different tools are suited for different tasks, and not all tools are applicable for a particular game.

Doug Church describes three formal abstract design tools in his article:

- *Intention*: Players should be able to make an implementable plan of their own creation in response to the current situation in the game world and their understanding of the game play options.
- *Perceivable Consequence*: Game worlds need to react clearly to player actions; the consequences of a player's action should be clear.
- *Story Games* might have a narrative thread, whether designer-driven or player-driven, that binds events together and drives the player forward toward completion of the game.

These three tools form a list that is by no means complete or exhaustive; Doug Church did not intend it to be exhaustive. Between 1999 and 2002 the *Gamasutra* website hosted a forum where people could discuss and expand the framework. The term *design tool* was quickly replaced by the term *design lexicon* indicating that the formal abstract design tools seem to be more successful as an analytical tool than a design tool. Bernd Kreimeier (2003) reports that “at least 25 terms were submitted by almost as many contributors”. As a project the formal abstract design tools has been abandoned. There are, however, several researchers and designers that carry on the torch that Doug Church lit. The *400 Project* initiated by Hal Barwood and Noah Falstein is one example (Falstein, 2002). Barwood and Falstein set the goal of finding and describing 400 rules of game design that should lead to better games. The project website lists 112 rules. Unfortunately the project seems to be abandoned as well: the last update to the website was in 2006.

Craig Lindley (2003) uses orthogonal taxonomies to map games onto a hypothetical space defined by dominant game forms such as *narratology* (focus on story), *ludology* (focus on gameplay) and *simulation* (focus on realism). Individual games can be mapped to the space depending on their relative closeness to each of these extremes (see figure 2). Lindley describes a few possible, complementary taxonomies using one-, two- and three-dimensional spaces. He designed these taxonomies as a high level road map to inform the design team of the intended design target of a particular game project. The taxonomy also suggests suitable tools and techniques borrowed from other fields: a game that veers towards the narrative side will benefit more from traditional storytelling techniques than a game that is a simulation first and foremost. Lindley's game taxonomies provide a systematic framework in which many of the formal abstract design tools can be embedded, providing structure to what otherwise would remain a loose collection of labels.

The game ontology project takes the notion of a common vocabulary for games into yet another direction. This project attempts to order snippets of game design wisdom into one large ontology. An ontology is a large classification scheme that has a hierarchical organization. Each entry in the ontology describes a common structure found in games. It lists strong and weak examples of the structure and lists parent and children categories. For example, the ontology entry *to own* is used to describe the game structure in which game entities can own other game entities. An example would be the game entity Mario that collects mushrooms and stars, and so on. *To own* is a child of the *entity manipulation* entry which, in turn, has three children: *to capture*, *to possess*, and *to exchange* (Zagal, et. al., 2005).

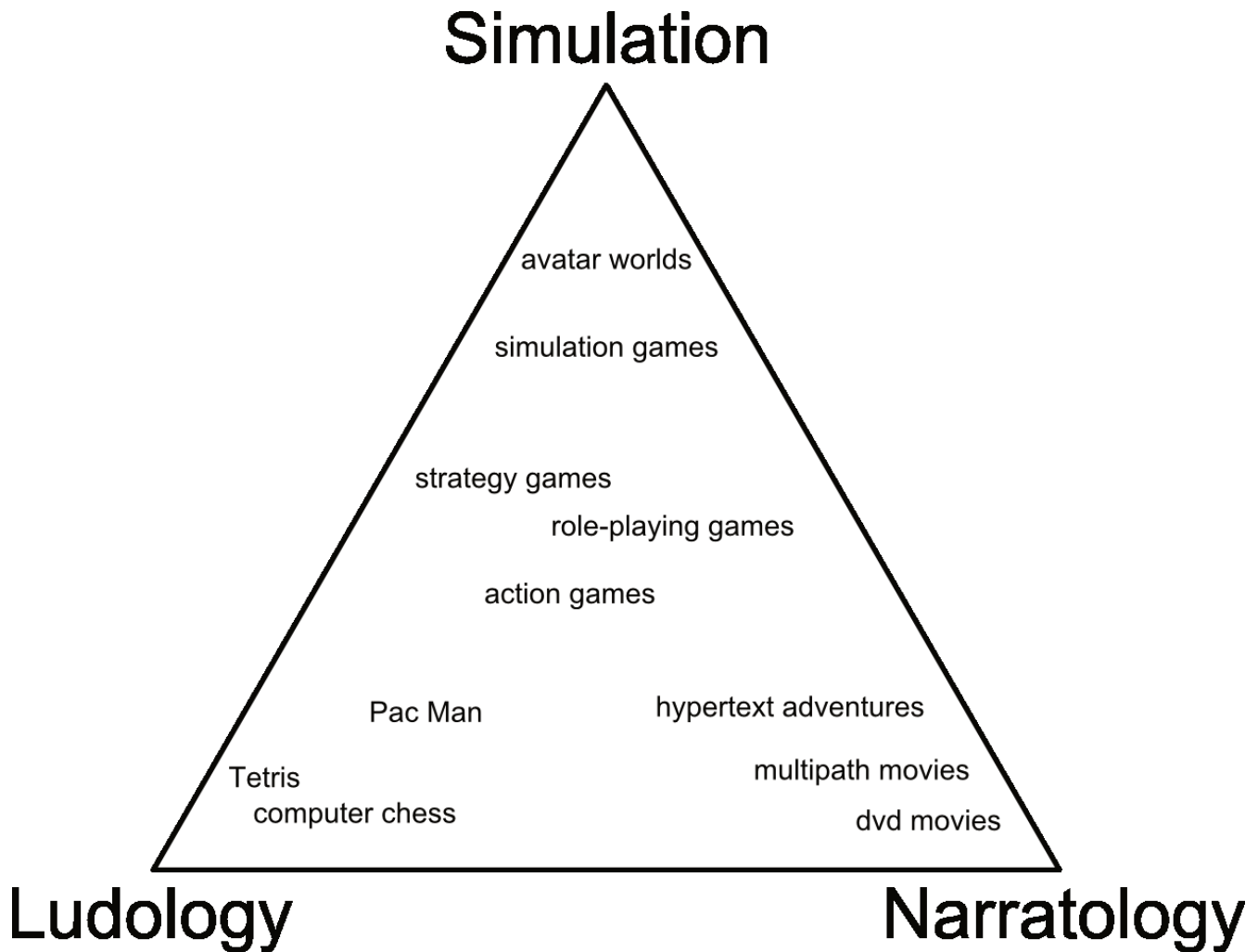

Figure 2. Lindley's taxonomy.

The game ontology project aims to explore the design space of games without prescribing how to create good games. More than Doug Church's (1999) formal abstract design tools, it primarily is an analytical tool; it aims at understanding games rather than building them. This is a general characteristic of this and other game vocabularies. Their success as an analytical tool does not translate easily to being successful as a design tool. Obviously, the development of a high level, consistent language to describe common game structures will help designers in the long run, and, as all the vocabulary builders point out, can be a great help in mapping the relatively unexplored areas of the game design. In fact, all authors describe how their vocabularies can be used as a brainstorming tool, simply by selecting and exploring random combinations of notions describing common aspects of games. However, no matter how useful this practice can be, it can usually only help with generating ideas. This is only a small part of the entire process of building a game, yet it requires considerable investment on the part of designers who must familiarize themselves with many new concepts to learn the vocabulary. The game ontology project, for example, consists of over one hundred separate entries, each of which ties in with several other entries in the ontology. For game developers it can be difficult to see what is the actual return on their investment in learning a vocabulary of that size.

The many different approaches towards a common vocabulary for games aggravate this problem. Every vocabulary has its own unique approach and terminology. Simply determining where and how all these approaches overlap or collide makes an extensive academic research project in itself. Even when a game designer invested the time and effort to learn one of these vocabularies, effectively working together or sharing knowledge with somebody who has learned a different vocabulary is still going to be a problem. The only thing all these vocabularies seem to share is their rejection by game designers. In the words of Daniel Cook (2006): “Academic definitions of game design contain too many words and not enough obvious practical applications where people can actually use the proposed terminology”.

DESIGN PATTERNS

Staffan Björk and Jussi Holopainen’s (2005) work on game design patterns also seeks to address the lack of vocabulary for game design. However, their approach is slightly different as they drew inspiration from the design patterns found in architecture and urban design as explored in the works of Christopher Alexander. According to Alexander: “There is a central quality which is the root criterion of life and spirit in a man, a town, a building, or a wilderness. This quality is objective and precise but it cannot be named” (Alexander, 1979, p.ix). His pattern language is designed to capture this quality. Patterns are presented as problem and solution pairs, where each pattern presents a solution to a common design problem. These solutions are described as generically as possible so that they might be used many times (Alexander, et al., 1977, p.x). The patterns are all described in the same format. Each pattern also has connections to larger and smaller patterns within the language, where smaller patterns help complete larger patterns (Alexander, et al., 1977, p.xii).

This idea has been transferred to the domain of software design by Erich Gamma, Richard Helm, Ralph Johnson and John Vlissides (1995). Within software engineering the principles of object-oriented programming take the place of Alexander’s unnamed quality. Software design patterns are a means to record experience in designing object-oriented software (Gamma, et al., 1995, p.2). Today, software design patterns are common tools in teaching and designing software.

A pattern framework for game design following these examples was suggested by Bernd Kreimeier (2002). However, Björk and Holopainen break away from existing design patterns. According to them, design patterns as problem-solution pairs do not suit game design because:

First, defining patterns from problems creates a risk of viewing patterns as a methodology for only removing unwanted effects of a design rather than tools to support creative design work. Second, many of the patterns we identified described characteristics that more or less automatically guaranteed other characteristics in the game, in other words, the problem described in a pattern might easily be solved by applying a related and more specific pattern. Third, the effect of introducing, removing, or modifying a game design pattern in a game affected many different aspects of the gameplay, making game design patterns imprecise tools for solving problems mechanically. However, we believed that game design patterns offer a good model for how to structure knowledge about gameplay that could be used both for design and analysis of games.

Based on these conclusions, we have chosen to define game design patterns in the following fashion: game design patterns are semiformal interdependent descriptions of commonly reoccurring parts of the design of a game that concern gameplay. (Björk and Holopainen, 2005, p.34)

This decision makes their pattern approach indistinguishable from the game vocabularies discussed above and subjects it to all the associated problems. Their book contains hundreds of patterns, and their website (gameplaydesignpatterns.org) has hundreds more. This is indicative of Björk and

Holopainen's dedication to their framework, but also of the fact that their patterns are not built on a strong theoretical notion of what games are and how gameplay emerges from game parts. Their mention of games as state machines (Björk and Holopainen, 2005, p.8) is not enough to carry the weight of the whole framework. The number of patterns used by software engineering, by contrast, is much lower: a typical introduction has about twenty patterns. We doubt that the diversity of problems and solutions encountered in games is one order of magnitude larger than those encountered in software engineering. The real difference is that software design patterns are based on the principles of object-oriented software design. This gives the patterns focus and provides leverage on the problems they need to deal with, leading to patterns that are further abstracted from typical applications or implementations. Without a clear theoretical vision on games, drafting patterns becomes an exercise in cataloguing reoccurring parts of games, without ever questioning why they reoccur or whether these and related patterns might be the result of some deeper mechanism at work within games. Where Christopher Alexander (1979) starts from the notion that his design patterns ultimately allow us to approach some quality that cannot be named, but which is objective nonetheless, the game design patterns lack a similar theoretical focal point.¹

Design patterns work well for architecture and software engineering because they codify a particular quality in their respective domain. In order to replicate their success for game design, a similar notion of quality within games should serve as its foundation. Unfortunately, Björk and Holopainen do not formulate such a quality for games. Without such a quality no set of game design patterns can be anything more than a vocabulary of games. It is worth noting, however, that there are other game design pattern approaches than Björk and Holopainen's one. Liukkonen et. al. (2015), for example, provide an overview and taxonomy of existing game design pattern collections.

MAPPING GAME STATES

Games can be, and often are, understood as state machines: there is an initial state or condition and actions of the player (and often the game, too) can bring about new states until an end state is reached (e.g., Järvinen, 2003; Grünvogel, 2005). In the case of many single-player video games either the player wins or the game ends prematurely. The game state usually reflects the player's location, the location of other players, allies and enemies, and the current distribution of vital game resources.

There are several techniques to represent state machines. Finite state machine diagrams, for example, represent state machines with a finite set of states and a finite set of transitions between states. One state is the initial state and there might be any number of end states. To represent a game as a finite state machine, all the states the game can be in need to be identified. Next all possible transitions from state to state need to be identified. For certain simple games this works.

Petri nets are an alternative modeling technique suited for game machines that are explored by a few researchers (Natkin and Vega, 2003; Brom and Abonyi, 2006; Araujo and Roque, 2009). Petri nets work with a system of nodes and connections. A particular type of node (places), can hold a number of tokens. In a Petri net a place can never be connected directly to another place, instead a place must be connected to a transition, and a transition must be connected to a place. In a classic Petri net places are represented as open circles, transitions are represented as squares and tokens are represented as smaller, filled circles located on a place. In a Petri net tokens flow from place to place; the distribution

1. Although it must be noted that Alexander's pattern language also includes several hundred described patterns. In that sense game design patterns are not very dissimilar. However, Alexander's pattern language describes a fairly large number of domains: buildings, towns, and so on. The sets that describe each individual domain are much smaller.

of tokens over spaces represents the current state of the Petri net (see figure 3). This way the number of states a Petri net can express is much larger than with finite state machine diagrams. Petri nets put much more focus on the transitions and have a natural way of representing integer values through the distribution of tokens over the places in the network. Indeed, “Petri Nets tend to be, in general, a more economic representation when state-space complexity increases” (Araujo and Roque, 2009).

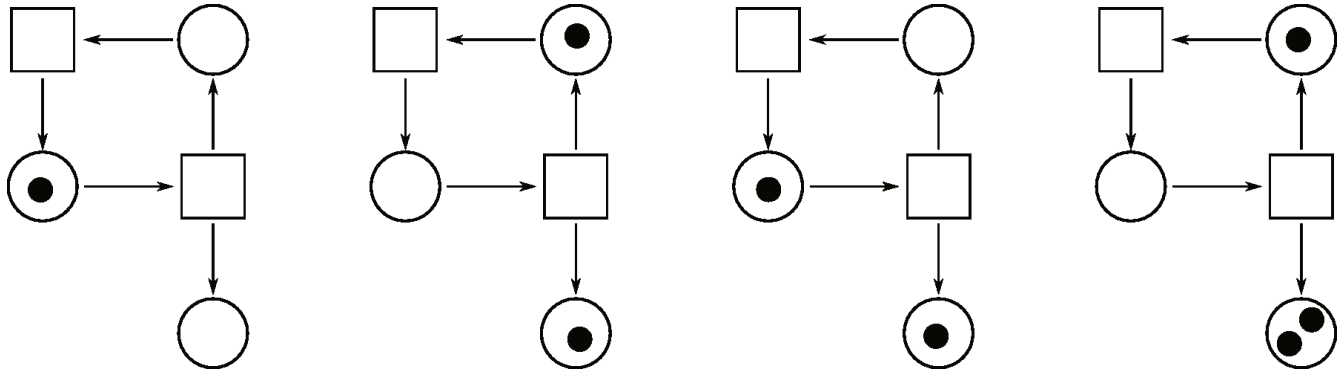

Figure 3. Four iterations of the same Petri net showing movement of tokens through the network

One of the very promising advantages of the use of Petri nets, is that, like state-machines, they have a solid mathematical foundation, but at the same time their expressive range is larger. Petri nets can be easily verified and simulated. They are almost like a visual programming language. But this advantage often is a double edged sword. Petri nets can model a complete game with a high level of detail, but this frequently leads to quite complex diagrams which try to capture a game in its entirety. Petri nets can become the equivalent of a game’s source code, and just as inaccessible to a non-programmer.

GAME DIAGRAMS

State machine diagrams and Petri nets are not the only diagrammatic approaches to deal with the problem of game design. Over the years, a few other diagrammatic or systematic approaches have been developed that deal with games exclusively. Game theory as invented by John von Neumann, can be seen as one of the earliest attempts to deal with game-like systems that feature a similar state-space explosion as we have seen with finite state machine diagrams. One could try to map this sort of systems with decision trees, but they would quickly grow out of control. Instead, game theory uses matrices to chart the gains or losses of possible moves in relation to the opponent’s move. From these matrices rational strategies, or the lack thereof, should become apparent (see Binmore, 2007). Emmanuel Guardiola and Stéphane Natkin (2005) use similar matrices to represent all possible interactions between a single player and a computer game. Game theory and its application in computer games focuses on the actions of the players. It is a very useful technique to balance actions and prevent dominant strategies to emerge. Game theory works best with relatively simple, two-player games; it seems to restrict itself mostly to a formal theory of gameplay decisions, which in itself is a relevant subset of game design. However, it does not scale very well to the scope of modern computer games, which includes much more elements (cf. Salen and Zimmerman, 2004, pp.231–243).

Raph Koster’s exploration in game diagrams presents yet another approach. Presented at the Game Developers Conference in 2005, his focus is on atomic particles that make up the game experience: on what he calls the *ludemes* and devising a graphical language for them (Koster, 2005). These ludemes are essentially the core mechanics of a game. Koster proposes to harvest ludemes by reverse engineering existing games. Sadly, as Koster points out himself, he does not succeed. Figure 4 shows his best take

on diagramming *Checkers*. He believes games can be diagrammed, but he also admits that the language he came up with is not sufficient for the task.

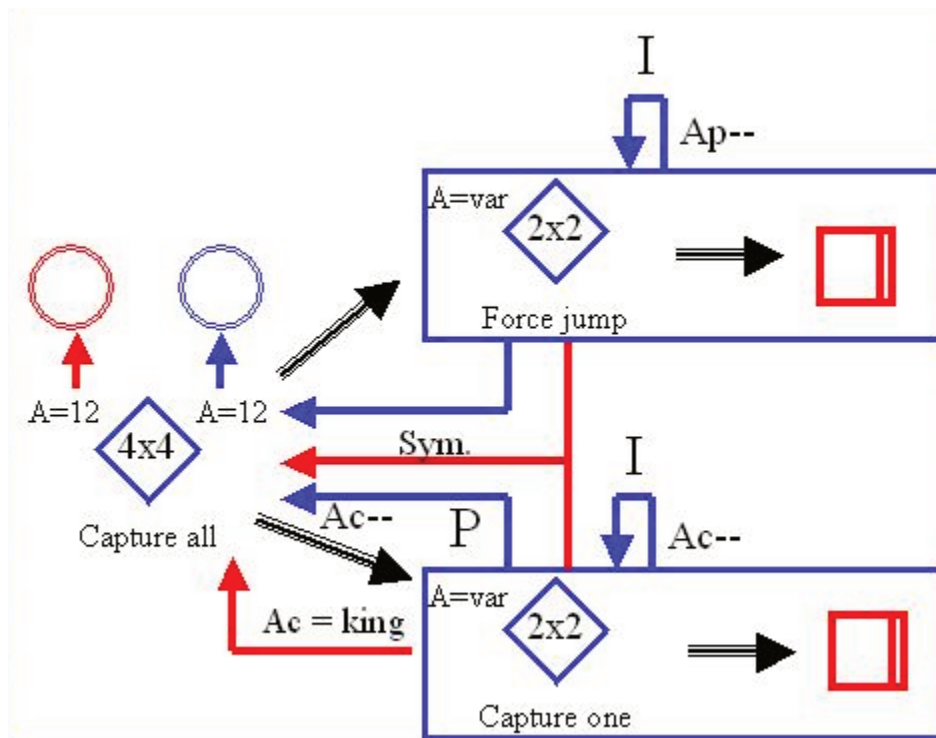

Figure 4. Raph Koster's diagram of Checkers (Koster, 2005).

Inspired by Raph Koster, Stéphane Bura (2006) takes the idea of creating game diagrams one step further. Combining Koster's approach with his experience with Petri nets, Bura designs game diagrams that try to capture a game's structure at a higher level of abstraction than simply its core rules. Removing game diagrams from the burden of modeling rules at the lowest level, allows Bura to focus more on the emergent properties of games. His diagram models notions such as *skill* and *luck* as abstract resources that affect other actions in the diagram, either by enabling or inhibiting them. Figure 5 shows the diagram Bura created to model *Blackjack*. As should become clear from this diagram, Bura tries to capture the entire gestalt of the game into a single image. In this diagram the elements that model *skill*, *luck* and *money* are similar to places in a Petri net and can accumulate tokens. The elements *gain* and *risk* act like transitions. They consume and produce resources according to the arrows that connect them to other arrows. This diagram also includes two inhibiting connections (lines that end in a circle) to denote that the *luck* of the house inhibits the *gain* of the player and that the *skill* of the player inhibits the money he or she risks. Although Bura is more optimistic than Koster, he also admits that much work still needs to be done. He suggests a standard library of ludemes to work with and sub-diagrams to increase the detail. But to our knowledge, none of these extensions have been published.

There are also a few examples of the use of UML for representing game systems diagrammatically. Taylor, Gresty and Baskett (2006) extend UML use-case diagrams to describe game-flow: the experience of the player. Their focus is on the play session and the progression of the player through the game. Perdita Stevens and Rob Pooley use class diagrams, collaboration diagrams and state machines diagrams (three different types of UML diagrams) in their educational case study of modeling the structure of *Chess* and *Tic-Tac-Toe* with standard UML (Stevens and Pooley, 1999,

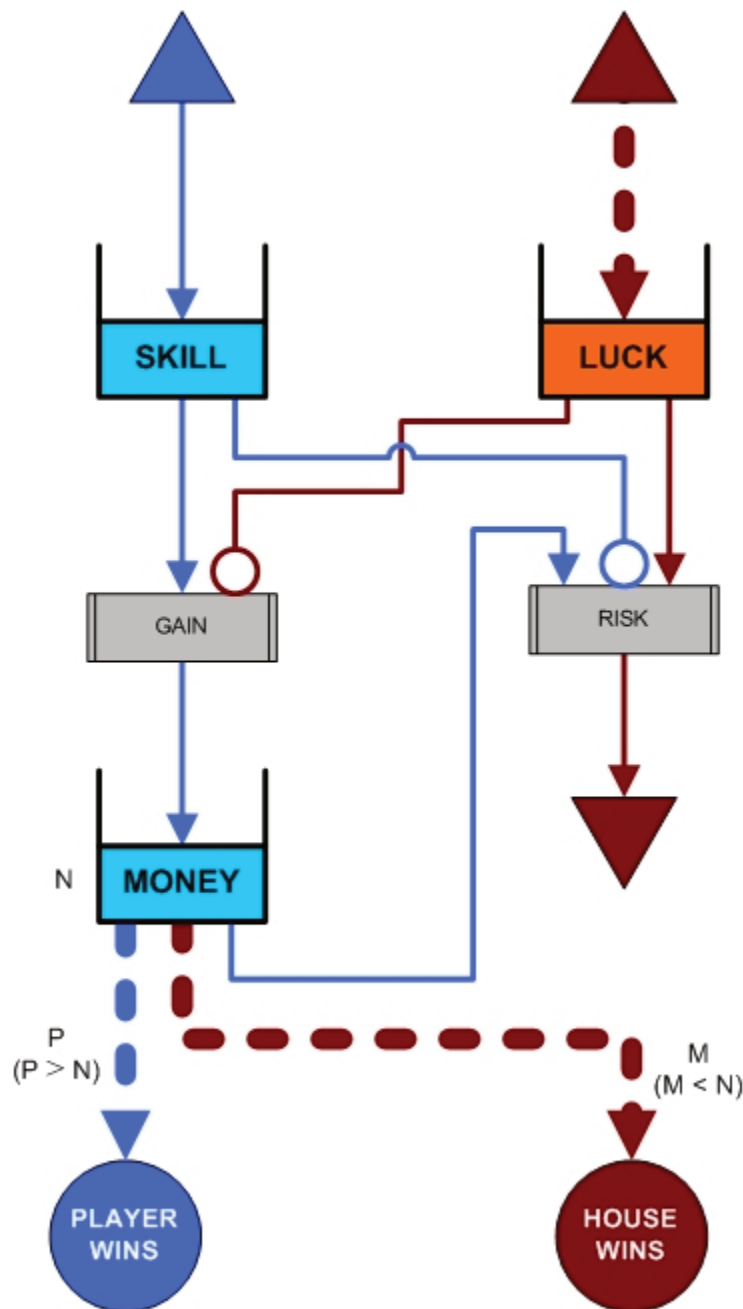

Figure 5. Stéphane Bura's diagram of Blackjack (Bura, 2006).

pp.178–189). These attempts suffer from problems similar to other types of game diagrams. As a specification language, UML can be very detailed and inaccessible to non-programmers. In a way, UML is too universal to capture the particular structures that are important in the domain of games.

MACHINATIONS

One of the most elaborate game diagram frameworks to date is *machinations*. The framework focusses on a particular aspect of game design: internal economies. The notion of an internal economy is posited by Adams (2007) and describes how many emergent behavior in games can be attributed to the flow of resources through a game. These resources can be literally economic resources such as

money, fuel, and physical items, but the notion is also applied to more abstract resources such as health, strategic advantage, or skill access on a character sheet. Initially devised by Dormans (2009; 2012) as part of his PhD research, it was later expanded by Adams and Dormans (2012) into an advanced game design text book.

The machinations framework consists of a diagrammatic language, a tool to create and execute those diagrams, and a pattern library that records common structures found across several internal economies. The diagrams themselves show how resources flow between different game elements. Game elements are represented by *pools* where resources can be *gathered* (circles), *sources* where resources flow into the game (upward triangles), *drains* where resources are removed from a game (downward triangles), and *converters* where resources are converted from one type to another (sideways triangles). The resources themselves are represented by colored tokens that can move through the diagram (not unlike a Petri net). Machinations diagrams have two types of connections: solid *resources connections* indicate how resources might flow between game elements, while dotted *state connections* indicate how the number of resources on a pool affects other elements and connections. For example, figure 6 depicts a simplified diagram of *Monopoly* from the perspective of one player. It shows how money flows into the player's possession from passing start and collecting rent. It also indicates that money can be converted into property, which in turn increases the player's rent income. The dice symbols in this diagram indicate flows subjected to chance.

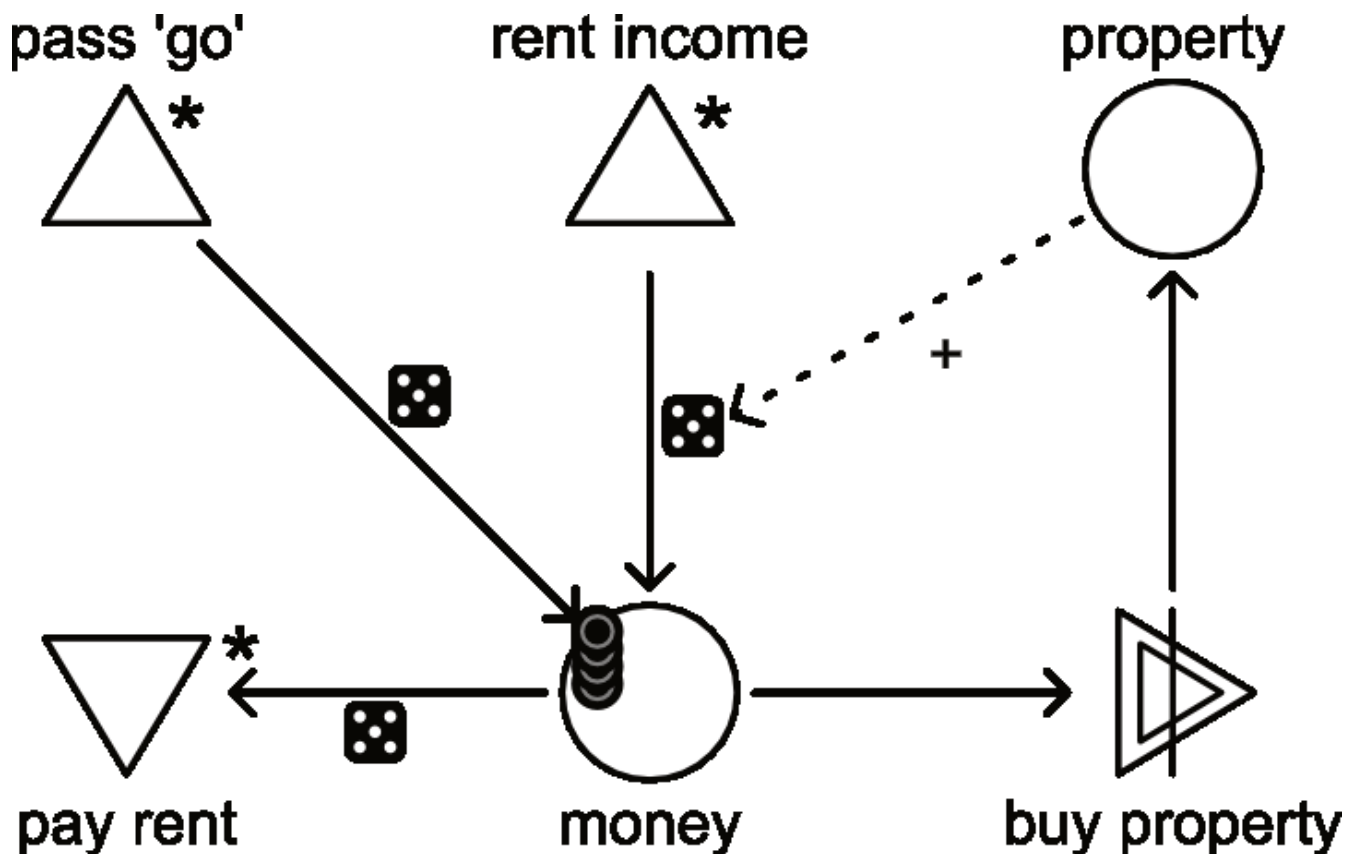

Figure 6. A Machinations diagram of Monopoly.

When drafted in the Machinations tool, Machinations diagrams can be executed. This way the dynamic behavior of the game can be observed, tested, and explored. It allows game designers to quickly test ideas, as it not always obvious how complicated diagrams will behave. A running diagram

can be fully autonomous, or the designer can design certain elements to be interactive representations of player actions. Automatic elements are marked with a star (*), whereas interactive elements have a double outline (for example the buy property converter in figure 6 above is interactive). When using the latter approach playable diagrams can be created as a prototype for the game. These playable diagrams can even be scripted to be played automatically, allowing designers to balance their games based on data collected from thousands of simulated playtests.

In a machinations diagram the state of a game is expressed as a particular distribution of resources, the diagram itself depicts the structural relations between the game elements. Most importantly, machinations diagrams were designed to foreground feedback loops within the economy, as the existence and nature of these feedback loops go a long way to explain the dynamic behavior of the games. The design patterns that are part of the machinations framework elaborate on this. They often focus on one feedback loop or the interaction between two feedback loops and discuss how that particular structure affects the game. The framework originally contained only 16 of these patterns, which combined can be used to describe and design a huge variety of games.

Although the machinations framework is fairly widespread compared to many other frameworks and design methods, its strong point, executable diagrams that can be used quickly prototype particular aspects of game design, also limits its application and creates a fairly high barrier of entry. It seems more successful as an educational framework as it brings to the foreground structural aspects of game design that are otherwise very hard to communicate. However, for experienced designers the added value is far less as they tend to be more aware of the structure of their game's internal economy. The Machinations tool might still be a good way to quickly prototype some ideas, but as the diagrams are very abstract they always fall short of being fully detailed representations of a complete internal economy.

INDUSTRY SCEPTICISM

Not everybody in the game industry thinks that developing design theory or methodology is a very good idea. In an interview with Brandon Sheffield, Raph Koster recalls that his presentation on game diagrams split his audience at the Game developers conference in 2005: "Some thought it was good, some thought it was a complete waste of time" (Sheffield, 2007). We have come across similar sentiments in discussions with people working in the game industry. Usually those who dislike the premise of design methodology argue that they are academic toys with little relevance for real game design. Another common argument against design methodology is that they can never capture the creative essence that is the heart of successful games. In this argument, design methodologies represent an attempt to destroy the very soul of the art of game design; no method can replace the creative genius of the individual designer (Guttenberg, 2006). Starting with the first, we will address both arguments below.

The current vocabularies, aids and frameworks have a poor track record. As should have become clear from the discussion above, there are many of these out there, many of them designed by academics, not all of whom have actual, hands-on game design experience. The return value of using them, set against the often considerable investment required to learn them, is not particularly high, especially for those tools that excel in analyzing games, which is done more often within universities than outside. The same goes for those frameworks that allow designers to explore the design-space. The design programs within universities allow for such exploration, whereas outside there is little time for such theoretical exploration. The argument that the industry too would benefit from such exploration

is rather hollow if money needs to be made and one cannot afford to take chances on a new innovative concept.

The sentiment is valid, but does not cripple the effort to create game design methodologies. It simply suggests criteria for evaluating design methods: design methods should help design games, not just analyze them. This seems obvious, but many methods that have been developed over the years are analytical methods, even when they sometimes are presented as design tools. These methods help us understand existing games or explore the hypothetical design space, but offer little practical guidance on how to build them. What is more, design methods should return the investment required to learn them. The latter criterion can be met in two ways: make sure that the required investment is low, or make sure that the return is high. Obviously a design method should aim to do both in order to maximize the return on investment. However, the role of methods and frameworks used in teaching game design is arguably important as they help students to view design situations and problems from different angles. There is also some evidence that different methods suit different levels of design expertise (cf. Curry, 2014). The argument that there should be an immediate return on investment in learning a new method is unconvincing when looking at the longer span of one's design career.

The second argument, that no design method can replace the creative genius of the individual designer, is more problematic. People who subscribe to this opinion dismiss the whole idea of design methodology. However, this opinion is often informed by a rather naive conception of art. Art is, and always has been, the combination of creative talent, practiced technique and hard work. There is no point in denying that one artist has more talent than another, but pure talent rarely makes up for the other two aspects. Especially within an industry where much money rides on the success of each project, investors simply cannot afford to gamble on creative talent to deliver all the time.

The image of the artist as the creative genius is a romantic vision that rarely fits reality. To create art, one must learn the techniques of the trade and work hard. This has always been the case for all forms of art. There is no reason to assume that games are any different. The artist's techniques are many. They range from the practical to the theoretical. Painters learn how to use a brush with different types of paint, on the one hand, but learn about the mathematical principles of perspective and the psychological principles of cognition on the other. Formal analysis in art, architecture, and design is thought in the universities around the world. The development of abstract art throughout the nineteenth and early twentieth century has been a gradual and deliberate intellectual process (Rosenblum, 1975). The scientific invention of the perspective revolutionized Renaissance painting (Panofsky, 1960).

The foundation of literary theory that Aristotle laid over two thousand years ago is still taught today (Hiltunen, 2002). What has changed over the years is the widening gap between artist and academic communities. During the Middle Ages art prevailed where academia hardly survived, as a result the artist and the academic frequently were the same person. These days, with thriving universities, being an academic has become a profession of its own, but that does not mean that the ties between art and academia have been severed. There are still many artists that contribute to the academic debate and there are still many academics that contribute to the evolution of art. Games are no different.

In contrast to what skeptics of design methodologies fear, design methods help shape games but they cannot replace the creative genius. No matter how good a method or tool is, it can never replace the vision of the designer, nor can it replace the hard work involved in designing a game. At best it can ease the burden and refine one's techniques. Sometimes methods and tools seem restrictive;

when holding a hammer everything starts to look like a nail. But the best methods do not restrict a designer's vision. Rather, they should enhance it, enabling them to work faster and create better results. Ideally, design methods also facilitate teamwork and collaboration. For example, a design tool that allows accurate representation of game elements would reduce the chance that individual team members end up working toward different visions.

Game designers that take no interest in design methodology are either naive or lazy. However, designers have all rights to be critical of design methods, and we do hope they remain so in the future. After all, they are the final judges that decide whether or not a given method is worth their time and ultimately expand their expressive power with the medium of games. In that respect, design research has an important task cut out for it: design methods must be evaluated. Through the evaluation of existing methods and especially through development of new methods we can increase our understanding of various and varied design practices. That way design research can convince critical designers that different methodologies can be used to create better designs and provide new perspectives to solving design problems in novel ways. Additionally, the importance of design methodologies in teaching design is well established (Curry, 2014; cf. Lawson and Dorst, 2009). It is not only the current designers in the game industry who would benefit from game design research, but the next generations of designers as well.

CONCLUSIONS

To summarize, over the years a number of frameworks, vocabularies and work methods have been created to assist game designers, with varying success. Game design documents are generally considered cumbersome and inefficient; they are seldom put to good use. Everybody uses game design documents in their own way. For some designers, these documents capture the creative direction early in the development process, while for others they are a tedious requirement of the job of game designer. For the purpose of the discussion here, no generic wisdom to aid the development of design tools can be extracted from the diffuse practice of writing design documents.

The MDA framework provides a useful lens on the different aspects of game design, and can help designers to understand where to start the huge task of designing a game. It breaks down games into three understandable and useful layers, and teaches inexperienced designers to look through the outer layers of a game into the mechanics core. However, the framework has evolved little over the years, and close examination of its core concepts is likely to raise more questions than it answers. To serve as a design tool that goes beyond the very basics of game design; the MDA framework lacks scrutiny and accuracy.

Player-centric design practices, where short iterations and frequent play-testing are the key, are more successful in structuring the hard and laborious process of designing games. However, there is room for improvement. With the proper methods and tools every iteration can be made more effective, and new ways of gathering qualitative and quantitative data might present themselves. The theories and tools presented in this chapter are best embedded within in play-centric design process: they can help designers to improve every iteration but they cannot take away the necessity to build prototypes and test them with real players.

There have been a number of attempts to create game vocabularies and pattern libraries that allow us to talk about games in better, more accurate terms. However, none of these vocabularies has really gained enough momentum to become something resembling a standard that spans both industry and

academia. From a pragmatic point of view, these vocabularies require a considerable effort to learn while they are most successful in the analysis of existing games; they seem to be more useful for academics than they are for developers. In addition, they usually lack a clear theoretical vision on the artifacts they intend to describe. The result is that these vocabularies hardly scratch the surface of games and fail to contribute much to what most designers already knew intuitively.

The use of finite state machine diagrams or Petri nets to map games as state machines are both valuable techniques with a proven track record in their respective domains. However, their respective difficulties in capturing the essence of games indicates that simply framing games as state machines is not good enough. The number of game states usually is not finite, and their complexity quickly becomes problematic if one tries to model a game in every detail. A theoretic perspective on games first needs to develop a concise and objective notion of quality in games before it can help us understand their inner machinations from a more generic scope. Once this notion has been developed, a diagrammatic language can be devised to represent these machinations. Petri nets are more promising but are less accessible to designers.

Game specific diagrams are a relatively unexplored approach towards the development of game design tools. Apart from some preliminary attempts by Koster (2005), Bura (2006), McGuire and Jenkins (2009), and Dormans and Adams (2012), little is done in this area. None of these attempts can claim to be successful and accepted by the game development community. Yet, the results are interesting, especially if they focus on a more abstract gestalt of games. A more abstract and generic scope to represent game designs seems to come quite natural to diagrams. At the same time, they are fairly easy and intuitive to learn: most diagrammatic languages utilize only a few core, reusable elements. When these elements express a generic and objective notion of quality in games, these diagrams could become quite powerful.

Game design tools are needed; they can be used to improve the process of game design, but the poor track record of current academic approaches created some resistance within the game industry against the whole notion of design methodology. Part of this resistance is understandable, as methods frequently fail to return the investment required to use them. This means that we need to rethink how design methods and tools should be used: they should not only facilitate analysis or theoretic exploration of game concepts, rather they should really help the designer to design. We should also take note of the fact that game design methods cannot replace the creative talent of the individual game designer. Game design methods should refine a designer's technique and increase the designer's expressive power; any game design method should ultimately be a tool, but it remains up to designer to make those tools work.

BIBLIOGRAPHY

Adams, E. and Dormans, J., 2012. *Game mechanics: advanced game design*. New Riders.

Adams, E. and Rollings, A., 2007. *Fundamentals of game design*. Pearson Prentice Hall.

Alexander, C., 1979. *The timeless way of building*. Oxford University Press.

Alexander, C., Ishikawa, S., Silverstein, M., Jacobson, M., Fiksdahl-King, I. and Angel, S., 1977. *A Pattern language: Towns—buildings—construction*. Oxford University Press.

- Araújo, M. and Roque, L., 2009. Modeling games with Petri nets. In: Proceedings of the 2009 DiGRA international conference: Breaking new ground: Innovation in games, play, practice and theory. [online] Brunel University.
- Binmore, K., 2007. *Game theory: A very short introduction*. Oxford University Press.
- Björk, S. and Holopainen, J., 2005. *Patterns in game design*. Charles River Media.
- Brom, C. and Abonyi, A., 2006. Petri-nets for game plot. In: *Proceedings of AISB '06: Adaptation in artificial and biological systems*. Bristol UK, April 2006, pp.6–13.
- Bura, S., 2006. A game grammar. Available at: <<http://www.stephanebura.com/diagrams/>>
- Church, D., 1999. Formal abstract design Tools. *Gamasutra*. Available at: <http://www.gamasutra.com/features/19990716/design_tools_01.htm>.
- Cook, D., 2006. GameInnovation.org. Blog post on *LostGarden*. Available at: <<http://www.lostgarden.com/2006/04/gameinnovationorg.html>>.
- Costikyan, G., 1994. I have no words & I must design. *Interactive Fantasy: The Journal of Role-playing and Story-making Systems*, 2.
- Costikyan, G., 2002. I have no words & I must design: Toward a critical vocabulary for games. In: F. Mäyrä, ed. 2002. *CGDC conference proceedings*. University of Tampere Press. Available at: <<http://www.digra.org/digital-library/publications/i-have-no-words-i-must-design-toward-a-critical-vocabulary-for-games/>>
- Cross, N. and Roy, R., 1989. *Engineering design methods*. Wiley.
- Curry, T., 2014. A theoretical basis for recommending the use of design methodologies as teaching strategies in the design studio. *Design Studies*. DOI=10.1016/j.destud.2014.04.003.
- Dormans, J., 2008. Visualizing game mechanics and emergent gameplay. In: *Proceedings of the meaningful play conference*. East Lansing MI, October 2008.
- Falstein, N., 2002. Better by design: The 400 project. *Game Developer Magazine*, 9(3), p.26.
- Fowler, M., 2004. *UML distilled: A brief guide to the standard object modeling language*. 3rd ed. Addison-Wesley.
- Fullerton, T., Chen, J., Santiago, K., Nelson, E., Diamante, V., Meyers, A., Song, G. and DeWeese, J., 2006. That cloud game: dreaming (and doing) innovative game design. In: *Proceedings of the 2006 ACM SIGGRAPH symposium on videogames—Sandbox '06*. ACM Press, New York, New York, USA, pp.51–59. DOI=10.1145/1183316.1183324.
- Gamma, E., Helm, R., Johnson, R. and Vlissides, J., 1995. *Design patterns: Elements of reusable object-oriented software*. AddisonWesley.
- Grünvogel, S.M., 2005. Formal Models and Game Design. *Game Studies*, 5(1). Available at: <<http://gamestudies.org/0501/gruenvogel>>.

Guardiola, E., and Natkin, S., 2005. Game theory and video game, A new approach of game theory to analyze and conceive game systems. In: *Proceedings of the 7th international conference on computer games*. Angoulême, France, November 2005 .

Guttenberg, D., 2006. An academic approach to game design: Is it worth it? *Gamasutra*. Available at: <http://www.gamasutra.com/view/news/8908/Student_Feature_An_Academic_Approach_to_Game_Design_Is_It_Worth_It.php>.

Hunicke, R., Leblanc, M. and Zubek, R., 2004. MDA: A formal approach to game design and game research. In: *Proceedings of the AAAI-04 workshop on challenges*. pp.1–5.

Isbister, K. and Schaffer, N., 2015. *Game usability: Advancing the player experience*. CRC Press.

Johnson, S., 2005. *Everything bad is good for you*. Allen Lane.

Järvinen, A., 2003. Making and breaking games: A typology of rules. In: M. Copier and J. Raessens, eds. 2003. *Level up conference proceedings: Proceedings of the 2003 digital games research association conference*, Utrecht The Netherlands, November 2003, pp. 68–79.

Hiltunen, A., 2002. *Aristotle in Hollywood: Visual stories that work*. Intellect.

Keith, C., 2010. *Agile game development with Scrum*. Addison-Wesley.

Koster, R., 2005. A Grammar of Gameplay: game atoms: can games be diagrammed? Presentation at the *Game developers conference*, San Francisco CA, March 2005. Available at: <<http://www.raphkoster.com/gaming/atof/grammarofgameplay.pdf>>

Klabbers, J.H.G., 2003. Gaming and simulation: Principles of a science of design. *Simulation & Gaming*, 34(4), pp.569–591.

Kreimeier, B., 2002. The case for design patterns. *Gamasutra*. Available at: <http://www.gamasutra.com/view/feature/132649/the_case_for_game_design_patterns.php>.

Kreimeier, B., 2003. Game design methods: A 2003 survey. *Gamasutra*. Available at: <http://www.gamasutra.com/view/feature/2892/game_design_methods_a_2003_survey.php>.

Larman, C. and Basili, V.R., 2003. Iterative and incremental developments. a brief history. *Computer*, 36(6), pp.47–56.

Lawson, B. and Dorst, K., 2009. *Design expertise*. Elsevier.

Leblanc, M., 2004. Mechanics, dynamics, aesthetics: A Formal approach to game design. Lecture at Northwestern University. Available at: <<http://algorithmancy.8kindsoffun.com/MDAnwu.ppt>>.

Leblanc, M., 2005. Tools for creating dramatic game dynamics. In: K. Salen and E. Zimmerman, eds. *The game design reader: A rules of play anthology*. MIT Press, pp.438–459.

Librande, S., 2010. One-page designs. GDC presentation. Available at: <<http://www.gdcvault.com/play/1012356/One-Page>> [accessed 19.4.2017].

- Liukkonen, T.N., Heimo, O.I., Mäkilä, T. and Smed, J., 2015. Comparative analysis on game design pattern collections. In: *GAMEON—AI and simulation in games conference*. Amsterdam, The Netherlands.
- Lindley, C., 2003. Game taxonomies: A high level framework for game analysis and design. *Gamasutra*. Available at: <http://www.gamasutra.com/view/feature/2796/game_taxonomies_a_high_level_.php>
- Lindley, C.A. and Sennersten, C.C., 2008. An innovation-oriented game design meta-model integrating industry, research and artistic design practices. In: O. Leino, H. Wirman and A. Fernandez, eds. 2008. *Extending experiences. structures, analysis and design of computer game player experiences*. Lapland University Press, pp. 250–271.
- McGuire, M. and Jenkins, O.C., 2009. *Creating games: mechanics, content, and technology*. A.K. Peters, Ltd.
- Natkin, S. and Vega, L., 2003. Petri Net modeling for the analysis of the ordering of actions in computer games. In: *Proceedings of GAME-ON conference*, London UK, November 2003, pp.82–92.
- Pagulayan, R.J., Keeker, K., Wixon, D., Romero, R.L. and Fuller, T., 2003. User-centered design in games. In: J.A. Jacko and A. Sears, eds. 2003. *The human-computer interaction handbook: Fundamentals, evolving technologies and emerging applications*. Lawrence Erlbaum Associates, Inc., pp.883–906.
- Panofsky, E., 1960. *Renaissance and Renascences in Western art*. Almqvist & Wiksell.
- Rogers, S., 2010. *Level up! : The guide to great video game design*. Wiley.
- Rosenblum, R., 1975. *Modern painting and the Northern romantic tradition, Friedrich to Rothko*. Thames and Hudson Ltd.
- Salen, K. and Eric, Z., 2003. *Rules of play: Game design fundamentals*. The MIT Press.
- Seif El-Nasr, M., Drachen, A. and Canossa, A. eds. 2013. *Game analytics*. Springer London. DOI=10.1007/978-1-4471-4769-5.
- Schaffer, N., 2008. Heuristic evaluation of games. In: K. Isbister and N. Schaffer, eds. 2008. *Game usability: Advice from the experts for advancing the player experience*. Morgan Kaufman Publishers, pp.78–89.
- Selic, B. and Rumbaugh, J., 1998. Using UML for modeling complex real-time systems. 2008. Available at: <http://www.ibm.com/developerworks/rational/library/content/03July/1000/1155/1155_umlmodeling.pdf>.
- Sheffield, B., 2007. Defining games: Raph Koster's game grammar. *Gamasutra*. Available at: <http://www.gamasutra.com/view/feature/1979/defining_games_raph_kosters_game_.php>.
- Stevens, P. and Pooley, R., 1999. *Using UML: Software engineering with objects and components*, updated edition. Harlow, UK: Addison Wesley Longman Ltd.
- Sweetser, P. and Wyeth, P., 2005. GameFlow: A model for evaluating player enjoyment in games. *Computers in Entertainment*, 3(3). DOI=10.1145/1077246.1077253.

Taylor, M.J., Gresty, D. and Baskett, M., 2006. Computer game-flow design. *Computers in Entertainment*, 4(1).

Walk, W., Görlich, D., and Barrett, M., 2017. Design, Dynamics, Experience (DDE): An advancement of the MDA framework for game design. In: O. Korn and N. Lee, eds. *Game dynamics: Best practices in procedural and dynamic game content generation*. Springer International Publishing.

Zagal, J.P., Mateas, M., Fernández-Vara, C., Hochhalter, B. and Lichti, N., 2005. Towards an ontological language for game analysis. In: *Changing views: Worlds in play: Proceedings of the 2009 digital games research association conference*, Vancouver Canada, June 2005.

CHAPTER 5

GAMES DESIGN RESEARCH THROUGH GAME DESIGN PRACTICE

PAUL COULTON AND ALAN HOOK

Whilst many game design academics are also game designers, their research is often presented through the lens of other disciplines (philosophy, media theory, human computer interaction [HCI], etc.) and practice-based design research is arguably underrepresented in the games research community. Although game design research espouses to open an inclusive community, at present, research approaches and the presentation of results is dominated by those inherited from either the social sciences or HCI (Deterding, 2016). This dominance of loaded and prescriptive academic frameworks is arguably why many of those creating games outside academia feel such research is unrepresentative of their own practices. In many respects this tension in game design, between research and practice, mirrors what happened in the broader discipline of design whereby academic research was often perceived as separate from design practice (cf. Frayling, 1993). More recently practice-based research has been the subject of increased interest, particularly within HCI (Gaver, 2012) and media studies, coinciding with an increasingly prominent role given to design by the UK Research Council; both as a distinct area of practice-based research and the benefits of its inclusion within interdisciplinary research projects. This also correlates with feedback from Research Assessment Framework panels (periodic review or research performance at UK) universities which praised the value of practice-based or non-textual research outputs for its impact on communities and cultures outside of the education sector (Sutherland and Acord, 2007).

This then leads us to question why is game design research not more readily engaging with the broader design research community? This is particularly important as game design research could also offer insights for design research more generally. Although it has been proposed that adopting a design science approach could address game design through practice (Waern and Back, 2015), drawing on a similar proposition by Herbert Simon (1981) for design, it is important to note that this HCI desire for technological rationality has largely been rejected by design researchers in favor of “design studied on its own terms, and within its own rigorous culture” (Cross, 2001). The aim of this chapter is therefore to draw from approaches used for practice-based research in design that successfully produce what is accepted as valid forms of academic design research so that areas of game design research can move closer to reflect game design practice, mirroring its acceptance in the wider design disciplines. By situating research through game design amid the wider discourses of practice-based research we can consider new approaches to game design research in the context of the broader discipline of design rather than through other academic disciplinary lenses.

To start such a consideration, it is important to gain a methodological understanding of how research through game design could be undertaken by drawing upon methodological approaches that are

considered commensurate with design practice. The chapter will then focus on game design practice that is primarily concerned with the construction of the communicative rather than purely as objects of entertainment, that is, games whose design is primarily to question societal values and norms. The choice of such games is primarily due to the parallels with practices in design research outside of games and provides a useful illustration of the benefits of situating games within more general design theory and discourse. In games research such approaches would primarily be considered as part of *critical play* (Flanagan, 2009), while in design more generally such approaches are considered within *radical design*, *critical design*, *speculative design*, and *design fiction* (Coulton, Burnett and Gradinar, 2016). We therefore situate game design practice within this wider critical research discourse to help illuminate ways game design could grow as a form of research, building on a long history of *research through design* (RtD) practice. We would note that parts of this discussion is a reflection on our own practice as game designers and as academics within art and design and should not therefore be considered a prescriptive model for how such research is undertaken.

For researchers situated in academic disciplines outside art and design this chapter may be both challenging and controversial in that it likely diverges from the practice of research within those disciplines. However, we believe it is important for game design research to emulate the success of RtD practice more generally by not becoming entrenched in a narrow set of research approaches or frameworks and to open up a debate as to whether a wider range of representations of research is needed to fully encompass game design research.

TOWARDS A THEORY OF PRACTICE

To start our methodological exploration, we must position practice-based research with respect to what is considered valid knowledge and then what research methods best suit the acquisition or production of such knowledge. Typically design research starts with open-ended research aims or open research questions, rather than a specific hypothesis to be tested. This is a deliberate choice as designers often describe their practice as “problem framing rather than problem solving” (Schön, 1983) and is a practice that requires reflection, leading to an emergence of understanding throughout the design process. This contrasts greatly with the more traditional positivist methodologies used by many researchers considering games; which place most value on quantifiable outcomes (Nacke, et al., 2009). This is not to say that a positivist approach is wrong, it is just that it is primarily aimed towards fixity, reduction, singularity, and defined outcomes; which is not the only way academic research can be undertaken. It is this reflective practitioner (Schön, 1983) approach that is often seen as the most significant factor in design’s ability to address the complex societal and environmental challenges we now collectively face, the so-called *wicked problems* which was originally proposed by Horst Rittel (1972) in relation to urban planning but popularized in relation to design thinking (Dorst, 2011) by Richard Buchanan (1992). This approach is sometimes ambiguously referred to as a *designerly* way of thinking and acting (Cross, 2001; Buxton, 2007; Moggridge, 2007). Further, this is often seen as a way that designers are able to deal with the complexity or messiness of the real world situations they are primarily engaged with. To quote the sociologist John Law:

If this [something] is an awful mess [...] then would something less messy make a mess of describing it? [...] Simplicity [...] won’t help us to understand mess (Law, 2007)

His discussion is centered on a comparison of contemporary positivist approaches which utilize sciences’ techniques that favor clarity, specificity and repeatability at the cost of repressing the mess. Mess, according to Law is almost the opposite of intellectual hygiene—by this he means

that everything that is typically removed in order to perform unbiased lab-based research can be considered as mess. He argues that this mess makes up a very large portion of the world we inhabit, and as a result mess is highly relevant to the research both in terms of understanding the limitations of the data, and that it encourages the iterative (re)defining of the question that the research is trying to answer in response to the mess. As games are predominantly designed to be played in the real world, in complex social situations, it seems appropriate therefore that some approaches to game design research are able to embrace the mess of non-laboratory based research, and practice-based design research is arguably well equipped to meet this aim. This notion of embracing the mess was also promoted by Ian Bogost in his 2009 DiGRA keynote speech:

Videogames are a mess. A mess we don't need to keep trying to clean up, if it were even possible to do so.
(Bogost, 2009)

Bogost (2009) was also proposing the adoption of Law's perspective and sought to encourage game studies academics of all persuasions to resist the desire to make the study of videogames tidy, which he said leads to unnecessary polarization as exemplified in the ludology–narratology debates.

GAME RESEARCH THROUGH GAME DESIGN

To consider the question of what practice-based game design research could be; we address it from within the context of Frayling's description of research within art and design (Frayling, 1993) which begins by making the distinction between research (big 'R') and research (small 'r'). The former Frayling equates to the production of new knowledge, whereas the latter is the utilization of pre-existing knowledge within a design activity (1993). This offers researchers a framework to discuss their activities and a distinction between both the intent and outcomes of the activities. To emphasize the problems of understanding the research within design practice, Frayling (1993) highlights how stereotypical views of artists, designers, and scientists often suggests a clear distinction between these activities, when in fact they are deeply intertwined; "Research is a practice, writing is a practice, doing science is a practice, doing design is a practice, making art is a practice". Frayling's overall conclusion is that amongst these practices there is a lot of common ground but "there is also a lot of private territory". In concluding the discussion Frayling introduces three characterizations of design research as: *research about design*, *research through design*, and *research for design*, which can be considered as follows (Frankel and Racine, 2010):

- *Research about design*: Research focused on the experience of designers and those who use their products i.e. design activity, design behavior and design cognition.
- *Research through design*: The emphasis here is on creating design knowledge and not the project solution; through an action-reflection approach. It seeks to provide an explanation or theory within a broader context: for example, research in emerging fields of design.
- *Research for design*: Research to enable design where the end product is an artifact, where the thinking is embodied in the artifact.

Although RtD and research for design are characterized separately, they are invariably linked within the same artifact (Kroes, 2002) and of the three they are "the closest to the actual design practice" (Godin and Zahedi, 2014). However, of these two only RtD is considered by Frayling as producing big R research and therefore, with this applicability to practice, leads us to the conclusion that RtD is highly suitable form of academic research for games. Particularly as game researchers are a community that seeks to actively engage with its commercial design counterpart. The artifacts or

systems, which are a product of an RtD approach, can be considered as a form of situated knowledge (Suchman, 1987) in that they are bound within a particular instance of design. However, the majority of game design research up to now would be categorized as research about design and would include a significant proportion of HCI related research. Whilst RtD is being adopted within the HCI community it is proving highly contentious between those who simply conflate it with making and wish to create generalizable models and frameworks (Zimmerman, Forlizzi and Evenson, 2007) and others who wish to maintain its original focus of reflection on process and reject that generalization is applicable or even desirable for design practice (Gaver, 2012). This contention is perhaps analogous with previous discussion in relation to Law's consideration of mess and that there are very different methodologies used within science and design. Whereas sciences' methodologies typically concentrate on the outcomes of the scientific research processes, such as empirical claims, laws, and theories, Nigel Cross characterizes design methodology as "the study of principles, practices and procedures of design" (Cross, 1993) which aims to improve design practice and is strongly process oriented (Kroes, 2002). Therefore, we further argue that whilst HCI research practices have an important role within games research there should also be a place for game design research that provides reflection on the processes of design.

TOWARDS AN EPISTEMOLOGY OF GAME DESIGN AS PRACTICE

One of the primary difficulties with, and criticisms of, RtD is that the experience and subjectiveness of the designer/researcher often plays a significant role within the research. This can lead to both the process and artifacts of designing being affected by the culture of, and the tacit knowledge held by, the designer throughout the creative process. A gamut of choices goes into the design of any given artifact that may include: the functionality of the design, its aesthetics, the practicalities of production, the motivation for making, the identities and capabilities of the people for whom the artifact is intended (Gaver and Bowers, 2012). How then do researchers make a case that knowledge generated through such a design process is valid knowledge? To answer this, they must consider their epistemological position as researchers. Whilst this will vary dependent on the individual researcher, here we present a position that is commensurate with our discussions relating to researching through a game design practice.

An influence from the postmodern

Postmodernism is not only used to describe a period but also a set of ideas that can only really be understood in relation to the equally difficult to define modernism. Modernism was a diverse art and cultural movement in the late 19th and early 20th centuries that sought a break from previous ways of doing things. Postmodernism can be considered as questioning the ideas and values associated with a form of modernism that believes in progress and innovation. Whilst a full discussion of this topic and its influence on design and research is beyond the scope of this chapter here we are simply acknowledging that this influence is present within academic thinking and in particular two aspects that are relevant to our subsequent discussions. Firstly, whereas modernist approaches often rely on a single consideration of knowledge production, such as empirical evidence, post-modernism advocates epistemological pluralism, which inherently supports multiple ways of considering the production of knowledge (Rodríguez Ramírez, 2009). In particular, this means stories become the important element of postmodern research and these stories are not only about the people being researched, but also from the own experience and cultural background of the researcher. Many design practices place an emphasis on the role of stories (Erickson, 1996) and thus if game design research is to more closely align with game design practice this would suggest it should take a turn

towards facilitating research outputs that actively encourage the inclusion of designers' reflections on a particular design process. Secondly, postmodernism is often associated with adopting and then pastiching existing cultural forms (Jameson, 1985) or adopting critical perspectives particularly in relation to cultural identity (Mukherjee, 2016). The appropriation of particular forms and tropes is an attribute of the critical and speculative design practices we will consider later in this chapter and thus exhibits postmodern tendencies.

Constructivism

Design research is tied to a domain that derives its creative energy from the ambiguities of an intuitive understanding of phenomena (Swann, 2002).

Phenomenology suggests that all mental phenomena are about something, from which it can be argued that the subjective thought of the designer cannot be separated from the object of thought, i.e. the designed artifact, even though they are two different entities. A view of the world in which subjective thought and the object of that thought are coupled is constructivism. Constructivism focuses on the "meaning-making activity of the individual mind" within which the worldview of one individual is as valid as any other individual, including the designer or researcher (Rodríguez Ramírez, 2009). This means that while valid knowledge can be produced, acknowledging the cultural background and motivations of the researcher at all stages of the research is an important means of critically assessing such research. Thus the presentation of such research requires formats that facilitate this form of assessment and it has been proposed that annotated portfolios are one such format (Gaver and Bowers, 2012). An annotated portfolio brings together a collection of individual artifacts within a single body of work and serves to highlight the similarities and differences in this family of artifacts. Annotations can be text, images, and doodles reflecting different purposes, interests, with different audiences and contexts, and the annotations and artifacts exist in a symbiotic relationship mutually informing each other: "Artifacts are illuminated by annotations. Annotations are illustrated by artifacts" (Gaver and Bowers, 2012). Whilst annotated portfolios are common within art and design departments, and have been proposed for HCI (Bowers, 2012), they do not readily adapt to the rigid formatting prescribed by many conferences proceedings or journals. Such structures could thus be considered as examples of what John Law (2014) describes as "method assemblages" which can restrict or curtail the production of knowledge to a limited number of approaches. Therefore, games research, and other areas approaching design research, need to consider whether they need to be more open and accepting of different forms for the presentation of research.

Grounded approaches

Grounded approaches derive their inspiration from *grounded theory* methodology through which theory is derived as a result of the research and is not the precursor to it. "Theory evolves during actual research, and it does this through continuous interplay between analysis and data collection." (Strauss and Corbin, 1990). A typical approach to applying grounded theory in practice would involve a researcher gathering qualitative data, often in the form of interviews or personal observations. This data is then analyzed through techniques such as coding in which the researchers seek to identify concepts and theoretical explanations for phenomenon (Strauss and Corbin, 1990).

Strauss and Corbin say that this approach is most suitable when "all of the concepts pertaining to a given phenomenon have not been identified, or are not fully developed, or are poorly understood

and further exploration on a topic is necessary to increase understanding” (1990). Whilst this suggests that grounded theory responds to the mess previously highlighted, Mol and Law (2002) have argued that it is still inherently positivist as it seeks to create a reductionist explanation of reality and asked “how might complexities be handled in knowledge practices non-reductively, but without at the same time generating even more complexities until we submerge into chaos?”. It was Adele Clarke (2005) who sought to answer this question by taking a postmodern turn with grounded theory by moving it away from a social process metaphor to an “ecological root metaphor of social worlds, arenas or negotiations”.

Clarke (2005) proposed the construction of knowledge through cartographic situational analysis and in particular making three different types of maps that help visualize different relationships between participants in the situational context. Clarke (2005) suggested this also takes grounded theory away from the notion that a researcher can approach such research free from any preconceptions, highlighted by Charmaz and Mitchell (1996), as in the act of creating these maps researchers reveal themselves. This emphasis on visual representation aligns well with design practices and in particular the map-making activities seen in areas such as service design (Stickdorn, et al., 2011). Further, as the designer is the one producing the research artifacts, a postmodernist approach to grounded theory allows for this as long as they clearly state their motivations, background, and offer an in-depth description of the experience and decisions that they went through. This is again commensurate with RtD and indeed our own practice.

Much of this would also appear similar to *action research*. Action research also acknowledges the complexity of social phenomena (Swann, 2002). It also acknowledges that there is non-linearity between cause and effect, and that the best response to such mess or complexity is to reject the notion that this can be addressed by a lone researcher and to engage stakeholders into the research process. Thus action research can be viewed as an approach for carrying out participatory research in which research through game design can easily fit.

BEING ITERATIVE

There are a number of models proposed for considering design activities that occur throughout the process but here we draw upon the work of renowned interaction designer Bill Verplank (2009) and his consideration of difference between *craft* and *design* as shown in Figure 1. Unlike craft, design exhibits separate activities or modes. For example, in an ideation phase the aim is to produce many alternatives which can be evaluated through testing. In a game this might be a series of different mechanics to explore the relationship between game objects or assets. Each alternative and testing is followed by reflection in an iterative manner. Without this iteration alternatives are not considered, comparisons are never drawn, and assumptions are never challenged.

At the core of invention might be a hunch followed by a hack followed by another hunch (craft) but an idea or generalization is needed for generating alternatives, prototypes and tests (design). The goal is principles, which organize the value of a product which creates a market which creates a paradigm and we are back to a fixed orbit. Design is the “transfer orbit” that gets us out of a small orbit into a larger one. (Verplank 2009)

Design processes such as these can be considered as method assemblages (Law, 2014), which can ultimately restrict what new and situated research knowledge is created to only that which is facilitated by the method. In other words, if your research practice is through the creation of games the way you produce those games will heavily influence the knowledge produced. What is also interesting about Verplank’s (2009) diagram is that we can use it to consider different aims of research

game design and commercial games design as also shown in Figure 1. In commercial games the ultimate aim is primarily to get the game into the market in order to make a profit. As with research for design, in a commercial game the knowledge produced would be demonstrated in the final product. In research through game design our aim is to produce knowledge which comes through the iterative critical and reflective practice and is likely represented through new methods, principles, and paradigms.

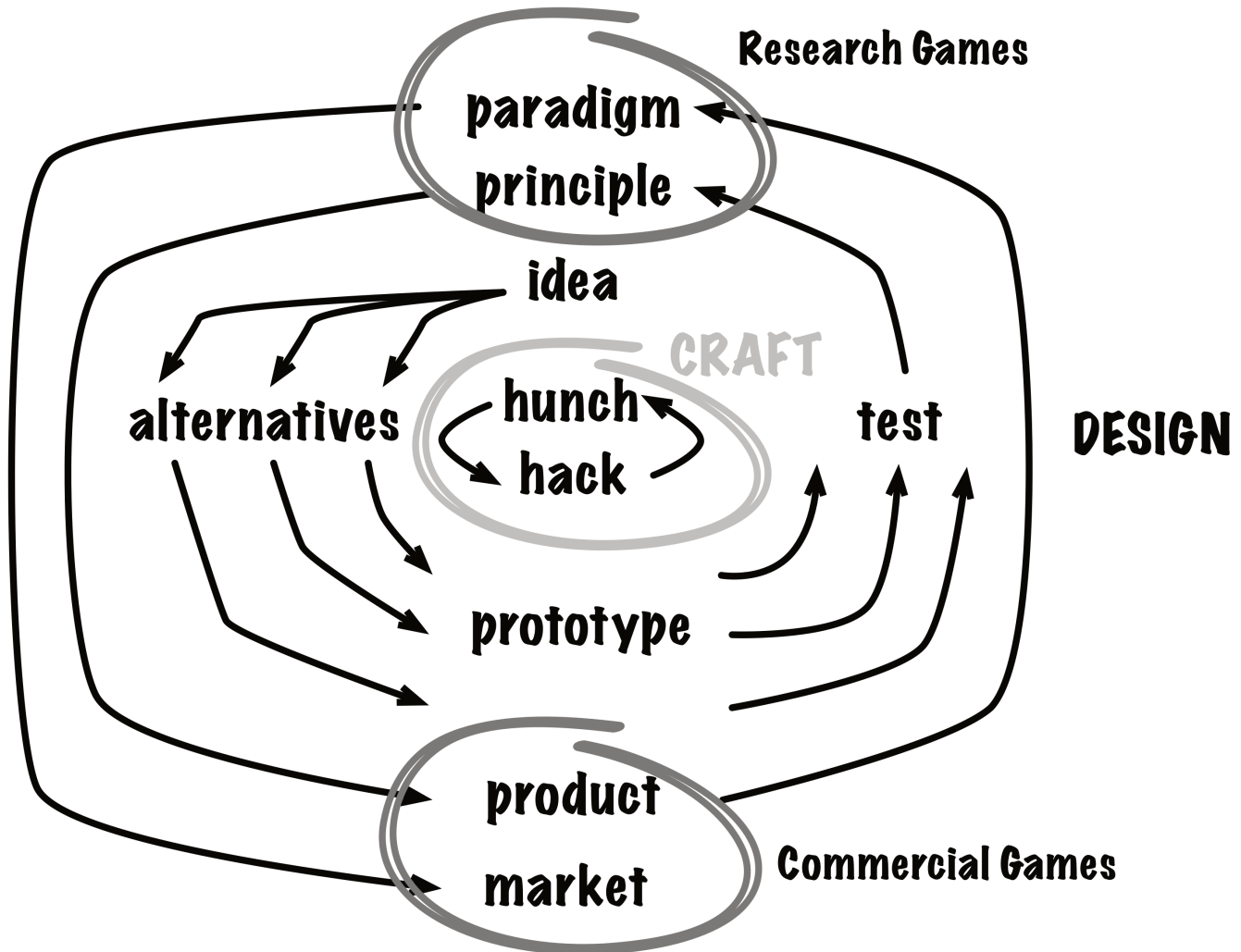

Figure 1. Design/Research Process inspired by Verplank (2009).

REFLECTING ON THEORY IN PRACTICE

In the following sections we will consider game design that goes beyond that of producing games purely for entertainment. In particular, we focus on approaches that could be considered as emerging from the so-called *art games* movement as defined by Jason Roher (cited in Bogost, 2011). This is arguably the area currently closest to practice-based research. However, we would concur with Ian Bogost that art games is an insufficient term to consider many games, and it is currently “a stand-in for a yet unnamed set of movements or styles, akin to realism or futurism” (Bogost, 2011) and by considering relevant approaches from design we may help towards developing a clearer understanding of what this may be.

CRITICAL PLAY

Mary Flanagan (2009) introduced *critical play* in relation to games as a way to understand how games, as designed systems, can work as a critical or cultural lens to reflect on social, cultural or political issues. The game acts to encourage players to think critically about the problems the game reflects upon. Thus play, as a form of interaction within the designed situation, system or framework, then works as a mode of critical enquiry into the topics that the game addresses. Games that use *critical play* to inform their development often reflect on current, or historical, political and cultural issues. However, critical play does not have the focus on critiquing possible or plausible futures as is dominant within *critical design* (Dunne, 2008), *speculative design* (Auger, 2013), and *design fiction* (Lindley and Coulton, 2015). Whilst Flanagan does not preclude such a focus for critical play, thus far the vast majority of the critical games created have primarily been either to critique current events or practices within the games industry or critique games themselves (Grace, 2015). An example of the former is Molleindustria's (2011) smart phone game *Phone Story* which critiques smart phone production by highlighting aspects such as the harvesting of precious metals and the production of electronic waste. This example is important as it utilizes the games platform to create a critical linkage between the designed object (the smartphone) on which the game is played and the critical play of which critiques the objects own ecology of production. In effect the game transforms the smartphone into a critical object and asks the players to reflect on the media and technological ecology of the device. Critical games, or games which use critical play often try to create tensions between the player objectives, the obstacles and the rule systems; to create a space for reflection by the player about the games meaning and the social or political critique it is performing. Reflecting on how a designer constructs critical play, Grace (2010, p.28) states that "critical gameplay is created by observing a set of standard assumptions, deconstructing the assumptions in that standard, and reorienting that set of assumptions through the production of an alternate model of play." This iterative approach is commensurate with the design activities previously shown in Figure 1.

Another example of critical play is Flanagan's own game, *Giant joystick* (Flanagan and Nissenbaum, 2014), which provides both a critique about the lack of collaborative play in many games, while its phallic nature also pokes fun at male dominated play and machismo within contemporary game design (Grace, 2014). In this respect, Martins' (2014) critique of privilege within speculative and critical design, cannot be so easily leveled at critical games, as the work of designers, such as Anna Anthropy (2012), directly address subjects such as race, gender, and sexuality. Through critical play, games can then also function as operational tools to reflect on and understand the self (Flanagan, 2009) and are often "orientated towards introspection over immediate gratification" (Bogost, 2011, p.14). Flanagan's engagement in both the theory building around games, and contribution to valid knowledge through the creation of RtD is important as it shows the production and consolidation of valid knowledge through both traditional and non-traditional means.

Another researcher, who writes traditional scholarly work as well as making research through game design, Stefano Gualeni (2015) builds on the work of researchers such as Flanagan by proposing games and virtual environments as a form of philosophic tool. Gualeni (2015, p.85) argues that games can open up "new and interactive horizons of thought, and of ways to understand time, space, properties, and causation that are supplementary, and in some cases even alternative, to those through which human beings structure their everyday relationships with the actual world." Games then can be a speculative practice which can help players (re)consider, critique and reflect on the present, but are also a process of world building where players can explore alternative ways of being. This approach to games is able to both challenge and build theory and could be interpreted as commensurate of viewing

games through the disciplinary lens of philosophy. For example, Gualeni's research, both his written responses and his games, create a body of work, or reflective portfolio, that situates it both within game design, and philosophy contributing new knowledge to both disciplinary fields. Thus games can engender debates about the world and open critical, speculative, and discursive spaces where the player can consider complex cultural issues through play.

CRITICAL DESIGN, SPECULATIVE DESIGN, AND DESIGN FICTION

Whilst there is no commonly agreed definition of speculative design, critical design, or design fiction they arguably share certain similarities in that they: remove the commercial constraints that might normally limit the design process, uncoupling the methodologies from commercial discourses; use prototypes as the main method of enquiry; and use fiction to present alternative realities (Auger, 2013). As such they are indicative of a more general shift from design no longer principally focusing on technological problem solving but instead to the cultural and the construction of the communicative (Arnall and Martinussen, 2010; Balsamo, 2011). Thus, whilst design research can aid technological innovation it can also involve the creation of expressions of cultural understandings, including narratives, myths, values, and representations (Martinussen, Knutsen, and Arnall, 2014). An early example from the commercial design world is *Futurama*, created by Norman Bel Geddes, and sponsored by General Motors (GM) for the World's Fair of 1939. *Futurama* transported visitors over a huge diorama of a fictional section of the United States, and is widely credited as introducing the American public to the concept of networked expressways connecting the nation. *Futurama* painted a picture of the world 20 years into the future. It set an agenda and significantly influenced transportation and planning policy. By providing a glimpse of an unknown-yet-desirable future the exhibit influenced how a nation saw their world in relation to the product that ultimately came to define the USA: the car. GM did not promote a possible design for a car, but rather they prototyped a fictional future world that endorsed the notion that cars would become an integral element in American society and culture. Another example of such fictional prototyping in the commercial world is vaporware—a term commonly used to describe software and hardware that is announced, sometimes marketed, but is never actually produced (Atkinson, 2013). It is worth noting that although it pervades many areas of technology, the games industry is one that seems particularly prone to producing vaporware yet most critical games do not engage with the technological trajectories being promoted as games' futures.

In response to commercial visions of the future the radical design movement of the late 1960s and early 1970s in Italy arose with an aim that designers and architects should not only be seen as service providers for commercial interests but that they could actively and critically engage in social and political matters. With manifestos, transdisciplinary working methods and utopian design ideals, radical design protested against functionalism and the established practices of design. One of the most influential groups of this time was Superstudio who are cited as highly important by many architects including Zaha Hadid (Stauffer, 2002) whose work reflects this rejection of conformity. In the same time period the UK based group Archigram also promoted a more overtly political stance for design and in particular a utopian socially and politically engaged architecture (Sadler, 2005), but with playfulness analogous to what is seen in some critical games. The critical awareness brought about by radical design has more recently expressed through critical design (Dunne, 2008). Critical design uses design methods and processes to create critical objects, which are often outside of commercial practices and serve an inquisitive or provocative role (Malpass, 2010). The objects are usually counter to conventions or question usability, profit or taste (Mazé and Redstörn, 2007). The practice "rejects how things are now as being the only possibility, it provides a critique of the prevailing situation

through designs that embody alternative social, cultural, technical, or economic values” (Dunne and Raby, 2001, p.58) As described by Dunne and Raby, critical design allows designers to open up a discursive space that accommodates the unavoidable plurality of the future “the idea is not to show how things will be but to open up a space for discussion”. One of the key criticisms of critical design is Dunne and Raby’s assertion of the promotion of the designers’ preferable future which as Prado de O. Martins (2014) states, means “critical design risks to incur the same mistakes as critical theory” by “promoting elitist views of a ‘better world’ that society should aspire towards” (Bowen, 2010). A further critique has been to consider critical design alongside contemporary art practices is that while they try and open spaces for reflection, debate and critique, they are too often displayed in showrooms or galleries (Bardzell, Bardzell and Stolterman, 2014). While we may consider critical games as focusing on introspection rather than entertainment, critical design focuses on introspection over functionality or utility.

While it has been argued that while no formal definition of speculative design exists its focus on designed outputs intended to facilitate discourse with a broad audience, without the emphasis on promoting a preferable aspect seen in critical design, allows for a greater plurality of views to emerge and, when linked with design fiction, could free itself from primarily being displayed in gallery situations (Coulton, Burnett and Gradinar, 2016). Auger (2013) also states that speculative design could present alternative presents as an exploration of ideologies as design proposals. Thus speculative design offers designers a space for reflection, consideration and critique; to imagine other possibilities through the consideration of the rhetoric and ideology distilled into them through the process of design in the same way as critical games. This consideration of rhetoric is important and one we shall explore in more detail in the subsequent section.

Design fiction is of particular interest in relation to technology related futures, as it couples the unequivocal power of science fiction to influence the world (Dourish and Bell, 2014) with design’s inherent world-shaping ability. Design fiction achieves this by creating plausible future worlds that are inhabited by designed objects (Lindley and Coulton, 2015). By placing these designs in a plausible and fully textured world (Coulton, et al., 2017), our relationship with these speculative objects goes beyond mere utility or usability and, to use the anthropologist Lucy Suchman’s (1987) term, are “situated” (ibid). Design fictions can be both a way of communicating visions (Tanenbaum, 2014) and also a way of building inspiring design concepts (Knutz, Markussen and Christensen, 2014). They create discursive spaces (Lindley and Coulton, 2015), which can address the complexity of emerging technology in future scenarios. The aggregate of all these properties means that design fictions can provide *cultural triggers* for hardware, software and system developments.

The term design fiction was coined almost accidentally by the science fiction author Bruce Sterling when he was trying to articulate how design thinking impacted his literary output, “Design fiction reads a great deal like science fiction; in fact, it would never occur to a normal reader to separate the two” (Sterling, 2005). More recently Sterling has refined his thinking on design fiction, defining it as “the deliberate use of diegetic prototypes to suspend disbelief about change” (cited in Bosch, 2012). The term ‘diegetic prototype’, where the *diegesis* is the interior of any given story world, has its origins in David Kirby’s (2009) research into how science is represented and informs cinema, and conversely how cinema informs science. Sterling’s definition underscores the importance creating believable fictional worlds whose coherence is intertwined with the designed prototypes. Julian Bleeker’s (2009) characterization of design fiction as a distinct practice instigated a surge in interest from a range of disciplines.

As design fictions explore these nascent technologies along plausible trajectories (Coulton, Lindley and Akmal, 2016) it is a practice that could be a useful approach for games industry as it is an area that readily embraces new technology. As an example we consider *Game of drones* which is a research paper (Lindley and Coulton, 2015b) that describes a trial in which drones are used to provide services to local authorities, aiding in the enforcement of local by-laws. Specifically, it presents a gamified system in which retired members of the police and armed services act as remote drone pilots helping to enforce by-laws relating to parking offenses and dog fouling in a small UK city. The whole interaction takes place through a game-like interface and points are awarded for catching other citizens infringing upon the rules. The paper was submitted for The ACM SIGCHI annual symposium on computer-human interaction in play (CHI PLAY) 2015 in the Work in progress section and indicates its fictional nature by including design fiction as a keyword at the start of the paper and revealing itself as a speculative artifact in the paper's conclusion. As one of the authors of this paper is also author of this chapter we note that when the paper was reviewed, the reviewer's responses indicated that they had not fully grasped the fictitious nature of the game presented in the paper and this was echoed by some of the reactions of other researchers when the work was presented at the conference (Lindley and Coulton, 2016). Much of the confusion may be due to the fact the paper is written in the style of typical papers in this field. This perhaps suggests that unless the fiction is highlighted significantly within the artifact, our emotional engagement with the fictional world, especially if it resembles a familiar form, might override the signposts explicitly pointing out its fictional nature and provides a good example of the power of this technique (Coulton, Lindley and Akmal, 2016). The paper and the game prototype create a play between the RtD and its exegesis that acts to create and reinforce the fiction in a process of world building. This important link between RtD and other commensurate academic practices helps them work together in a symbiotic relationship to create and situate the knowledge, which as we have previously highlighted, is important in the development of robust and structured approaches to creating research while being aware of the issues associated with method assemblages.

Along with the previously defined attributes of speculative design, critical design, or design fiction, we would also suggest there is another similarity within these approaches in that the resulting artifacts can often appear subversive, irreverent, and frequently humorous in nature in order to break down the barriers to discussion. This suggest that games and play are highly relevant in the context of critical design, speculative design, and design fiction: the games often create a playful subversive and irreverent space, which is analogous to the often described property of games, the *magic circle* (Salen and Zimmerman, 2004), and is perhaps closer to Huizinga's (1955) original discussion as a space for enacting ritual. Having discussed communicative approaches both within design and games how do we bring these areas of design together? One way we suggest is through the consideration of rhetoric and in the following section we explore this further.

DESIGN AS RHETORIC

Before examining rhetoric within design it is worthwhile considering how the term rhetoric is being applied. In some modern contexts, such as politics, it can be associated with insincerity, whilst here it is used in the historical sense relating to the art of persuasive speaking (Rapp, 2010). In terms of applying rhetoric within a specific design context, it can be considered in relation to the three modes of persuasion: *logos* (argument), *pathos* (emotion), and *ethos* (character) identified by Aristotle (cited in Rapp, 2010). Within these three modes various devices can be used to appeal to the audience, for example:

- *Logos* might utilize facts, statistics, analogies, and logical reasoning
- *Pathos* might appeal to our emotions and draw upon feelings of fairness, love, pity, or even greed, lust, or revenge
- *Ethos* would draw upon credibility, reliability, trustworthiness, and fairness.

Although in Aristotle's time, rhetoric was associated only with speech it has developed beyond this:

- to the visual rhetoric associated with image (Kim and DiSalvo, 2010) which is prevalent within marketing
- to all artifacts of design through Richard Buchanan's (1985) argument that all design can be considered as rhetoric.

Ian Bogost (2007) proposes utilizing rhetoric to reveal to the player the underlying processes or concepts that drive a system or activity through playing the game in his book *Persuasive games*.

In relation to games, Bogost (2007) argues that the basic representational mode of videogames is *procedurality*, enacted through rule-based representations and interactions and, when used to reveal processes or concepts of another system, presents the player with a procedural rhetoric. Thus, procedural rhetoric is the practice of using interactive processes persuasively (Bogost, 2007). Whilst we acknowledge that procedural rhetoric is being challenged by some game scholars (Sicart, 2011) this criticism is always focused on procedurality and this then is overshadowing the consideration of rhetoric which is arguably the more important aspect. Just as Buchanan (1985) understands that all design is a form of rhetoric, where objects are encoded with meaning and values by the designer, proceduralists propose that the system of a game, as a designed artifact, can be encoded with meaning and values which are authored by the designer for the player or audience to decode and reflect on. It is worth noting that Bogost's definition differs from Buchanan's argument, whereby all games would be considered as rhetoric. Although Bogost is essentially only promoting the conscious use of rhetoric, his definition would not necessarily preclude its unconscious use, and therefore, as Coulton (2015) argues procedural rhetoric could be applied to the design of all computer mediated interactive systems if we substitute system logic for rules as shown in Figure 2. Perhaps one of the principal differences between speculative design and persuasive games is in relation to commercial constraints as many of the games cited by Bogost (2007) in his book are produced by large commercial entities. In relation to this research we would argue the consideration of all design is rhetoric as one of the most useful ways of unifying design theory with game design theory. This approach to game design, such as critical and speculative design, can open up spaces for reflection and critique for their audiences.

CONCLUSIONS

The aim of this chapter has been to draw from successful approaches used for practice-based research in other design disciplines and suggest how these can be utilized within game design research so that it may better reflect game design practice. With this in mind the first half of the chapter explored approaches to knowledge that are readily considered within practice-based design research and in particular RtD.

Any forms of research in which the experience of the researcher is at work, such as design, can stray towards subjective evaluation, which can lead to criticism that it is not a valid form of knowledge creation. However, RtD has established a number of approaches that help ensure it is not performed

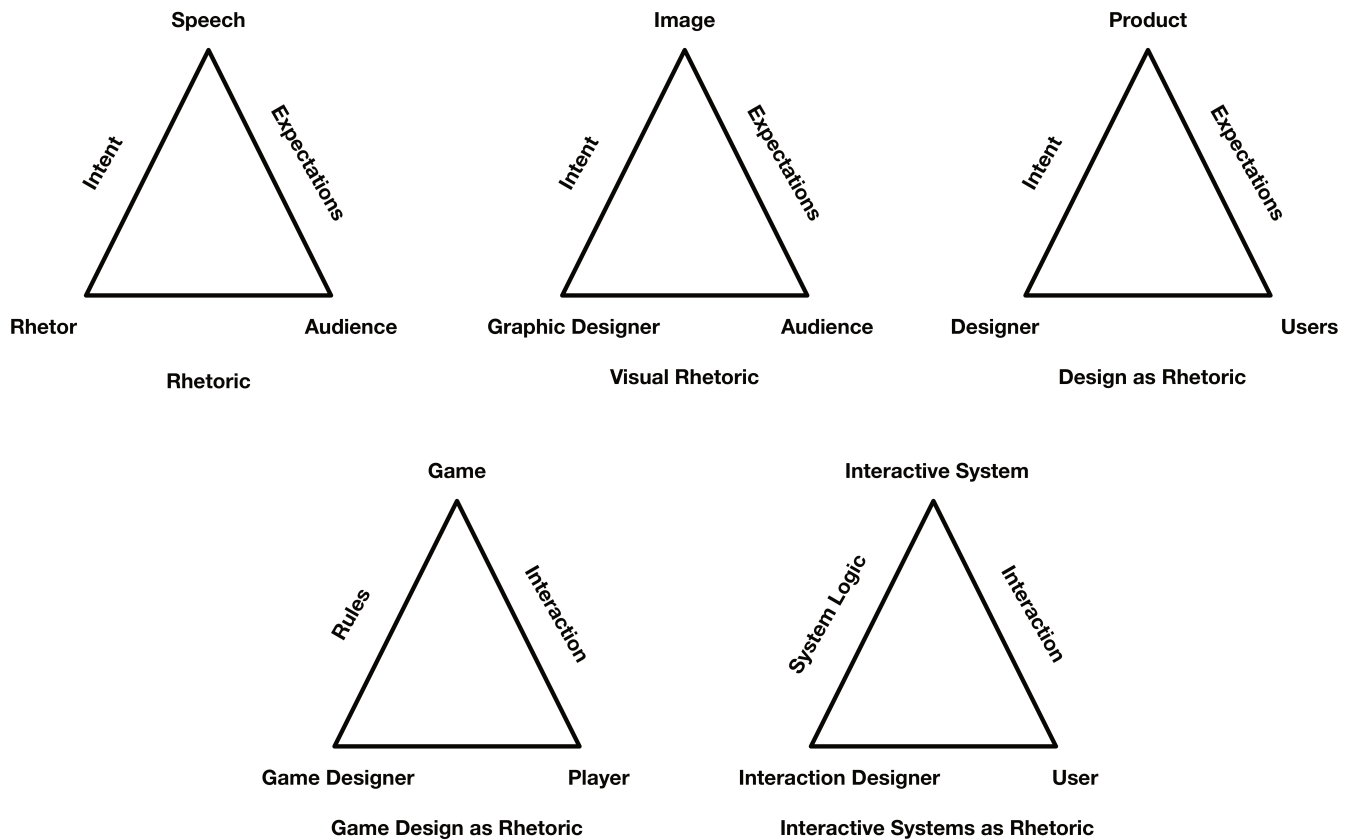

Figure 2. Rhetorical mediums.

through a designer’s personal and privileged perspective, or that it does not reflect either design scholarship or design practice. One of the important facets of RtD is that it both includes, and is included, in the contextual world of design knowledge by being developed with influences from design scholarship and from an acknowledgement of everyday design practices. The knowledge created in design research is thus situated both historically and culturally within design. It is this relationship with the wider context of game design research that will allow practice-based game design researchers to avoid being subjective and to establish a balance between the object and subject of knowledge. Further, RtD can analytically consider design artifacts both in terms of how they reflect the particular research topic under consideration and how they address a particular research question.

To achieve this, practice-based game design researchers need to adopt a critical approach in order to avoid a personal and subjective construction of knowledge. At times during the research, the game design researcher is also a game designer who produces the designed artifacts under consideration. While at other times during the research they need to act as a critical researcher whose aim is to produce knowledge by analyzing and producing insights based on their own experience of the process and from the analysis of the designed artifacts. To allow this dual identity to occur fluidly within the course of the research process requires flexibility within the adopted research methodology to avoid becoming dogmatic about using particular method assemblages.

In this chapter we have argued that a constructivist approach to research through game design can both provide this flexibility and produce valid knowledge as long as the research adopts certain

practices that produce the transparency required through which the validity of the research can be externally considered by others scholars. The game design researcher must therefore clearly define both their motivations for doing the research and their own personal background as these will ultimately affect the decisions they make during the design process. The game design researcher also needs to provide an in-depth description of their experience during the design process, how the process was performed, and how decisions within the process were made. This also means that the format in which the research is presented must facilitate such presentation. As part of the chapter we suggested that the annotated portfolios provide a good vehicle for such a presentation although this format needs to be better accommodated in the venues for reporting game design research. While some HCI conferences are experimenting with alternate formats they are not yet widely used or accepted. The subject and object of the design need to be situated within the wider world in different ways, for example, through player testing and interviews with other game designers or researchers. The final designed artifacts themselves also have to be critically interrogated as, even though all their design and development has been documented, they are always likely to reveal something unexpected that provides more information, more insights, creates more questions, and indeed define new research problems that start the process again. It is worth noting that this all can be performed without the need for quantitative analysis and indeed can be done with a small number of participants as long as the insights gained from the player sessions are described in depth. We further highlighted that adopting a grounded approach will allow the game design researcher to analyze findings from the design process and compare it with other data gathered from the wider context of game design. Whilst this approach to design research implies a qualitative approach to research that to some disciplines is problematic, it has been shown such research can be further validated through triangulation (Swann, 2002). This means that knowledge produced through the act of designing may offer a stronger argument if it is backed up by other different methods to gain the same kind of knowledge.

The second half of this chapter considered design approaches, such as *speculative design*, *critical design*, and *design fiction*, in relation to similar approaches with games design that broadly come under the banner *critical play*. Whilst all these approaches center on design that focuses on the creation of expressions of cultural understandings, critical play has tended to focus its criticism on either the games industry or games themselves. However, through the frame of rhetoric all these techniques can be united and potentially open up opportunities of extending critical practice in games. Further, Coulton, Burnett and Gradinar (2016) have argued that games offer an exciting medium for critical design, speculative design, and design fiction in that they can free these practices from the criticism that they are often only ever seen in art galleries and thus they can be used engage a wider audience by presenting complex issues in a way “that allow players to consider the societal impacts of alternative presents and plausible futures” in a variety of contexts. Overall we believe this chapter highlights alternate approaches to game design research by drawing significant parallels between game design and practice-based design research more generally, that valid research can indeed be achieved through game design practice, and has the potential to enrich the area of game design research.

ACKNOWLEDGEMENTS

Paul Coulton: The work in this chapter is a reflection of my design practice in relation to numerous projects performed at Lancaster University over many years. I would particularly like to thank a number of my PhD students for having the faith to design and play games with me over this time most notably Omer Rashid, Fadi Chehimi, Carlos Garcia Wylie, Will Bamford, Zhang Lei (Kevin), Kate Lund, Mark Lochrie, Dan Burnett, Adrian Gradinar, Dave Gullick, Joe Lindley, and Jonny Huck.

Alan Hook: This chapter was born from discussion and reflections on design with Prof. Paul Coulton. I would like to thank him for his guidance, experience, support and mentorship. Some of the ideas that I brought to the table grew from arguments within my department at Ulster University around research through practice. I would therefore like to thank my colleagues Dr. Helen Jackson and Mr. Adrian Hickey for the positive discussions we've had about the generation of valid knowledge through thinking, making, and reflecting and my Research Institute Director, Dr. Robert Porter for his support of my research even when it was challenging, bewildering and purely speculative.

BIBLIOGRAPHY

Anthropy, A., 2012. Rise of the videogame zinesters: How freaks, normals, amateurs, artists, dreamers, drop-outs, queers, housewives, and people like you are taking back an art form. Seven Stories Press.

Arnall, T. and Martinussen, E.S., 2010. Depth of field: Discursive design research through film. *FORMakademisk—research journal for design and design education*, 3(1).

Atkinson, P., 2013. Delete: a design history of computer vapourware. Bloomsbury Academic.

Auger, J., 2013. Speculative design: crafting the speculation. *Digital Creativity*, 24(1), pp.11–35.

Balsamo, A., 2011. Designing culture: The technological imagination at work. Duke University Press.

Bardzell, J., Bardzell, S. and Stolterman, E., 2014 Assessing critical designs: Supporting reasoned debates about critical design. *Proceeding of CHI'14*. ACM.

Bleecker, J., 2009. Design fiction: A short essay on design, science, fact and fiction. *Near Future Laboratory*, 29.

Bogost, I., 2007. *Persuasive games: The expressive power of videogames*. MIT Press.

Bogost, I., 2009. Videogames are a mess. Keynote speech at DiGRA. Available at: <http://bogost.com/writing/videogames_are_a_mess/>.

Bogost, I., 2011. *How to do things with videogames*. University of Minnesota Press.

Bosch, T., 2012. Sci-Fi writer Bruce Sterling explains the intriguing new concept of design fiction. *Slate*, March, 2.

Bowen, S., 2010. Critical theory and participatory design. In Proceedings of the SIGCHI conference on human factors in computing systems 2010, CHI 2010. ACM, pp.68–77.

Bowers, J., 2012, June. The logic of annotated portfolios: communicating the value of research through design. In *Proceedings of the designing interactive systems conference*. ACM, pp.68–77

Buchanan, R., 1992. Wicked problems in design thinking. *Design Issues*, 8(2), pp.5–21.

Buxton, B., 2007. Sketching user experience: Getting the design right and the right design. San Francisco: Morgan Kaufman

Charmaz, K. and Mitchell, R.G., 1996. The myth of silent authorship: Self, substance, and style in ethnographic writing. *Symbolic Interaction*, 19(4), pp.285–302.

- Clarke, A., 2005. *Situational analysis: Grounded theory after the postmodern turn*. Sage.
- Coulton, P., 2015. The role of game design in addressing behavioural change. In: *Proceedings for 11th European Academy of Design conference 2015*, EAD 11.
- Coulton, P., Burnett, D. and Gradinar, A.I., 2016, Games as speculative design: Allowing players to consider alternate presents and plausible futures. In: *Proceedings of Design Research Society conference 2016 DRS 2016: Future focused thinking*. Brighton, United Kingdom, 27–30 June.
- Coulton, P., Lindley, J. and Akmal, H.A., 2016. Design Fiction: does the search for plausibility lead to deception? In: *Proceedings of Design Research Society conference 2016. DRS 2016: Future focused thinking*. Brighton, United Kingdom, 27–30 June.
- Coulton, P., Lindley, J. G., Sturdee, M. and Stead, M., 2017. Design fiction as world building. In: *Proceedings of research through design conference 2017*.
- Cross, N., 1993. A history of design methodology. In: M.C. de Vries, N., Cross and D.P. Grant, eds. *Design methodology and relationships with science*. Springer Netherlands, pp.15–27
- Cross, N., 2001. Designerly ways of knowing: Design discipline versus design science. *Design Studies*, 17(3), pp.49–55.
- Crotty, M., 1998. *The Foundations of Social Research*, Sage.
- Deterding, C.S., 2016. The pyrrhic victory of game studies: Assessing the past, present, and future of interdisciplinary game research. *Games and Culture*, online first,
- Dorst, K., 2011. The core of ‘design thinking’ and its application. *Design Studies*, 32(6), pp.521–532.
- Dourish, P. and Bell, G., 2014. “Resistance is futile”: reading science fiction alongside ubiquitous computing. *Personal and Ubiquitous Computing*, 18(4), pp.769–778.
- Dunne, A., 2008. *Hertzian tales: Electronic products, aesthetic experience, and critical design*. MIT Press.
- Dunne, A. and Raby, F., 2013. *Speculative everything: Design, fiction, and social dreaming*. MIT Press.
- Erickson, T., 1996. Design as storytelling. *Interactions*, 3(4), pp.30–35.
- Flanagan, M., 2009. *Critical play: Radical game design*. MIT press.
- Flanagan, M. and Nissenbaum, H., 2014. *Values at play in digital games*. MIT Press.
- Foth, M. and Axup, J., 2006. Participatory design and action research: Identical twins or synergetic pair? In: *Proceedings of the participatory design conference 2006*. pp.93–96.
- Frankel, L. and Racine, M., 2010. The complex field of research: For design, through design, and about design. In: *Design & complexity: International conference of the Design Research Society*. Montreal (Quebec), Canada. July 7–9 2010, Design Research Society.
- Frayling, C., 1993. *Research in art and design*. Royal College of Art.

- Gaver, B., Dunne, T. and Pacenti, E., 1999. Design: Cultural probes. *Interactions*, 6(1), pp.21–29.
- Gaver, B. and Bowers, J., 2012. Annotated portfolios. *Interactions*, 19(4), pp.40–49.
- Gaver, W., 2012. What should we expect from research through design?. In: *Proceedings of the SIGCHI conference on human factors in computing systems*. ACM, pp. 937–946.
- Godin, D. and Zahedi, M., 2014. Aspects of research through design: A literature review. In: *Proceedings of Design Research Society 2014, DRS 2014*.
- Grace, L., 2010. Critical gameplay: Design techniques and case studies. In: D. Gibson and K. Schrier, eds. *Designing games for ethics: Models, techniques and Frameworks Information Sciences Reference*. Hershey, pp.128–141
- Grace, L., 2014. Critical games: Critical design in independent games, In: *Proceedings of Digital Games Research Association conference 2014, DiGRA 2014*.
- Gray, D., Brown, S. and Macanufo, J., 2010. *Gamestorming: A playbook for innovators, rulebreakers, and changemakers*. O'Reilly Media, Inc.
- Gualeni, S. 2015., *Virtual Worlds as philosophical tools: How to philosophize with a digital hammer*. AIAA Press.
- Huizinga, J., 1955. *Homo ludens: A study of the play-element in culture*. Beacon Press.
- Jameson, F., 1985. Postmodernism and consumer society. *Postmodern culture*, pp.111–125.
- Kim, T. and DiSalvo, C., 2010. Speculative visualization: a new rhetoric for communicating public concerns. In: *Proceedings of the Design Research Society 2010, DRS 2010*.
- Kirby, D., 2009. The future is now: Diegetic prototypes and the role of popular films in generating real-world technological development. *Social Studies of Science*, 40(1), pp.41–70.
- Knutz, E., Markussen, T. and Christensen, P.R., 2014. The role of fiction in experiments within design, art & architecture. *Artifact*, 3(2), pp.1–8.
- Kroes, P., 2002. Design methodology and the nature of technical artefacts. *Design Studies*, 23(3), pp.287–302.
- Law, J., 2004. *After method: Mess in social science research*. Routledge.
- Law, J., 2007. Making a mess with method. In: W. Outhwaite and S. Turner, eds. *Handbook of social science methodology*. Sage, pp.595–606.
- Lindley, J. and Coulton, P., 2015a, July. Back to the future: 10 years of design fiction. In: *Proceedings of the 2015 British HCI conference*. ACM, pp.210–211.
- Lindley, J. and Coulton, P., 2015b.. Game of drones. In: *Proceedings of the 2015 annual symposium on computer-human interaction in play*. October, 2015. ACM, pp.613–618.

- Lindley, J. and Coulton, P., 2016. Pushing the limits of design fiction: the case for fictional research papers. In: *proceedings of the 2016 CHI conference on human factors in computing systems*. ACM, pp.4032–4043.
- Malpass, M., 2010. Perspectives on critical design: A conversation with Ralph Ball and Maxine Naylor. In: *Proc. of DRS'10*.
- Martinussen, E., Knutsen, J. and Arnall, T., 2014. Satellite lamps, Kairos. *A Journal of Rhetoric, Technology, and Pedagogy*, 19(1).
- Martins, L. P.D.O., 2014. Privilege and oppression: Towards a feminist speculative design, In: *Proceedings Design Research Society 2014, DRS 2014*.
- Mazé, R. and Redström, J. 2007. Difficult forms: Critical practices of design and research. In: *Proceedings of IASDR'07*. Available at: <<http://www.sd.polyu.edu.hk/iasdr/proceeding/>>.
- Moggridge, B., 2007. *Designing interactions*. MIT Press.
- Mol, A. and Law, J., 2002. Complexities: an introduction. In: *Complexities: Social studies of knowledge practices*, A. Law and J. Mol, eds. Duke University Press.
- Mukherjee, S., 2016. Playing subaltern video games and postcolonialism. *Games and Culture*, online first.
- Nacke, L., Drachen, A., Kuikkaniemi, K., Niesenhaus, J., Korhonen, H.J., Hoogen, W.M., Poels, K., IJsselsteijn, W.A. and De Kort, Y.A., 2009. Playability and player experience research. In: *Proceedings of DiGRA 2009: Breaking new ground: Innovation in games, play, practice and theory*. DiGRA.
- O'Reilly, T., 2009. *What is web 2.0*. O'Reilly Media, Inc.
- Rapp, C., 2010. Aristotle's rhetoric. In: E.N. Zalta, ed. *The Stanford Encyclopedia of philosophy*. Available at: <<http://plato.stanford.edu/archives/spr2010/entries/aristotle-rhetoric/>>.
- Rittel, H.W., 1972. *On the planning crisis: Systems analysis of the "first and second generations"*. Institute of Urban and Regional Development, pp.390–396.
- Rodríguez Ramírez, E.R., 2009. An epistemology for research through design. In: *Proceedings education conference of the International Council of Societies of Industrial Design (ICSID)*, Singapore, October 22–27.
- Sadler, S., 2005. *Archigram: Architecture without architecture*. MIT Press.
- Schön, D.A., 1983. *The reflective practitioner: How professionals think in action*. Basic books.
- Schwandt, T.A., 1994. Constructivist, interpretivist Approaches to Human Inquiry. In: N.K. Denzin and Y.S., eds. *Handbook of qualitative research*. Sage, pp. 118–137.
- Lincoln, eds. 2005. *Handbook of qualitative research*. Sage.
- Sicart, M.A., 2011. Against proceduralism. *Game Studies*, 11(3).
- Simon, H.A., 1981. *The sciences of the artificial*. Cambridge: MIT Press.

- Stauffer, M.T., 2002. *Utopian reflections, reflected utopias: Urban designs by Archizoom and Superstudio*. Architectural Association.
- Sterling, B., 2005. *Shaping things*, Mediaworks Pamphlets.
- Stickdorn, M., Schneider, J., Andrews, K. and Lawrence, A., 2011. *This is service design thinking: Basics, tools, cases*. Wiley.
- Strauss, A. and Corbin, J., 1990. *Basics of qualitative research*. Sage.
- Suchman, L.A., 1987. *Plans and situated actions: The problem of human-machine communication*. Cambridge University Press.
- Sunderland, I. and Acord S.K. 2007 Thinking with art: from situated knowledge to experimental knowing, *Journal of Visual Art Practice* 6(2), pp.125–140
- Swann, C., 2002. Action research and the practice of design. *Design Issues*, 18(1), pp.49–61.
- Tanenbaum, J., 2014. Design fictional interactions: why HCI should care about stories. *Interactions*, 21(5), pp.22–23.
- Verplank, W., 2009, *Interaction Design Sketchbook*. Available at <ccrma.stanford.edu/courses/250a/lectures/IDSketchbok.pdf>.
- Waern, A. and Back, J., 2015, January. Experimental game design. In P. Lankoski and S. Björk, eds. *Game research methods..* ETC press, pp.341–353.
- Zimmerman, J., Forlizzi, J. and Evenson, S., 2007. Research through design as a method for interaction design research in HCI. In: *Proceedings of the SIGCHI conference on human factors in computing systems..* ACM, pp.493–502.

CHAPTER 6

GAME DESIGN MISE-EN-SCÈNE PRACTICE

INTENTION AND MEANS IN JEU SERAI

EMMANUEL GUARDIOLA AND STÉPHANE NATKIN

What is the *mise-en-scène* in a game or in other media? Undoubtedly it is a creative aspect of the production process. In filmmaking, it is the way we use a certain number of *means* to serve an intention (Bordwell and Thompson, 2003), as for instance a narrative purpose, an emotional arise, a message. This list of *means* vary but it includes set design, lighting, acting, and costumes. In this chapter, the term *means* refers to these elements, these tools, that serve the intention of the designers or the directors. In Hillier's (1985, pp.8–9) definition, the list of means can be broader than the one we find for the stage of a theater or a movie set: "Mise en scene is nothing other than the technique invented by each director to express the idea and establish the specific quality of his work." From this point of view, camera angle, post-production, editing (etc.) are part of the potential tools. This approach could be the basis of a definition of *mise-en-scène* for games, where most of the work is done beyond the *stage*. Even the level design phase of game production, that which is closest to staging in a theatre production, is mostly an assembly of virtual components.

Mise-en-scène in a game might include means similar to those in a film, such as lighting, camera parameters, animation, voice acting, sound or visual special effects, and environment design. Ian Bogost (2007) pointed procedural rhetoric as a method for conveying meaning unique to the medium of games. The dynamic, interactive experience of gaming demands a set of means particular to the medium. In game design the *mise-en-scène* list of means includes, but is not limited to: rules, interactions design, difficulty management, learning curve, real time rendering, signs and feedbacks, and all elements that contribute to generate the targeted experience for the player.

For the most part, literature does not fully explore this dimension of game design work. For example, Rollings and Morris (2000) and Schell (2008) focus on game design tools, recipes, or a general introduction to game design processes. There are no deep references to *mise-en-scène*, nor exhaustive studies on the rational link between means and intentions. However, in the industry, managing the means to serve an intention is an everyday reality. It remains mostly an intuitive process. If there is an obvious *mise-en-scène* work on many games, the design tools themselves are not documented nor are they accessible for research. With this chapter, we document the *mise-en-scène* process, and potentially rationalize it.

In 2004, Ubisoft launched an internal game design research program to establish a design methodology for the training of its core team members. This industrial research project provides examples of the ways game designers can formalize the links between means and intention in games. The types of intention were mostly about emotional game experience or narrative, but they also relate

to conveying meaning. This Ubisoft's game design research program constitutes a formal approach to *mise-en-scène* for games.

In the research project JEU SERAI, a serious game with a real life objective, we apply the same kind of *mise-en-scène* approach. The means serve a specific purpose: identify the position of a player within the dimensions of a psychological model. A side effect of the psychometric test realized during the experimentation phase also highlights the efficiency of the *mise-en-scène* means. This case study is an interesting, rational glimpse at the relation between creative intention and the nature of the means used to realize it.

RATIONAL MISE-EN-SCÈNE IN PRIOR CONTEXTS

In the following, we will document the game research project started at Ubisoft as an example of an industrial rational approach to *mise-en-scène*. In 2004 the author Emmanuel Guardiola worked as game researcher with the editorial team and under the supervision of Caroline Jeanteur, organizational development director. At that time, the number of productions and team sizes increased: there was a need to train the new recruits and to keep the experienced designers updated with new design approaches. The goal of the research project was to provide new creative tools and examples of their use to core teams of various Ubisoft studios. One of the research topics was the *mise-en-scène* aspect of game design. This was the first documented attempt to rationalize the relationship between means and intention in game design.

The main experimental game, *Peter Jackson's King Kong* (Ubisoft, 2005), was the adaptation of movie into a video game. The core design team worked on developing a strong emotional intention. The core emotions they hoped to trigger were empathy with the character of Anne, fear, and a feeling of power. From the very start of the design process, the creative team associated various means to specific emotions.

Figure 1 is an experimental table, designed from the different documents created by the team. The major part of the first column is a list of *mise-en-scène* means: gameplay mechanic, character, type of environment, specific animation, scripted sequence, type of monster, sound, and so on. The other columns are the succession of game situations or sequences. The goal of this table was to identify and manipulate the means that were used to push a particular emotion in a particular sequence of the game. We used colors in cells to represent the different emotions present in a given situation, and we positioned them in the rows signifying the means that support a particular emotion. In some cases, we described the nature of the means with more precision. For instance in the *Light* (Lumière) row, of the first column and sequence, we specified "Night. Little torches on the launches, blinding lightning flashes" (nuit, petits projecteurs sur les chaloupes, éblouissement éclairs). The color specific to this particular means in this sequence is blue, the code we used to tag "Fear". Even if the entire game did not rely on the support of these tools, it reflects the core design team's process of thinking: having clear defined means supporting targeted emotions.

When *King Kong* was released in 2005, several internal studies were launched. Even if the studies were not conducted in a strict scientific context, they were part of an attempt to rationalize the *mise-en-scène* process. First, internal tests were conducted to evaluate the emotional impact of some sequences of the game on players. A psychologist (Thomas Gaon) and an ergonomic expert (Xavier Retaux) helped establish the protocol. The results indicated a tendency toward a positive response: the sequences seemed to provoke the targeted emotion. And for the meta-emotional objective, the

Game design	1	2	3
Situations			
Procédés uniquement dans cette séquence	description		
Kill all Monsters Arena			New
Kill monsters until event			
Big Monsters Timing	New		
Big Monsters to Flee			
Cool Dino Cover			
Reflex shooting			
Tactic shoot food chain			
Tactic shoot elements			
Cover others	New		
Others cover self	New		
Mutual cover crossing			
Sidekick keys			
Stealth open range (grass...)			
Stealth elements (indoor, trees...)			
Stealth with water			
Silent Killing			
Move cautiously (minefield principle)			
Move with monster			
Ball trap sequence		New	
Last chance shoot for other			New
Last chance shoot for self			
Water Ride shooting	New		
Water Ride monster on board			
Swimming timer	New		
Air Ride shooting			
Air Ride monster on board			
Possible insertion éléments de gameplay type fiche level PC/P4			

Décor	1	2	3
Nom	Sea and Coast	Coast rock way	Crabs lair
Type	Exit Nuit	Exit Nuit	Exit Nuit
Topologie principale	Ride	couloir	laboratoire
Lumière	Nuit, petits projecteurs sur chaloupes, éblouissements eclairs	Nuit, lampe marin, éblouissements eclairs	Pénombre, lampe marin Ann, projection lumière eclairs par des
Climat	Tempête avec pluie	Tempête avec pluie	Tempête avec pluie
Ambiance autres	Vagues faisant monter et descendre les chaloupes		
Noter s'il y a des variations importantes	Les vagues se calment progressivement		La tempête se calme
Éléments de décors EF CI			
KIT sur KK			
Éléments de décors	Morceaux de roches au formes agressives sortant des flots	Eau Ml-cuisse par endroit	ossements Cadavres d'humains
Éléments de décors	L'île en fond, halo de lumière des feux du village	Morceaux de roches au formes agressives sortant des flots	Passages étroits, manque de visibilité
Éléments de décors	Zebrures Eclairs avec ou sans impact	Zebrures Eclairs avec ou sans impact	
Éléments de décors			
Éléments de décors			
Éléments de décors			
Effets sonores associés EF CI			
Effets sonores	Racléments sous chaloupes	Bruits de crabs non visibles progressant dans les rochers	Echos des mouvements de crabes dans les tunnels
Effets sonores	Tonnerre	Tonnerre	
Effets sonores	Vagues se fracassant sur les rochers		
Effets sonores			
Effets sonores			
Effets sonores			
Enemies	1	2	3
Monstre Marin	New		
Comportement particulier	Un monstra marin surgit près de la barque pour saisir Jack		
Sons spécifiques	Gargouille et impact entendu par jack pris dans sa gueule		
Animes spécifiques	Mouvements faciaux: qd Jack est pris dans sa gueule		
Crab Small		New	2nd
Comportement particulier		Arrivée effet de surprise, mais facile à détruire	Surgissent du corps des Hudge
Sons spécifiques			
Animes spécifiques			

Figure 1. Extract of an experimental mise-en-scène tool from the production Peter Jackson’s King Kong.

players seemed to be attached to Anne. Furthermore, popular critical reviews tended to highlight the emotional qualities or the game.

In this Ubisoft research project, a second game was used as a game design experiment tool support: *Ghost Recon Advanced Warfighter* (Ubisoft, 2006). Even though the means versus intention relationship remained the same, the nature of the intention was different. The lead game designer Gilles Matouba used the intention-means mise-en-scène approach to manage what he defined as the “player’s experience.” Figure 2 shows a table representing the progression of the player in the first mission, composed of a succession of 15 sequences represented by the columns. It is an early stage design document so the content of the mission evolved by the final release of the game. The game designer wanted to use the game elements, the means, listed in the first column, to vary the player experience on an axis from “Tactical” (green) to “Endure” (red). Here the list of means focuses mainly on gameplay elements and the nature of the challenge: types of enemies, types of weapons, presence of cover, and

so on. The top part of the table sums up the number of elements employed to push the experience in one direction or the other on the axis. The line graphs on the right display the expected level of challenge in relation to the player experience. It was a rational tool to manage the relation between the game's means and intention.

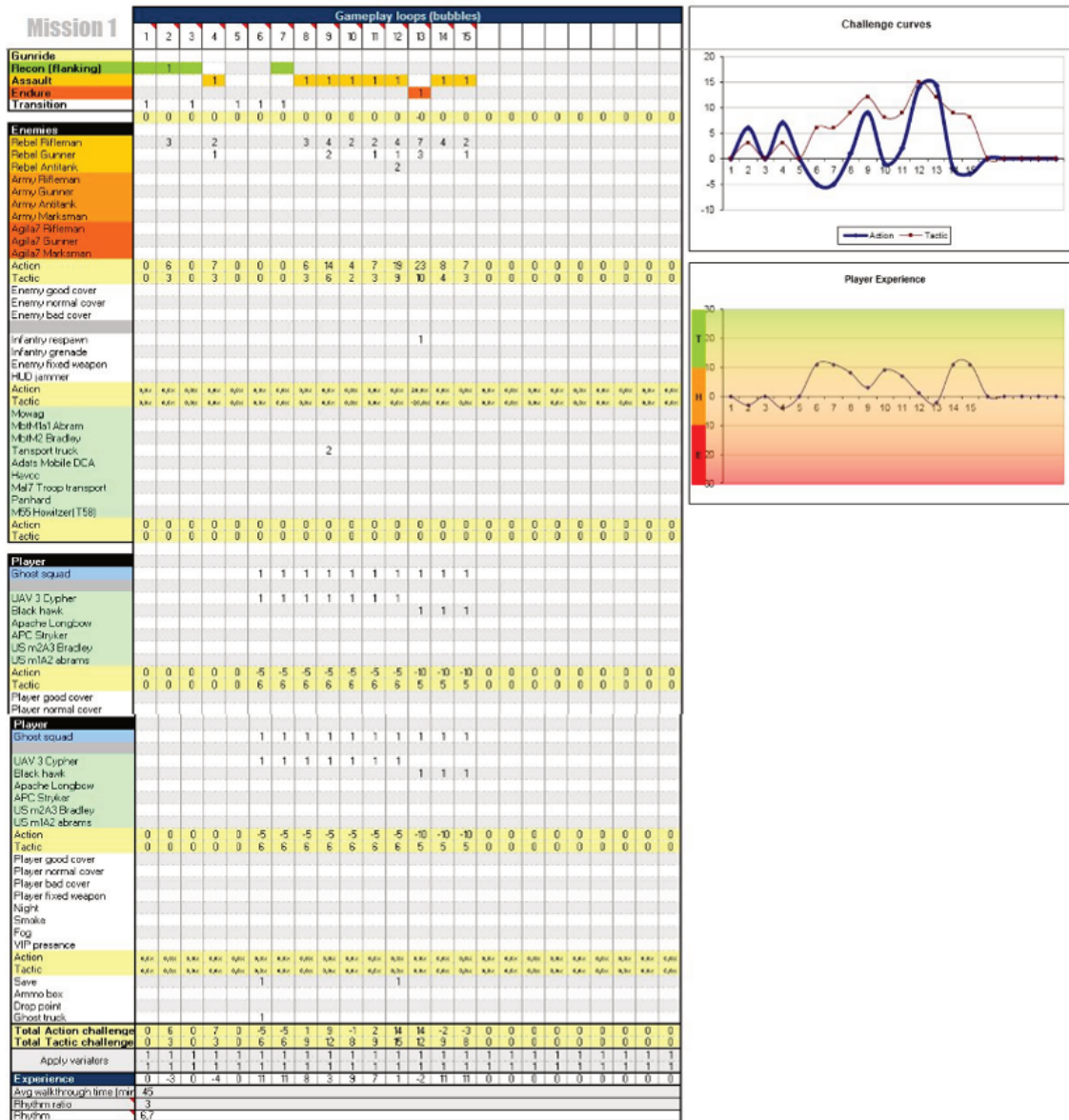

Figure 2. Extract of early rational level design document including player experience management, during *Ghost recon advanced warfighter* production.

The mise-en-scène approach can seem obvious in creative fields such as theater or movies. In these two Ubisoft examples, the goal was to adapt it to video game design, in an entertainment industry context. The intentions in these two cases are in the emotional and player experience domains. In the cases, the design teams tried to formalize a rational link between these intentions and the means they want to use to achieve the intentions.

THE JEU SERAI CASE STUDY

The research project JEU SERAI challenges the *mise-en-scène* approaches represented by the previous Ubisoft examples. The intention of JEU SERAI is different than that of a pure entertainment game: here the means have to strongly convey different psychological dimensions. One of the interesting aspects of this project is that we were able to use a psychometric test to evaluate the pertinence of the *mise-en-scène* link between means and intention.

CONTEXT OF THE PROJECT

JEU SERAI was the main experimental phase of a research project on game design methodology to generate a psychological profile of the player. The main purpose of the methodology is detailed in a previous publication (Guardiola and Natkin, 2015). The goal was to collect in-game data of player behavior and to correlate it to the dimensions of an existing psychological model, and to evaluate the quality of the generated psychological profile.

The name of the prototype is JEU SERAI. Its ambition is to help the vocational guidance of students and adults at an individual level. It was developed in a consortium composed of two companies (Wizarbox and Seaside Agency), two universities (CNAM and UPOND), and an adult training association (ARCNAM Poitou-Charentes). It was funded by the French ministry of economy in the framework of a national call for serious game experimental projects. The game received the European Games for Change Award in 2011.

In vocational guidance process, there is a moment when the subject, for instance a student, must understand herself as well as her wishes and preferences in terms of a career. The classical ways to generate a subject profile is to pass a test, a questionnaire, on paper or online. These self-evaluation tools are used as material to work with career counselor. JEU SERAI wants to experiment the use of a game instead of a questionnaire. The player's activity in-game is connected to a widely used vocational guidance inventory: the Holland model (Holland, 1966). This model measures the interest of the subject in a professional context.

GAME DESCRIPTION

JEU SERAI is a PC game developed with Unity (Unity Technologies). It is a small open world game, inspired by *Animal crossing* (Nintendo, 2008). The player explores a village and meets non-player characters. These inhabitants give him quests. To solve them, he has to perform mini-games. There are 18 mini-games disseminated in the game world. The player has to finish them all to complete the game. JEU SERAI consists of many other optional activities but these mini-games are the core aspect of the data collecting process, and the main features related to the rational *mise-en-scène*.

HOLLAND'S MODEL DIMENSIONS AS INTENTIONS

The work of John Holland considers that six types of dimensions are sufficient to measure a career interest. The model, known as the RIASEC, is composed of the *realistic*, *investigative*, *artistic*, *social*, *enterprising*, and *conventional* dimensions. They are represented in his model, reproduced in the figure 3. More than 50 years of use in vocational guidance provides us much literature and existing tests. In these tests, the subject has to point to his preference within a list of objects. For instance, some tests are based on profession lists, working places, activity verbs, and sometimes images. These already existing paper and online tests are useful materials for designing video game features (gameplay actions, characters, environments, and so on).

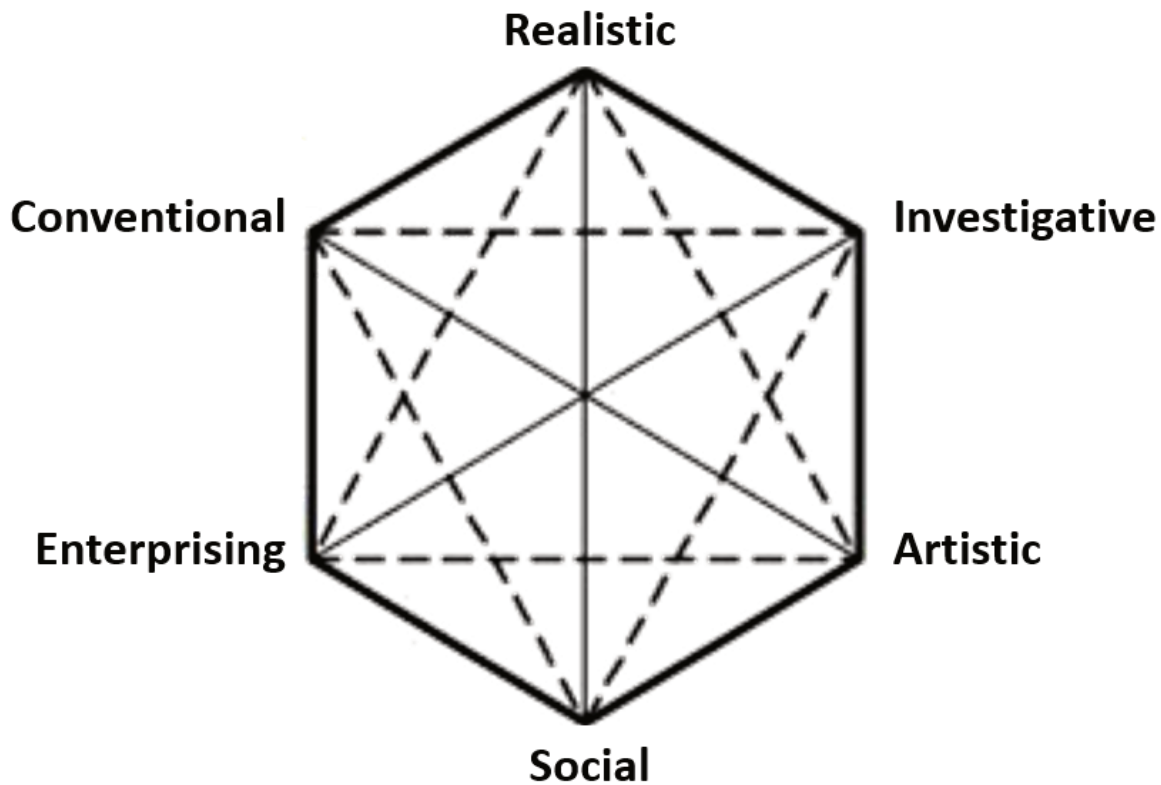

Figure 3. Holland model of professional interest, the RIASEC.

The main way to achieve the profiling in JEU SERAI is to measure player's preference among several mini-games, each of these mini-games being strongly dedicated to a dimension of Holland's inventory. Table 1 shows a list of the 18 mini-games cross listed with the related RIASEC dimension and the designated metaphoric activity completed by the player. The mini-games are grouped by six and constitute different days in the village. Each time the player achieves the six mini-games quests, a day ends and a new one starts.

The six dimensions of RIASEC are for us the core intentions of the mise-en-scène of each mini-game. Some of the important psychometric items of JEU SERAI are the way the player can show her preference for a mini-game and its corresponding RIASEC dimension. There are grading and ranking activities embodied in the game. After she plays a mini-game, the player has to grade it, and at the end of a virtual day, she has to rank them in order of preference. Her choices here are the basis of her RIASEC profile.

This approach implies that the game design of each mini-game must convey the dimension it represents with efficiency. This is a brief description of all six types of the RIASEC dimensions. It is a translation of an extract from Demangeon (1984):

- *Realist* is characterized by a preference for technical or outdoor type of activities that involve the manipulation of objects, tools, machinery or contact with animals and the corresponding skills, technical or physical.

RIASEC type	Mini-game name / "French original name"	Metaphoric activity
Day 1 Theme: Welcome to the Village		
R	Nice Apple / "La bonne pomme"	Apple harvesting
I	Invasion of the Ants / "L'invasion des fourmis"	Ant observation
A	Autumn fashion / "Création d'automne"	Designing a t-shirt
S	Ms Petitpas shopping / "Les courses de Mme Petitpas"	Taking care of a senior lady
E	Omelet / "Omelette"	Directing a team in a workshop
C	Classified! / "Classe!"	Classifying stamps
Day 2 Theme: The Tempest		
R	Tile / "La tuile"	Repairing a roof
I	Light / "Lumière"	Finding the cause of a breakdown
A	Photos	Photo journalism
S	Take shelter! / "Aux abris"	Convincing people to take shelter
E	Sand and sweat / "Du sable et de la sueur"	Leading a team of porters
C	Stock	Stock management
Day 3 Theme: The Village Party		
R	Assembly / "Assemblage"	Assembling theater set elements
I	Chemistry set / "Le petit chimiste"	Manipulating a chemistry set
A	Decoration / "Déco"	Art direction of a stage set
S	Reception / "Accueil"	Welcoming visitors
E	Promotion	Managing the ticket sellers
C	Good seat / "Chacun sa place"	Being the usher in the theater

Table 1. The 18 mini-games and their respective Holland RIASEC dimensions

- *Investigative* corresponds to the preferences and skills for research activity in the physical, biological, or cultural field. The intellectual individual attributes great value to science. He prefers reflection to action.
- *Artistic* is defined by preferences, skills and values in the arts, in the field of free activity, [...] where the subject [...] performs a creation in which he expresses his feelings and emotions.
- *Social* prefers activities where it can have the action on the other, but in their own interest: education, care, consulting. He is good at human relations and values are social and moral order.
- *Enterprising* likes activities where he can manipulate others, but unlike the social type, he does it in his own interest, to obtain services or profit: it is the politician, the businessman, the merchant. He promotes the economic or political success.
- *Conventional* corresponds to desk jobs. His preferences go to explicit manipulation, orderly



Figure 4. Screenshots of the grading and ranking activities in JEU SERAI.

and systematic data, and he excels at making records, rankings, and calculations. He attributes value to the social and material success.

THE LIST OF MEANS

In the game design process, we determined a list of means as indicators of our rational mise-en-scène. There were a limited number of elements related to the specific case of JEU SERAI. For instance, as the game can be played in a noisy public environment, sound is not used as a critical indicator. The prototype does not even have any sound. In our list, there are some elements directly related to assets or features visible on screen, like the shape of the cursor. We also include gameplay-descriptive elements, for example the verbs describing the type of actions the player is doing while playing. To illustrate the following list of element explanations, we use examples from the *Nice Apple* mini-game (Figure 5).

There are three groups of elements:

Gameplay elements:

- Simulated activity. Or what is the fictional or metaphorical aspect of the mini-game, according to Juul (2005). In the mini-game *Nice apple*, the player simulates the harvesting of apples.
- Gameplay action verbs. We refer to action verbs that can describe what the player is actually doing when playing the game. This approach is based upon previous work on gameplay profiling criteria (Guardiola and Natkin, 2010). In *Nice apple*, the player tries to pickup apples within the right timing
- Objective (form and content). The mini-game objective: filling three baskets of apples.

Interaction loop and mini-game environment: These elements are concrete assets visible on screen during the mini-game session. They are mostly related to the player interaction loop as Swink (2009) describes it.



Figure 5. Nice apple prototype screenshot.

- The cursor aspect. What the player is directly controlling with the mouse. In *Nice apple*, the cursor is changed into pruning shears.
- Handled elements and interaction targets. All the interactive elements. For instance the apples we have to harvest.
- Interactions feedback. When the player is interacting with the game world, the game provides explicit feedback to acknowledge player actions. When the player clicks on an apple, the apple falls and leaves are generated at the point of the click.
- Non-interactive animated elements. These are signs or stimuli that help the player understand the context, or to bring some life to the environment. Here, there is a non-playable character also harvesting with the player.

Setting and character in the open world: Mini-games are launched when the player clicks on an inhabitant of the village. In the later stages of the game development, we added elements related to this launching context.

- Triggering location. In what type of environment is the player located when he launches the mini-game? For *Nice apple* the triggering location is at the farm.

- Triggering character. Who is the non-playable character who gives the quest (launches the mini-game) to the player? Here it is the farmer.

METHOD TO RATIONALIZE THE LINK BETWEEN INTENTION AND MEANS

During the game design work of JEU SERAI, we needed a clear method to highlight the link between each mean of our mise-en-scène list and the intended RIASEC type of mini-game. Psychologists from the INETOP (French National Institute of Professional Orientation) and creators of a Holland model paper test (Vrignaud, 2006) are some of the resources involved in the design of this tool.

The Holland RIASEC hexagon has specific characteristics. If the test shows that the subject has a strong interest for a dimension, for example the Realist, he is more likely to have a strong score in types closely related to the Realist on the hexagon (here the Investigative and the Conventional), than with the opposite one (here the Social). We used this hexagon to evaluate the quality the mise-en-scène list elements.

For instance, in a mini-game related to the Realistic dimension, such as *Nice apple*, the closer an element is to the Realist type, the more it is marked as green. The closer it is to the opposite type, the more it will be marked as red. Based on the existing descriptions of the RIASEC types (according to Demangeon, 1984) and with the feedback from our experts, we were able to position each element of the list in relation to the appropriate dimension. With *Nice apple*, we proposed to replace the cursor with animated pruning shears. As the Realist dimension is related to outdoor contexts, jobs, and activities, the shears corresponded with the appropriate dimension and were classified as green. In other mini-games with other RIASEC type objectives, the color ranking changes accordingly. For instance, in the mini-game *Invasion of the ants*, the game is supposed to appeal to the Investigative type. The cursor is changed to a magnifying lens. Figure 6 shows the shifting of the ranking depending on the mini-game RIASEC intention.

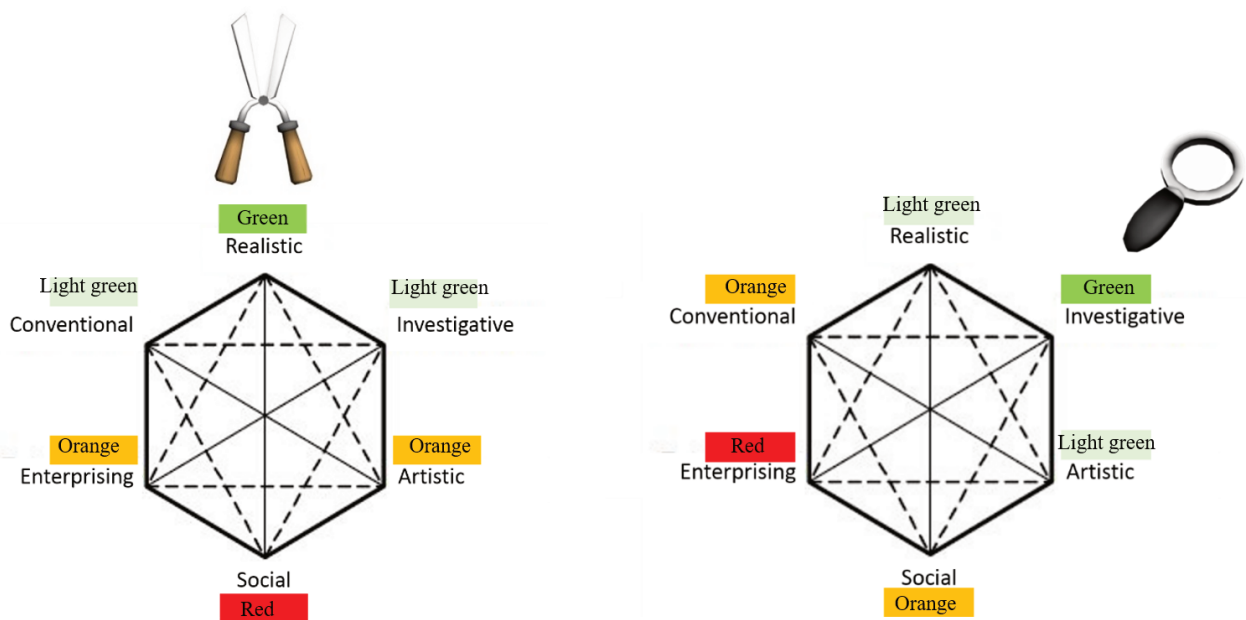

Figure 6. Examples of evaluation of in game elements for a Realist and an Investigative mini-games.

In table 2 you can see an extract of one of tables we used during production. The cells of the elements best linked to the targeted type are in green; the ones related to adjoining dimensions are in light green, the average quality link in orange; and the worst case, an element related to the opposite dimension, is in red.

RIASEC dimension	Mini-game	Cursor	Handled elements and interaction targets	Interactions feedbacks
R	Nice Apple	Secateurs	Apples	Animated leaves
I	Invasion of the Ants	Magnifying glass	Ants with and without food	Green mark
...

Table 2. Example of a table using the color code to flag the quality of the relation between a game element and the targeted dimension.

These evaluation tables describing various game elements were updated depending on the evolution of versions of the prototype and game design decisions.

We synthesized the evaluation of all the elements of the list into one table (Table 3). It serves as an indicator of the connection quality between the mini-game content and RIASEC dimensions. The signs “+” and “-“ are additions from the original table, due to the black and white printing of this chapter. The legend: “++” represents green, meaning the element matches the correct type; “+” represents light green, meaning the element matches with a closely related type; “-” represents orange, meaning the element matches with a nearly opposite type; and “- -” represents red, meaning the element matches with the opposite type. An empty cell signifies a neutral element.

Table 3 presents the results of this work as it was at the end of the first version of the prototype, just before the first test with the target audience. We were aware of some mismatches in the mise-en-scène. For instance, in its first version, *Nice apple* was not triggered by a non-player character representative of the type the mini-game was supposed to support. At the time, we did not have suitable design solutions to change that. In the *Nice apple* case, the limited number of characters we could set in the village was one of the causes for the mismatch. We were able to improve this in the first complete iteration of the game production, after the psychometrics tests.

Psychometric tests as an evaluation of the mise-en-scène quality

The original goal of the psychometric test was to evaluate if the game actually generated a player profile at least equivalent to the traditional paper/online questionnaires. Pierre Vrignaud (2012) commented on the results, citing the grading and ranking of items as the most promising among the many data collected during the play sessions. These items could also be used as an evaluation method of the relation between the intended RIASEC dimension of a mini-game and what is actually conveyed to the users: our rational mise-en-scène tool.

RIASEC dimension	Mini-game	Simulated activity	Gameplay action verbs	Objective	Cursor	Handled elements and interaction targets	Interactions feedbacks	Mini-game Environment	Non interactive animated element	Triggering place	Triggering Character
R	Nice Apple	++	++	++	++	++	++	++	++	++	-
I	Invasion of the Ants	++	++	++	++	+	++	+		-	++
A	Autumn fashion	++	++	++		++	++	++		++	++
S	Ms Petitpas shopping	++	++	++		++	++	++	++		++
E	Omelet	++	++	++		++	++	++	++	-	-
C	Classified!	++	++	++		++	++	++	++	++	++
R	Tile	++	++	++	++	++	++	++	++	-	-
I	Light	++	++		+	+	++	++			++
A	Photos	++	++	++	++	++	++				-
S	Take shelters!	++	++	++		++	++			++	++
E	Sand and sweat	++	++			++	++	++	++		+
C	Stock	++	++	++		++	++	+	+	+	+
R	Assembly	++	+	++		++	++	-		++	++
I	Chemistry set	++	++	++		++	++	++		++	++
A	Decoration	++	++	++		++	++	++		++	++
S	Reception	++	++	++		+	++	++	++	+	+
E	Promotion	++	++	++		++	++	++		++	++
C	Good seat	++	++	++		+	+	-	-	++	++

Table 3. RIASEC/game elements connection indicator synthesis.

Test context and protocol

In the JEU SERAI project, our psychometric experts used the external correlation method, comparing item aggregations to the results obtained by the subjects in reference to a classical test. They used the IRMR 3 (Rothwell, 1994) the French version of the Rothwell-Miller Interest Blank based on the Holland model. The main tool used to complete this comparison was the Bravais-Pearson correlation coefficient (Guardiola and Natkin, 2015).

140 people took the test between September 2011 and January 2012. 103 were students from the UPOND University, 37 were adults in career changes from the ARCNAM-Poitou-Charentes. A randomized half of the panel received the classical paper test first, then the game session; the other half in the reverse order. It took approximately 2 hours to complete the game and the questionnaire took less than 20 minutes. The participants were advised that the goal of the play was to establish a profile of professional interest. The tests were led by psychometric experts from the UPOND.

Test results

The following tables are examples of correlation coefficients produced during the analysis. The first uses the immediate grading of a mini-game upon completion (Table 4), and the second uses the ranking of the favorite mini-games per day (table 5). In each case, the correlation is established with the result of the answers to the reference paper test. The correlation is considered strong when over 0.4, medium when between 0.2 and 0.4, and weak when below 0.2.

The grey tinted cells highlight where we originally predicted the correlation would be, due to our intention/means rational design work. Each column shows one mini-game correlation result. Rows are the type of subjects given by their result on the paper test. In the column, the bold-italic value indicates where the correlation coefficient is actually the highest, sometime with other RIASEC type of subjects than the targeted ones. If there are several bold-italic values in the column, it means that there are several dimension-related high scores from the paper questionnaire that are close to the dimension we targeted in the mini-game (we considered the difference to be irrelevant if there was less than a 0.05 difference between the dimension scores).

Discussion

In his publication dedicated to psychometric results of the experiment, Pierre Vrignaud (2012) concluded that the correlations are congruent with the Holland model, but the correlations are weak or medium and the most are not statistically significant. By congruent, he means that a majority of the highest correlations per mini-game (bold italic numbers) correspond with the targeted RIASEC type (grey cells). So, even if the values are weak, we have the trace of a shift of correlation from mini-game to mini-game, which we believe is due to the *mise-en-scène* design.

There are two interesting facts related to the failures cases. First, the mini-games related to the type *Enterprising* mostly failed to correlate with their intended target. Second, either with the *Grading* or the *Ranking* items, there are at least medium correlations in the last group of six mini-games (Day 3).

LEARNINGS FROM JEU SERAI RESEARCH PROJECT

The positive aspect of the results can be interpreted as a product of the rational *mise-en-scène* approach. As seen in the Ubisoft examples, we set up intentions (here the RIASEC dimensions of the Holland model) and we rationally designed means to realize these intentions (here by using a list of means and a way to evaluate their pertinence to each dimension). It seems that most of the mini-games convey the RIASEC type they are supposed to communicate to the player, although also the failures have interesting consequences on the game design process.

The mini-games dedicated to the *Enterprising* type did not interest people of this type. This could be a potential issue for our rational *mise-en-scène*. One of the reasons for these multiple mismatches is the psychometric panel: people with a strong score in the *Enterprising* dimension were underrepresented which might have influenced the strength of results from this dimension for the entire test.

Another reason for the *Enterprising* failure seems to be in the design process itself. In the RIASEC Intention/ means table (table 3), some of the elements are easier to evaluate than others. The *simulated activity* of a mini-game can easily be compare to an activity in real life, already within the context

Day 1 Grading item	Nica Apple Realistic	Invasion of the Ants Investigative	Autumn Fashion Artistic	Ms Petitpas shopping Social	Omelet Enterprising	Classified! Conventional
R_IR	0.10	0.35	-0.12	-0.07	0.10	0.21
I_IR	0.13	0.30	0.21	-0.28	0.62	-0.15
A_IR	-0.27	-0.19	0.15	0.22	0.06	-0.38
S_IR	-0.29	0.11	-0.16	0.37	-0.07	-0.25
E_IR	0.15	-0.32	0.14	-0.06	-0.27	0.37
C_IR	0.02	-0.18	-0.11	-0.32	-0.33	0.35

Day 2 Grading item	Tile Realistic	Light Investigative	Photos Artistic	Take Shelters Social	Sand & Sweat Enterprising	Stock Conventional
R_IR	0.42	0.3	-0.3	-0.12	0.24	0.17
I_IR	0.29	0.35	-0.07	0.02	0.2	-0.16
A_IR	-0.15	-0.19	0.51	0.03	-0.08	-0.31
S_IR	-0.05	-0.11	-0.04	0.43	0.01	-0.28
E_IR	-0.16	0.01	-0.29	-0.2	-0.37	0.16
C_IR	-0.03	0.18	-0.47	-0.32	-0.08	0.44

Day 3 Grading item	Assembly Realist	Chemistry set Investigative	Decoration Artistic	Reception Social	Promotion Enterprising	Good seat Conventional
R_IR	0.22	0.08	-0.05	-0.14	-0.03	0.05
I_IR	0.27	0.14	0.33	0.25	0.25	0.32
A_IR	-0.10	-0.20	0.21	0.17	0.32	0.02
S_IR	-0.26	-0.17	-0.21	0.26	-0.26	-0.30
E_IR	0.25	0.16	0.06	0.16	0.03	0.11
C_IR	0.09	0.15	-0.29	-0.16	-0.05	0.04

Table 4. Correlation between the Grade item and the best scoring dimension from the paper questionnaire.

of a RIASEC dimension. A clear feature like the cursor shape can obviously belong to one of the dimension stereotypes (the shears correspond with the Realist dimension, the magnifying lens with the Investigative, the brush with the Artistic). But an element like “Gameplay verb” is subject to interpretation.

After the psychometric test results, we had a closer look at the elements of the Enterprising mini-games. In the *Promotion* mini-game, the player manages a team of ticket sellers (inhabitants of the village) who promote upcoming events at the annual village fair. In the first version of our evaluation, while designing the mini-game, we identified actions like “choosing the seller and the type of ticket to sell”. They seemed relevant to the Enterprising type.

The Figure 7 is a screenshot of the *Promotion* mini-game: it is designed like a board game where the player moves the sellers to different locations (in front of a museum, at the exit of a sports stadium, etc.) to sell different types of tickets (concert, exposition, match, and so on). Also, some sellers are

Day 1 Ranking item	Nica Apple Realistic	Invasion of the Ants Investigative	Autumn Fashion Artistic	Ms Petitpas shopping Social	Omelet Enterprising	Classified! Conventional
R_IR	0.28	0.18	-0.11	-0.29	0.01	-0.03
I_IR	0.33	0.00	-0.11	-0.33	0.15	0.00
A_IR	-0.13	-0.03	0.26	0.16	-0.13	-0.21
S_IR	-0.25	-0.02	0.03	0.24	-0.16	0.15
E_IR	-0.08	-0.08	-0.06	0.04	0.14	0.05
C_IR	-0.04	-0.06	-0.03	-0.10	0.09	0.16

Day 2 Ranking item	Tile Realistic	Light Investigative	Photos Artistic	Take Shelters Social	Sand & Sweat Enterprising	Stock Conventional
R_IR	0.16	0.23	-0.19	-0.14	-0.02	-0.01
I_IR	-0.03	0.36	-0.18	-0.01	-0.02	-0.13
A_IR	-0.12	-0.09	0.27	0.10	-0.14	-0.07
S_IR	0.03	-0.08	0.05	0.13	0.00	-0.14
E_IR	0.07	-0.14	0.05	-0.13	0.13	0.05
C_IR	0.05	-0.07	-0.15	-0.21	0.14	0.28

Day 3 Ranking item	Assembly Realist	Chemistry set Investigative	Decoration Artistic	Reception Social	Promotion Enterprising	Good seat Conventional
R_IR	-0.02	0.06	-0.02	-0.18	-0.02	0.16
I_IR	0.02	-0.04	-0.14	-0.11	0.14	0.12
A_IR	0.05	-0.10	0.14	0.05	0.01	-0.13
S_IR	0.01	0.05	-0.01	0.16	-0.02	-0.19
E_IR	-0.17	-0.01	0.03	0.22	0.04	-0.12
C_IR	0.02	0.06	0.00	-0.03	-0.04	0.00

Table 5. Correlation between the Ranking item and best scoring dimension from the paper questionnaire

more competent at selling particular types of tickets. So the player spends his time trying to optimize the combination of location, type of tickets, and type of seller to improve a real-time ticket selling rate. However, we seemed to have overlooked the fact that the player is constantly experimenting with these associations and their impacts on the selling rate. From this point of view, it is less surprising to see that the Investigative type of participants are the one who correlate the most with the ranking item and have a medium correlation with the grading item.

The mean called “Gameplay action verbs” was not well enough defined at the beginning of the process. They were sensible to be rationally evaluated. In this mini-game the other elements remain positive to the targeted RIASEC type. This raises the question of the weight of different means or elements to convey the intention. Does the “Gameplay action verb” prevail?

There are cases of other mini-games failing their correlations, so certainly failing to attract their main target group. Two of the last day mini-games did, but with another non-accurate element, the



Figure 7. Screenshots of the Promotion mini-game.

mini-game environment. They were designed and produced at the end of the production, in a rush period, and certainly with less attention than the previous ones. From the data we have, we cannot conclude that the environment element is the main issue. In other games, such as *Photo* or *Take shelters*, environments are evaluated as neutral, not tainted by one of the RIASEC types. These games had positive correlations with the desired type of participants.

JEU SERAI game design experimentation also provides interesting outcomes regarding the significance of mise-en-scène means. We can demonstrate that the nature of the gameplay activities and the mini-game environments have an impact on reaching the psychological dimension objectives of certain mini-games. However, we cannot state that the impact of a kind of element is valid for all RIASEC intentions. In other words, we can suppose that for certain RIASEC types “Gameplay action verbs” are a critical means, but another RIASEC type may be more sensible to simulated activity or the nature of the interaction feedback. In the field of games for psychological profiling, JEU SERAI provides a starting point for better game design processes.

From the perspective of the entire production, there are two factors related to the subjective aspect of game design tasks to take into account. The first is the game designers’ capability to propose suitable content to fit the intention. In the case of a multidisciplinary serious game production like JEU SERAI, this point is partly addressed by the involvement of vocational guidance experts in the design process and the content review. The second is the nature of the indicator that evaluates the quality of the link

between means and intention. In JEU SERAI, the literature about the different RIASEC types enables the design of indicators, as summed up in Table 3.

We suppose that the rational *mise-en-scène* approach can help in other game design contexts, in particular in the health and educational fields. What is your intention and what explicit means are you using to support it? This approach creates a better understanding of the elements game designers are playing with to impact the player experience and the real life expected benefit, such as psychological profiling in JEU SERAI.

CONCLUSION

Mise-en-scène is a part of the game design process, either conscious or not for the game designer. Here we have provided a glimpse of this process in an attempt to explain it within both industry and research contexts. The use of a *rational mise-en-scène* seems to have a positive influence on the game design process and the final product, allowing more control over the player experience. The psychometric results from the JEU SERAI experimental game project support this idea. With this chapter we hope to offer the first scientific evidence of the impact of the *mise-en-scène* process, linking intention and means, on the player.

The notion of means of *mise-en-scène*, as used in other media, is susceptible to subjective interpretation. Providing a definition of each of the elements composing the list of means will not always solve this issue. For instance, the “gameplay action verbs” element used in JEU SERAI obviously needs a better framework. The lack of strong models or references to gameplay in literature is certainly one of the reasons for this weak definition. The exploration of an exhaustive list of means for the *mise-en-scène* of games, and the elaboration of their definitions, could be a next step in our work.

In addition to the benefit for serious game projects, within an academic environment, this formal game design approach can also be used as a pedagogical tool to train students and to practice game analysis.

ACKNOWLEDGEMENTS

To Ubisoft to allow the publishing of extracts of game design research documents, to Caroline Jeanteur for her help, and to Curtis Maughan for proofreading.

BIBLIOGRAPHY

Bogost, I., 2007. *Persuasive games*. MIT press.

Bordwell, D. and Thompson, K., 2003. *Film art: An introduction*. 7th ed. McGraw–Hill.

Demangeon, M., 1984. *Intérêts, valeurs, personnalité en classe Terminale*. INETOP.

Guardiola, E. and Natkin, S., 2015. Game Design methodology for generating a psychological profile of players. In: C.S., Loh, Y. Sheng and D. Ifenthaler, eds., *Serious games analytics, methodologies for performance measurement, assessment, and improvement*. Springer.

Guardiola, E. and Natkin, S., 2010. Player’s model: Criteria for a gameplay profile measure. In: *Proceeding ICEC 2010, Seoul*. Springer.

- Hillier, J., 1985. *Cahiers du cinema: Volume I: The 1950s. neo-realism, Hollywood, new wave*. Routledge.
- Holland, J.L., 1966. *The psychology of vocational choice. A theory of personality types and model environments*. Blaisdel.
- Juul, J., 2005 *Half-real*. MIT press.
- Nintendo, 2008. *Animal crossing: Let's go to the city* [game]. Nintendo.
- Rollings, A. and Morris, D., 2000. *Game architecture and design*. Scottsdale: Coriolis
- Rothwell, J., 1994, *IRMR 3, Inventaire d'intérêts professionnel de Rothwell-Miller (RMIB 3, Rothwell-Miller Interest Blank)*. ECPA—Pearson.
- Schell, J., 2008. *The art of game design: A book of lenses*. Burlington: Morgan Kaufmann.
- Swink, S., 2009. *Game feel, a game designer's guide to virtual sensation*. Burlington: Morgan Kaufmann.
- Ubisoft, 2005. *Peter Jackson's King Kong* [game]. Ubisoft.
- Ubisoft, 2006. *Ghost recon advanced warfighter* [game]. Ubisoft.
- Vrignaud, P. and Cuvillier, B., 2006. *HEXA3D. Questionnaire d'évaluation des intérêts*. Editions du centre de psychologie appliquée.
- Vrignaud, P., Loarer, E., Boy ,T., Dosnon, O., Natkin, S., Guardiola, E., Leblanc-Sitaud, C. and Cuvillier, L., 2012. Are serious games a reliable approach to the assessment of vocational interests? In: *8th Conference of the ITC: Modern advances in assessment: Testing and digital technology, policies and guidelines*, Amsterdam.

CHAPTER 7

GAPS OF UNCERTAINTY

A CASE FOR EXPERIMENTATION IN SERIOUS GAME DESIGN FRAMEWORKS

NIELS QUINTEN, STEVEN MALLIET AND KARIN CONINX

Using serious game design frameworks, designers can more rigidly and faster proceed through a serious game design process by following predefined design rules or heuristics. Deen and Schouten (2011, p.344), for example, introduce a six step framework in order to increase player motivation in serious games, and propose heuristics such as “explicitly communicate the learning regulations to players” and “use progressive feedback.” Such heuristics are undoubtedly valuable, yet they simultaneously discount the individuality of design situations. They risk formalizing the serious game design process to a degree where design becomes only following rules, instead of exploring novel design possibilities. In this chapter, we argue that design frameworks should incorporate a self-critical experimental step in which designers momentarily forego the framework’s rules in order to reveal unexpected design possibilities. A case study of a completed PhD project on the design of physical rehabilitation games (Quinten, 2015) is presented in order to discuss the advantages and disadvantages of this approach.

THE ROLE OF EXPERIMENTATION IN DESIGN

In this text, we seek to examine the role of experimentation as a critical component of serious game design frameworks. Before we address this role however, it is critical to first understand how experimentation relates to the practice of design itself. We believe Schön’s (1983; 1992) seminal theory of the reflective practitioner provides a solid base for this understanding. Though this theory does not fully reflect the complexities of real-life design scenarios, it accurately peers into the basic tasks of what designers do. As such, Schön (1992, p.11) describes design as a reflective conversation with the materials of a design situation, in which he observes that the designer constructs design solutions and simultaneously “invents the moves by which he/she attempts to find [those] solutions”. This happens through a repetitive pattern of seeing-moving-seeing as displayed in Figure 1, in which each segment of this pattern reflects a fundamental action required to progress through the design process.

To explain this pattern, Schön (1983; 1992) describes a situation where an architectural design student under supervision of her teacher is presented with a specific design scenario. The design goal in the scenario is to create a teaching space with the use of six classroom units. As a first step, seeing in the box on the left in figure 1, the student sees or inspects the design scenario and the materials (classroom units) at hand. This inspection not only concerns the visual registration of information, but, more importantly, the active construction of meanings relating to the scenario and the materials. The student identifies a (subjective) problem in the design scenario: the units are too small for the purpose of teaching. In an attempt to solve this problem, she continues to the second step of

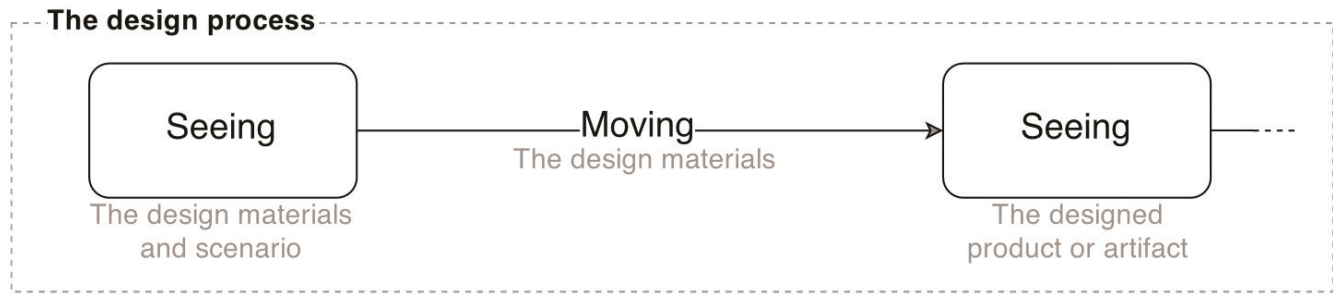

Figure 1. The seeing-moving-seeing pattern according to Schön (1983; 1992).

moving—displayed in the between the two boxes of seeing—and changes or rather reshapes the classroom units. In the example, the student rearranges the classroom units into attached spaces, aiming to create a larger total space. The student, thirdly, reflects on the changes made again by seeing, the box on the right in figure 1. If the new arrangement does not address the problem as expected, the second and third steps are repeated until a satisfied design solution has been reached.

Schön's (1983; 1992) theory of the reflective practitioner is a clear departure of the impression that designers ideate in advance of executing the design itself. If designers do not interact with the materials during the ideation phase, they may become trapped in their own thinking by disassociating themselves from the design situation. Schön's concept of design is thus rather a process in which both the designers and the materials perform a dialectical process in which they inform one another of the possibilities and constrains of the design situation. Critical within this concept is that the reflective conversation should not be viewed at from a distant third-person perspective in which the conversation has already unfolded. Instead, in order to fully comprehend the intricacies of the design process one must imagine the conversation from the designers' point of view. As in a real conversation, it is not determined in advance which sentences are going to be said at what time, the sentences are rather constructed during the conversation on the basis of others their responses.

GAPS OF UNCERTAINTY IN DESIGN

Following from its constructive nature, design is thus not a process where one linearly moves from point A to point B, but rather whereby one moves repetitively forward and backward again, exploring different pathways in a design space (Kruger and Cross, 2006). Schön (1992) asserts that the seeing-moving-seeing pattern permits designers to “recognize more in the consequences of their moves than they have expected or described ahead of time.” Schön refers to the fact that the created artefact allows designers to gain knowledge they did not have before it was created. This is done through the act of reflection (Schön, 1983; 1992) or, in other words, by looking back on the design result in relation to the initial configuration. As is seen in figure 2, this reflection is on the designed artefact, which may contain materials that behaved in an unpredictable manner. Reflection is vital in design research because the material configuration is, to a degree, unpredictable (Schön, 1983; 1992). The act of moving involves creativity and thus may contain unexpected outcomes (Scrivener, 2000), and reflection allows designers to see this unexpectedness and respond accordingly in subsequent phases (Goodman, Stolterman and Wakkary, 2011).

To aid designers in this process of exploration, prototypes can be used. Lim, Stolterman and Tenenberg (2008, p.7:2) define prototypes as “the means by which designers organically and evolutionarily learn, discover, generate, and refine designs.” Prototypes can be considered as low

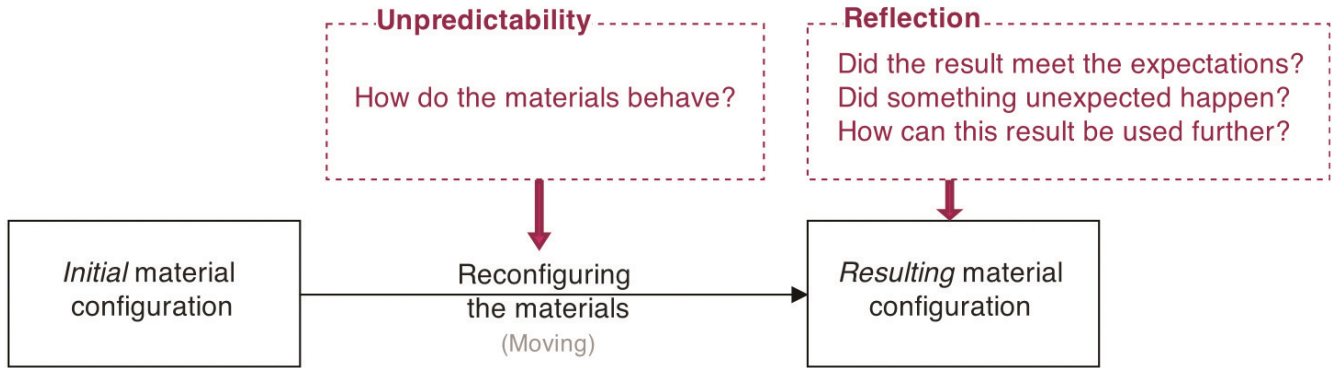

Figure 2. Reflection and unpredictability in the design process.

fidelity artifacts used to explore specific parts of the design space while leaving other parts (perhaps momentarily) aside. Lim, Stolterman and Tenenberg (2008) argue that prototypes are often regarded as means to evaluate designs in a resource-efficient manner, but more importantly, to stimulate the generation of design solutions. In this regard, the term prototypes is not understood as an early product model, but more as processes similar to sketching on a piece of paper in order to generate ideas fast and inexpensively (Agustin, et al., 2007). Of course, if we follow Buxton's (2007) discussion on prototypes and sketching, we cannot actually interchange prototypes and sketching. However, the beauty of Lim, Stolterman and Tenenberg's contribution is in fact that they do translate the exploratory and idea generating nature of sketching to other materials than pen and paper. As a result, they open a whole new range of possibilities for prototyping, as different materials have the capacity to generate different ideas based on that material (Lim, Stolterman and Tenenberg, 2008). In this way, Buxton's main component of sketching even becomes a prerequisite for prototyping: employing the ambiguity of the materials (Buxton, 2007) to discover opportunities and problems not thought of before (Edelson, 2002). Thus, in design research, prototypes serve as a material catalyst for inspiration during the exploration process.

TACKLING GAPS OF UNCERTAINTY THROUGH EXPLORATION

According to the constructivist philosophy, "[r]ealities are apprehendable in the form of multiple, intangible mental constructions [which] depend for their form and content on the individual persons or groups holding the constructions" (Bryman, 2012, p.111). It holds that people constantly (re)interpret the world and, as a result, reshape the meanings of and the perspectives on how that world works (Bryman, 2012). Important within this consideration is that there can exist multiple realities, as individuals and groups of people can interpret the world differently through their interactions with it. The goal of research within this paradigm is not to seek out a single objective 'true' reality, but to create a deeper and more informed understanding of how these diverse realities come about and work together (Guba and Lincoln, 1994).

The aim of design research in this sense is to generate, or construct, a (part of) particular reality through the act of designing (Fallman and Stolterman, 2010; Eckert, Stacey and Clarkson, 2003). Thus, following the constructivist philosophy, it is vital to create a deeper and more informed understanding of that particular reality or, in terms of Schön (1983; 1992), Cross (1982; 2006), and Frayling (1993), of the design process and its resulting artefact. The act of exploration can thus be considered as a manner to move towards a future which could not have been envisioned in advance.

This emphasis on the future is a critical aspect of design research (Stolterman, 2008). Designers do not direct their attention towards the now, but towards the construction of new futures (Goel and Pirolli, 1992). However, they do not know what they can or should create before they have actually created it. Therefore, through the act of design, and building upon what exists today, designers explore parts of the future in the now. This exploration does not necessarily result in a specific future, but presents concrete alternatives, and as such it can contribute to a more preferred one (Gero, 1990; Forlizzi, Zimmerman and Stolterman, 2009).

The exploration of a design space is not easy because of the design complexity and the insights and creativity required of the designers (Dorst, 2008). These elements submerge designers in the now and inhibit them from working towards new futures. Consequently, designers need to actively explore what is possible and desirable to create (cf. Norman and Verganti, 2014). As Schön (1992, p.11) observes, the designer constructs solutions and simultaneously “invents the moves by which he/she attempts to find [those] solutions.” In this fashion, designers gradually discover the requirements, opportunities and limitations of a particular project (Ho, 2001), and direct both the problem and the solution towards one another (Dorst and Cross, 2001).

GAPS OF UNCERTAINTY IN CURRENT SERIOUS GAME FRAMEWORKS

In the previous section, we argued that design processes contain gaps of uncertainty. These gaps arise between the phases of *looking* at the design situation and *acting* on the design situation, during which time designers may manipulate designs in unexpected and innovative manners. As such, uncertainty in this sense should not be considered a negative aspect of design. Instead, uncertainty is always present and represents opportunities to create more fitting or novel designs.

In the following section, we argue that the developers of serious game design frameworks often fail to include these gaps of uncertainty in favor of depicting more predictable frameworks. These more predictable frameworks suggest increased time and cost efficiency as well as less expertise needed to use them. While these are undoubtedly critical components of a successful design project, the avoidance of the basic design component of uncertainty might likewise create missed opportunities that may otherwise positively influence the design outcome. After discussing these serious game design frameworks, we describe how we welcomed the gaps of uncertainty within our own design process and which advantages and disadvantages it brought with it.

THE RELEVANCE OF SERIOUS GAME DESIGN FRAMEWORKS

Within the field of serious game design, one of the major difficulties is combining the structure of digital games with the structure of education or training. In response to this difficulty, design researchers wish to generate information on how to design serious games in order to develop these games with reduced cost, time, expertise, or effort. One popular manner to address this issue is by developing design frameworks that guide designers through the design process. While these may be in the form of practical tools (e.g., the Unity3D [Unity Technologies, 2016] game engine is in itself a framework), we here wish to only go deeper into the theoretical frameworks created by researchers similar as in our own project (Quinten, 2015). The underlying assumption about these frameworks is that parts of a particular design process may be generalizable to other design projects as they contain similar challenges, situations, and solutions (Gericke, 2011). As is addressed in more detail below, this assumption needs to be balanced with the idea that each project also needs gaps of uncertainty.

Game researchers such as Prensky (2001) and Gee (2004) began to popularize the notion of game based learning early in the 2000s. Van Eck (2006) then wrote a seminal piece describing that as the field had finally caught attention, it should deliver what it had promised (an integrated combination of education and training, and games). This view is reflected in the works of, for instance, Gunter, Kenny and Vick (2006) who developed a standard formal design paradigm which merged educational and training theories and game design processes in order to build effective and interesting educational and training games. Important to highlight here is that researchers began call for standardized approaches through which all educational and training games could eventually be developed.

CURRENT SERIOUS GAME DESIGN FRAMEWORKS

Gunter, Kenny and Vick (2006) construct their framework by analyzing three existing educational theories and map these onto practices of game design. The result is a nine-step process in which they provide suggestions on how design researchers can combine instructional content with video games. For example, step one focuses on game design by suggesting to insert dramatic elements that gain the players' attention, while step two emphasizes instructional design by saying this attention can be applied to underscore the didactic choices to players. In relation to the seeing-moving-seeing of Schön (see above, The role of experimentation in design), Gunter, Kenny and Vick (2006) give suggestions on how to *move* from *seeing* a specific problematic situation (e.g. a separation of education/training and games) to *seeing* this situation resolved (e.g., education or training and games integrated together). In other words, this type of framework thus predefines the moving steps for creating educational/training games. A number of other researchers create same kinds of frameworks as Gunter, Kenny and Vick (2006). Deen and Schouten (2011, p.344), for example, introduce a six step framework in order to increase player motivation in serious games, and propose heuristics such as "explicitly communicate the learning regulations to players" and "use progressive feedback." Clearly, these investigations offer a valid and practical contribution to the area of educational/training games. Nevertheless, if these frameworks are interpreted as only following a set of rules, users of the framework might in practice actually miss opportunities in combining education or training with digital games. As seen in the section above, the role of experimentation in design, the steps of moving encourage designers to explore and innovate, which might be mitigated if the steps become predefined.

The observation that frameworks can hinder exploration is not entirely new. In his investigation into what designers know, Lawson (2009) examined a number of (non-game related) design frameworks and concluded frameworks are often too general or too detailed to reflect actual design practice. Lawson argues that design projects can involve a wide variety of designers and stakeholders whom all share different approaches and goals depending on the project. In view of this, frameworks may thus not translate from one situation to the other as one expects. Similarly from a game design perspective, Dormans (2012) argues that frameworks are not always accepted in the game industry, as some designers believe they restrict the productivity and creativity of the design process. Dormans here hints at the uncertainty factor in Schön's (1983; 1992) theory of design and that game designers actually wish for such uncertainty in order to design. Having said this, Dormans simultaneously underscores the relevance of frameworks provided they are used in the proper context.

Within the sphere of educational and training games, researchers have addressed the above issue with different types of frameworks. For example, the goal, audience, game and environment (GAGE) model (Lepe-Salazar, 2015) does not focus specifically on a step-by-step guideline of how to design an educational game. Rather, it acknowledges the complexity of game design and presents a set of

concerns designers need to take into account (e.g., *who are the stakeholders* and *what is the goal of the game?*). One main advantage in this approach is that there is no prescribed step-by-step way of designing and designers thus have more creative freedom. Of course, one major disadvantage of this approach is that it requires a lot of design expertise to combine these concerns. Conversely, Roungas and Dalpiaz (2015) argue that most educational frameworks fail to structure the design process according to game design conventions. They therefore propose a *digitalized game design document* (GDD) tool that could aid researcher to design educational games. Although their evaluation of the tool was inconclusive, the idea shows promise as it would help design researchers iterate over each game element in sequence and manner they wish. Nevertheless, the disadvantage again would be that a lot of expertise would be needed to tie together all these game elements.

Winn (2009) makes an interesting contribution by extending the existing and popular *mechanics, dynamics* and *aesthetics* (MDA) framework (Hunicke, Leblanc and Zubek, 2004) in order to include a layer of learning on top of the normal game layers (storytelling and gameplay). However, his resulting *design, play* and *experience* (DPE) framework is perhaps foremost an analytic tool or a language tool between the different stakeholders in a serious game design process. As such, it highlights the links between game design and instructional design on the same abstract and useful level as the popular MDA framework, but it does not say much about what to do practically with these links as it is up to the designers to fill them in.

Hung and Van Eck (2010), on the other hand, focused on the types of gameplay that would fit best with specific learning goals and objectives. For example, starting from Jonassen's (2010) topology of problem types, Hung and Van Eck suggest that logical problems might best be solved in an *adventure puzzle* type of game, while decision-making might best be practiced within action games or strategy game. The model itself goes into more detail as to which specific features (declarative, high-order thinking, etc.) would be relevant in each choice. The model could be very useful in the beginning of the design process, where one can decide which type of game they will build in order to accommodate the learning objectives.

Finally, Kelle, et al. (2011) provide an insightful discussion on the standardization of educational game design. Specifically, they analyzed two approaches of creating frameworks and models in educational game design. The first approach appropriates learning models as a foundation and then adapts the game components to these models. Kelle, et al. (2011) conclude that the educational aspects in these types of frameworks can often be easily repurposed in other projects, yet also often lack an interesting resulting game experience. The second approach was the opposite, starting from game design characteristics and adapting these to the educational and training setting. While Kelle et al. argue this often results in a more convincing game experience, it conversely lacks the reusability of the educational aspects for other projects. They conclude that more harmonization is needed between both perspectives.

We conclude that educational game design frameworks often provide a good guidance during the design process, yet often do not take fully into account the importance of uncertainty in this process. We believe that in order to enjoy both clear guidance as well as uncertainty, there should be more focus on creative experimentation within the steps of a framework. We perceive that in many of the discussed frameworks the balance is currently directed towards filling in the gaps of uncertainty, while we believe we should sometimes replace this by helping designers navigate through the uncertainty in order to find the solution that befits their particular project.

THE EXPERIMENTAL SERIOUS GAME DESIGN FRAMEWORK

In this section, we present the *experimental serious game design framework*. This framework is one of the results of a PhD research project on the creative design of physical rehabilitation games (Quinten, 2015). The aim of this project was to explore the concept of physical rehabilitation games primarily from the perspective of the game designer. More specifically, our goal was to explore how a rehabilitation game style could encompass the particular characteristics of physical rehabilitation exercises as well as stroke and multiple sclerosis patient disabilities in the medium of digital games. In order to address this issue, four digital game prototypes were developed, tested accordingly, and reflected upon. The *experimental serious game design framework* presented below encompasses the rationale and goals of these prototypes in four phases, and has a particular focus on experimentation. Each phase is presented in the same structure: a short introduction which explains why we believe the phase was necessary and the general rationale behind it, then a clarification of how we aimed to address the issue presented in the introduction, and finally what the actual result of the phase was. Where relevant, we also added information on how we evaluated each phase, as evaluation is a critical factor in serious game design.

PHASE 1: SELECTING PRELIMINARY GAME ELEMENTS

In research on training games, researchers generally first draw a clear outline of the literature on a theoretical level. This outline provides information on the relevant issues and components within the field. Yet, it often does not provide practical design directions based on the particular features of the project. We therefore propose that preliminary elements should initially be defined in the design of training games (cf. the notion of a primary generator [Darke, 1979, cited in Lawson, 1990; Cross, 2006]). These elements assist to guide and structure the formation of the succeeding design process. To be clear, preliminary elements are not the training goals or characteristics, but rather elements that reflect the core idea of how the game will be developed. For example, in our project the close integration of educational characteristics and the digital game world was critical. Through the development of and reflection on an early game prototype, we explored which preliminary game elements would reflect this core idea.

Approach

Based on the works of Prensky (2001), Gee (2004), and Van Eck (2006), we shifted our initial focus of creating *fun* rehabilitation games to creating well-integrated rehabilitation games. Isbister, Flanagan and Hash (2010, p.2043) state that learning games need to contain *deep content*, referring to content that is closely integrated into the structure of a game and can consequently be experienced as an integral part of the game. As a detailed description of our rationale can be found elsewhere (Quinten, Malliet and Coninx, 2015), it is important to note here that this helped us avoid developing only from a training perspective or game design perspective. Instead, finding a common ground between both worlds became our main goal in this prototype.

Of course, there are certain rehabilitation characteristics that eventually need to be included to deliver a successful rehabilitation. Our approach was thus to define these characteristics (see Table 1) and then generate three game concepts which we believed took these characteristics into consideration. Out of these three concepts, one concept was developed into a functional game prototype named *Flowers* (see Figure 3). In this game, patients grow and maintain flowers by performing simple rehabilitation exercises and can later display these flowers in a community garden. The goal of the

Rehabilitation exercises	Impairments	Contextual Factors
Horizontal motion	Reduced dexterity	Multiple sessions
Vertical motion	Visual difficulties	5-10 minutes of play time
Circular motion	Reduced memory	Sitting position
	Slow cognitive processing	
	Play with worse hand	
	No use of fingers	

Table 1. The rehabilitation exercises, patient impairments and contextual factors relevant to the project

game is to be creative and keep the flowers as healthy as possible, which is directly affected by how well the predefined exercises are performed. Each time players perform a task they receive visual, textual, and acoustic feedback as well as points. They automatically collect the points in a progress bar, and can thereby unlock new levels which include new types of flowers, colors and even new virtual spaces to plant seeds.

In line with the theory of design research (e.g., Schön, 1992; Cross, 2006), we reflected on our own design practice and process based on this prototype, and used these insights to uncover the rationale underlying the design decisions we made. This reflection was intended to support the discovery of possibilities and constraints in the design space (Edelson, 2002) which we hoped to translate into preliminary game elements. It was not our intention here to uncover all possibilities and constraints regarding our aim to create a common ground, but to expose some that could be useful in the subsequent design process. As such, we defined two preliminary elements we believed would be important:

1. use game mechanics (rather than narrative, visuals, etc.) to connect real-life exercises with virtual actions
2. avoid that unforeseen and unwanted genre conventions slip into the design process and conflict with the abilities of potential players (Quinten, Malliet and Coninx, 2015).

Result

Preliminary game element 1: use game mechanics (rather than narrative, visuals, etc.) to connect real-life exercises with virtual actions. Reflecting on *Flowers*, we noticed that game mechanics are a relevant link between the rehabilitation world and the virtual world, similar to the relevance of game mechanics in general educational games (Lacay and Casey, 2011). For example, *Flowers* includes three main mechanics: planting seeds, growing and healing plants, and coloring flowers. Game mechanics encompass several properties such as actions, attributes, and dynamics which, accordingly, mirror rehabilitation therapy features such as exercises, parameters, and the situational context. The rehabilitation motions as well as their parameters have been implemented in the game actions the player performs and, consequently, in the attributes of these actions. The notion of a common ground is reflected in the mechanics of the game as they link the actions in the virtual play environment to the rehabilitation exercises in the real world on multiple levels.

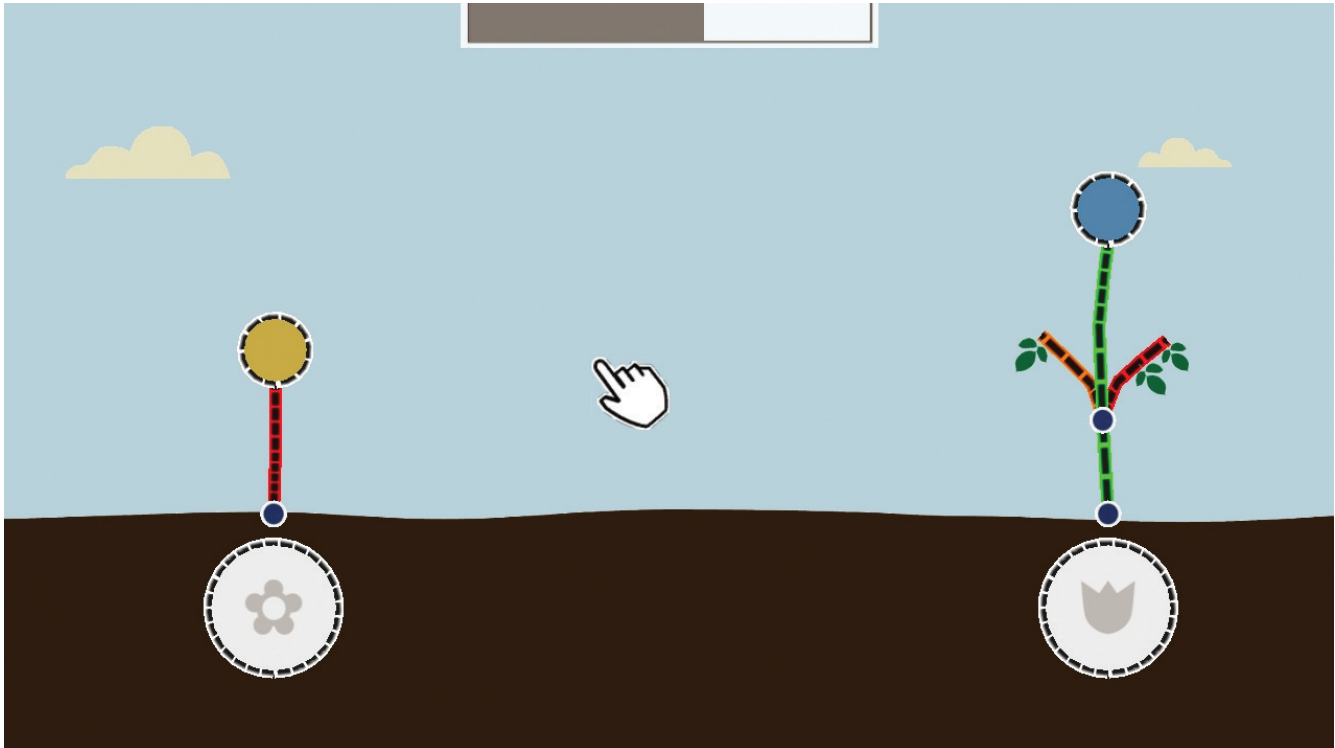

Figure 3. A screenshot of the game prototype *Flowers* in which players can trace lines in order to create a flower garden.

Preliminary game element 2: avoid that unforeseen and unwanted genre conventions slip into the design process and conflict with the abilities of potential players. In the concept phase, we spent attention on patient impairments (see table 1) by for instance using simple graphic representations. In spite of these precautions, the resulting prototype still included unwanted elements of visual and gamic¹ complexity which could not be removed as they were an essential part of the prototype's game genre. For example, an important part of construction and management games such as *Flowers* is the interface of the game which needs to communicate the underlying game world to the player (cf. Adams, 2009). This communication is often done through inventory systems that allow players to store and retrieve virtual items when appropriate, thereby avoiding the need to always have these items at hand (i.e. comparable to a real-life backpack). However, such inventory systems contain many small, selectable items, which increase the visual complexity of the screen as well as the difficulty of the hand-eye coordination needed. While we attempted to build the inventory in different manners, a conventional inventory system seemed one of the better solutions in the end for this concept, despite of its potential conflict with the abilities of potential players.

PHASE 2: PRELIMINARY GAME ELEMENTS CAN CATALYZE THE EXPLORATION OF DESIGN POSSIBILITIES.

The previous prototype helped us define preliminary elements that embodied our aim to integrate the rehabilitation world and game world. Unfortunately, these elements did not bring us much closer to actually creating a rehabilitation game. Because our game *Flowers* exhibited some fundamental issues (see preliminary element 2), we decided to create a new prototype that would take root in

1. We follow Kirkpatrick's (2011) use of the term gamic in order to highlight gameplay as a quality of games, in the same way games have, for example, visual, acoustic or haptic qualities.

a combination of both preliminary elements and avoid these issue. Consequently, the goal for the second prototype was to retain the element of game mechanics while removing as many genre conventions as possible. We approached this goal from an experimental point of view, meaning that we did not constrain ourselves to any rehabilitation characteristics, nor playability and user experience issues. The core goal was to embody the preliminary elements. With this in mind, the resulting prototype may appear a priori unsuitable as it fails to integrate specific rehabilitation characteristics and perhaps not even being playable. This observation is correct, yet this phase is only to further delineate the design space and reveal an overall design direction. In the next phase of the framework the prototype is adapted to specific constraints.

Approach

In order to achieve the goal of retaining the element of game mechanics while removing as many genre conventions as possible, we decided to reverse the typical game design approach according to which game elements are gradually added to a game concept (cf. Fullerton, 2008). We took our inspiration from abstract minimalist art and removed as many game elements as possible from an existing game while retaining its core game mechanics. Our focus was on the pictorial and fictional qualities of the game as well as the quantity of game elements in order to reduce the cognitive and physical load that is imposed on rehabilitation patients. Specifically, we deconstructed and minimalized the game world of the commercial game *Quake live* (Id Software LLC, 2010) gamically and visually. We chose *Quake Live* for its prominent tactile aesthetic (Smith, 2012) which we believed could potentially suit well the tactile nature of rehabilitation therapy. As there was no predefined method available for the abstraction and minimalization of entertainment games, we experimented with and changed the game's form. Specifically, we removed most of its genre conventions (e.g. using a gun to shoot) and represented the rehabilitation exercises through only its remaining core mechanics. While the limited space here prevents us from going into detail about this process, the important point is that we adapted the game form to our preliminary game elements through trial and error, rather than simply integrating the features presented in Table 1 into the existing game form.

Result

This resulted in the game prototype *Two circles and a line* (see figure 4). Compared to *Quake live* (Id Software LLC, 2010), the resulting game contains considerably less representational qualities to exteriorize the formal identity. In a similar fashion the spatial qualities of *Quake live* were significantly reduced in the experimental design process. The objects and challenges of the game were abstracted and minimalized. For example, opponents were represented by red cubes and moved on a constraint path instead moving freely in a 3D environment. Overall, the prototype contained less genre conventions yet still had simple mechanics which could represent the rehabilitation exercises.

Evaluation

Though the resulting game met the prototyping goals, the ensuing real-life arm movements were too restricted for rehabilitation and the gameplay was difficult to understand. Nevertheless, two informal play sessions were held with a number of rehabilitation therapists to assess whether the game and its abstract minimalist style warranted further development and testing with actual patients. The first session was organized during the development process, and revealed that the therapist had a generally positive impression of the game in relation to the goal of the prototype. She stated that the game

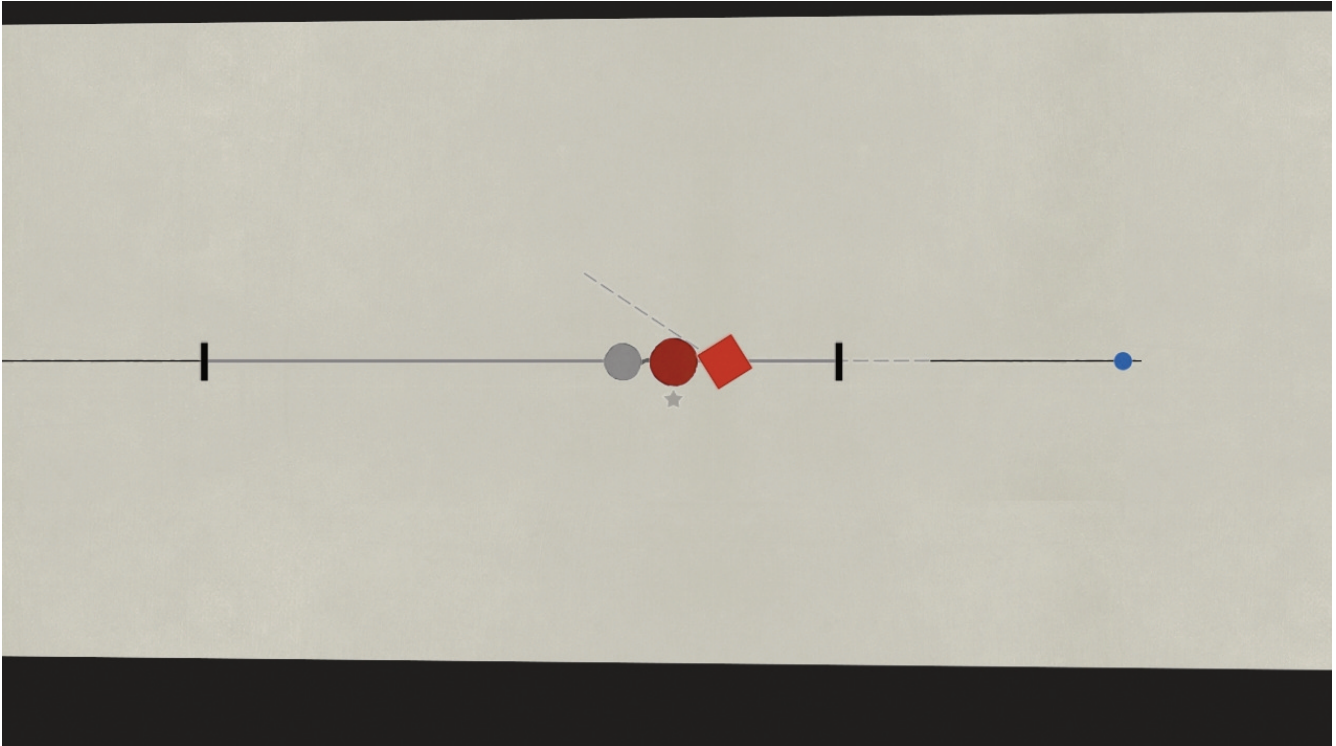

Figure 4. A Screenshot of the game prototype Two circles and a line where players push two circles over a line to the right while avoiding obstacles. The game world is abstract and minimalist to address the insights from the first prototype.

could potentially be relevant to a physical rehabilitation therapy (if further tests with patients were positive) and made some extra suggestions and remarks for future development. The second session was organized at the end of the design process. The therapists' general impressions were also positive, although they made three suggestions for improvements. These suggestions were taken into account in the further development of the game as described in the next phase.

PHASE 3: ADDRESSING THE PLAYABILITY, THE USER EXPERIENCE, AND SERIOUS ASPECTS

The experimental game prototype of the previous phase contained a number of features that reflected our preliminary game elements (e.g. abstraction and minimalism). However, adding new game elements or fine-tuning present ones in the experimental game would allow us to transform it into a more playable, pleasurable, and useful game. The aim here was not to simply revert it slightly back to the original game concept of *Quake live* (Id Software LLC, 2010), but to reimagine the game in a novel manner in relation to the physical exercises and patient disabilities defined in the first phase (see table 1). Qualitative player tests could then be used to determine the playability and pleasure of the transformed game, and provide incentive to adjust the game further.

Approach

We redesigned the abstract minimalist style according to concepts such as visual feedback (Crawford, 2003) and meaningful choice (Salen and Zimmerman, 2003; Schell, 2008). As such, a novel game prototype called *Collider* was created (see Figure 6) which aims to be usable and interesting to patients. Below are two examples of how this was achieved.

- *Visual feedback:* The graphical style of the previous game resulted from the abstract minimalist process, and therefore did not take into account how potential players will use and experience the game. To address this, changes were made to the current game's graphics. Graphics have to effectively communicate the gameplay (Crawford, 2003; Rouse, 2004), but at the same time should also create an interesting atmosphere to strengthen the play experience. In an attempt to achieve this, consistent changes in colors, gradients, lighting, and details were added to the graphical style, as described below.
- *Meaningful choice:* The horizontal lines in the previous game restricted players in their physical freedom and meaningful choices. As the player-character was completely attached to the line, players could only move forward and backward. To accommodate partial freedom, one half of the player-character has been detached from the guiding line so that the player can move freely about the game world, but still needs to follow the line in order to progress through the game world. In this manner, the player can feel free in the game world, while still being guided by a predefined line.

Result

In the described game, the concept of representing real-life rehabilitation exercises by means of virtual lines is maintained. However, the redesign resulted in four adjusted game mechanics: moving the player-character, pushing the square, passing a triangle, and collecting a point. Furthermore, notable similarities as well as differences can be observed between the described game and the abstract minimalist game introduced. The most noteworthy similarity is that players simultaneously have to guide two objects over a line, and at the same time have to avoid other objects.



Figure 5. The third game prototype, Collider, incorporating the game concept of the second prototype (Two circles and a line), yet with adapted game elements (e.g., graphics and meaningful choice) in order to accommodate playability, user experience and rehabilitation therapy.

Evaluation

Qualitative player tests with patients (n=8) in a participating rehabilitation center had been performed on the game in order to determine how the patients played and experienced the game. In reference to the MDA framework (Hunicke, Leblanc and Zubek, 2004), these tests were divided into three distinct topics, each reflecting a critical component in game design on a functional as well as an experiential level. The first two topics relate to the usability of the game, the first on the level of game mechanics and if patients could properly execute them, and the second on the conceptual level of the game and if players could properly understand the meanings and purposes of the virtual world. Finally, the third topic involves not the game itself, but rather the experience of patients while playing the game. This was done through structured observations based on play heuristics (Desurvire, Caplan, and Toth, 2004) as well as in-game as post-game interviews based on the *game experience questionnaire* (GEQ) (de Kort, Ijsselstein and Poels, 2008). In general, the game was well received by patients to support their rehabilitation process not only in terms of play experience, but also in relation to its style and usability. Several playability and user experience issues were also uncovered, mainly in relation to the controls of the game and how and at what points the players (mis)understood the gameplay.

PHASE 4: THE DEVELOPED CONCEPT MAY BE FURTHER EXTENDED.

The result of the previous phase may already be usable for the specific design assignment. Of course, this does not mean that this result is the final one. In principle, design spaces can always be further explored and novel insights can always be achieved. Therefore, in this fourth and final phase, which may be considered an optional one, designers integrate a new perspective and adapt the design result to that perspective. Having developed the game prototype in the previous phase, novel insights on the design space may have been gained with which to further integrate the game world and the rehabilitation world. In this project, the abstract minimalist elements were adapted to the physical space in which patients perform rehabilitation exercises, resulting in the translation of the style into a new context. This phase may be followed by phase three and four again, and continue until the requirements of the specific project are met.

Approach

Outside of the context of digital games, the attention of stroke survivors and individuals with MS following rehabilitation therapy is directed towards the qualities of the physical world (e.g. manipulating a non-virtual physical object). We therefore started exploring the concept of space in a real-life rehabilitation setting by performing small-scale observations in a rehabilitation center participating in our research project. We did this through observations, which are valuable to gain insights into the context and physical environment in which multiple actors operate during a certain activity (Mulhall, 2003; Lowe and Zemliansky, 2010). Emphasizing the physical world in the context of digital games is markedly different than dividing the attention between the physical world where exercises are performed and the virtual world on a display screen where feedback on these exercises is provided. Simultaneously, in general game design, the concept of game play is often extended outside the virtual world to also include the physical real world (Montola, Stenros and Waern, 2009). We therefore perceived an opportunity to investigate how the prototype can be extended towards the physical world where rehabilitation exercises are actually performed in order to integrate digital feedback in that world. As such, three additional physical game elements were introduced based on an analysis of experimental indie games (e.g., *Bounden* [GameOven, 2014]):

- spatially configure display screen(s) to reflect the physical rehabilitation space in the game's hardware
- use the physical materials as an essential part of the game
- integrate virtual feedback into real objects.

Result

The result is a game called *Shapes* (see figure 6), which consists of a collection of physical interactive objects with simple geometrical forms. The outline of these objects is shaped by polygons or plane surfaces. The overall goal of the game is to combine the individual objects in a wide variety of arrangements. This is done by performing basic physical actions such as lifting, rotating, dragging or pushing these objects in order to bring them together. Whenever a different combination is formed, the color and brightness of the interactive polygons is altered, and whereby new courses of action are suggested. In the current setup, there are three different objects: a cube, a sphere, and a cylinder. All three objects have different shapes and sizes, as well as different sizes of interactive segments. These shapes and sizes affect how patients perform physical actions in order to spatially configure the objects.



Figure 6. The fourth and final game prototype (*Shapes*) in which the style of the third game prototype (*Collider*) were transformed into the physical space.

Evaluation

Preliminary play tests were performed (n=4) in order to determine if patients could physically use the above presented game *Shapes*, and if they would be willing to play it in their own scheduled therapy commissioned by therapists. These tests were divided into three tasks: physically manipulating the objects 1) without any digital feedback, 2) in response to rudimentary digital feedback, and 3) in response to more complex feedback. Structured observations during the tasks were applied to get an indication of how the patients handled the objects, while post-test interviews based on the GEQ (de Kort, Ijsselsteijn and Poels, 2008) were done to get information on how the patients perceived their own handling of the objects. While the objects were well received overall, the patients encountered problems during the tests. For instance, holding the cubical object could be difficult for one patient, while another had more difficulties with getting familiarized with the feedback of the game.

DISCUSSION

At the start of this chapter, we discussed the relevance of creative experimentation in design practice. We argued that experimentation is necessary to bridge gaps of uncertainty which are inherent in design practice. Following this line of reasoning, we investigated the use of uncertainty and experimentation within current serious game design frameworks. We determined that a number of frameworks mitigate uncertainty by providing information on which actions to take in which sequence. In relation to Schön's (1983; 1992) theory of the reflective practitioner we can say that these frameworks suggest how to *move* between two phases of *seeing*. On the other hand, we also established that other frameworks highlight more the *seeing* phase by focusing for example on which game aspects are important in educational and training games. In the former case, a high degree of guidance is available, yet experimentation is rarely or not at all encouraged. It therefore seemed relevant to discuss our own design approach in a completed PhD research project on the creative design of physical rehabilitation (Quinten, 2015) as it situates itself between both cases. We believe our approach offers interesting advantages as well as disadvantages to both cases.

Our design approach was presented in a four-phase framework. In the first phase, preliminary design elements were defined that should guide the formation of a physical rehabilitation game. Two aspects are especially interesting in this phase. First, we acknowledged that in the beginning of a particular project, design researchers might not be aware of all the possibilities and problems further in the design process. For this reason, we refrained from, for example, immediately defining a game concept that would serve as the end product of the project. Instead, we explored game elements that provide a *direction* to what we wish to embody in our end product. In this sense, this phase shares a resemblance with, for instance, Hung and Van Eck's (2010) work who also wish to provide direction by deciding on a game genre before creating an actual game concept. Second, and different to Hung and Van Eck, a working game prototype was created to find these elements. This helped us to practically consider the serious characteristics of our specific project. For instance, by designing the prototype and actually being able to play it, it was much easier to envision the strong connection between game mechanics and rehabilitation exercises which later became critical in our project. A suggestion in hindsight would be to opt for a lower fidelity prototype (e.g., paper prototype) to save time and costs.

The second phase of our framework perhaps diverged the most from other existing frameworks. In this phase, design researchers are explicitly encouraged to momentarily forego the rehabilitation characteristics and context, and instead focus on the game elements identified in the phase one. In order for this to work, these game elements should adequately represent the main serious

characteristics without explicitly referring to them. To give an illustration, if our second game concept applied game mechanics as an integral connection to physical movements in the real world (preliminary game element 1) and had as little genre conventions as possible (preliminary game element 2), we assumed to have a good starting point to include rehabilitation exercises without patients having visual and cognitive problems playing the game. How specific exercises and problems would be addressed, could afterwards be taken into account. We believe one of the most noteworthy advantages of such an experimental approach is that not only the content of the game can be adapted to the serious context, but also the form of the game itself. For instance, without this phase, we would perhaps have developed a more traditional game with an extensive interface. This interface would then have needed to be adapted to the visual and cognitive abilities of future players. However, in our eventual game prototype, we almost completely removed the interface as our experimental game did not need it, thus avoiding this issue altogether.

While we could only shortly address the design approach of the second phase due to limits of space, this phase was perhaps the most creatively complex one. Because there were only two preliminary elements, there were a lot open design possibilities on how to actually design the game. The idea of abstraction and minimization was certainly not immediately clear, nor was it clear that this was a valuable path to take. In spite of this, this phase largely defined the unique look and feel of the final prototypes and in hindsight served as a great way to combine the rehabilitation perspective with the game design perspective. In relation to Schön's (1983; 1992) theory of the reflective practitioner, this phase does not tell how to *move*, but rather encourages design researchers to experiment with this move, as long as they base it on *seeing* the preliminary game elements.

In the third phase, we maintained a more traditional approach to game design. It is interesting to note here again that the project could be considered completed after the third phase. A functional game prototype was developed and showed promise in terms of playability, user experience as well as relevance to the rehabilitation therapy. Nevertheless, a final rehabilitation game—*Shapes*—was developed in which a variety of the previously defined virtual features were merged with a new feature: the physical space. This phase taught us that a design project is never really finished. The design possibilities are theoretically endless and design researchers may always continue to not only refine, but also to expand their products. This provided us with a renewed version of our game prototype that could be used for different purposes within rehabilitation therapy.

Furthermore, the project underscores that different stages of the design process might require different mindsets for evaluating the serious aspect. For example, in the first two phases, our objective was not to find if our particular design would be effective. Instead, these phases served to scope out the design possibilities of how to integrate rehabilitation and game characteristics. Therapists therefore served as experts who commented on the *potential* of the game concept and in contrast to its current usefulness. If we would not have maintained this experimental attitude and directly evaluated with our target audience, these prototypes would perhaps have been discounted on the basis of their lack of playability as well as irrelevance to rehabilitation therapy. Therefore, it is critical to reflect on the underlying potential of the experimental game to advance the further design process, and not only on how it measures to the concept of a fully functioning and effective rehabilitation game. Of course, eventually serious games need to be functional and effective, and these more experimental phases should be followed by a phase with a focus on playability and usefulness.

CONCLUSION

The role of experimentation has been significantly emphasized in the field of design. Yet, this role has not always gone unchallenged in practice. Time and financial constraints can easily sway designers away from experimentation in favor of more immediate results. The importance of frameworks emphasizing experimentation in game design—such as the one presented in this chapter—must therefore not be underestimated. These frameworks encourage designers to embrace untraversed paths that can lead to unexpected yet invaluable results. In our own project, for example, we could not have expected beforehand that the limited visual abilities of our target audience would eventually inspire the abstract minimalist game style which eventually typified the main contributions of our end-result.

The presented experimental serious game design framework tries to reach a fine balance between obtaining concrete results and exploring new design opportunities. Clear learning or training characteristics lay at the root of the framework. However, rather than formulating these characteristics as elements that are simply required to be in the end-product, they are held as starting points of inspiration for the design process. In this manner, the framework transforms these characteristics into design possibilities rather than design difficulties. Designers are thus encouraged to choose where they go, but the predefined learning or training characteristics somewhat limit where they come from. Finally, evaluations with the target audience and educational or training professional make sure designers do not drift too far away from the intended goal. Of course, the role of evaluation is different in each phase. The early phases put more emphasis on evaluating if the experiment was successful, while the third and fourth phases focus more on how the overall goal is addressed.

It is difficult to predict how well our design approach translates to other serious game design projects, especially in an educational rather than a training setting. Nevertheless, it would be interesting to include similar steps of experimentation within existing frameworks to understand how this would affect the overall framework. We hope our example encourages other researchers to add more experimentation in their work and thereby not design unique serious games in spite of educational or training objectives, but rather because of them.

BIBLIOGRAPHY

- Adams, E., 2009. *Fundamentals of game design*. 2nd ed. New Riders.
- Agustin M., Chuang G., Delgado A., Ortega A., Seaver J. and Buchanan J., 2007. Game sketching. In: *Proceedings of the 2nd international conference on Digital interactive media in entertainment and arts (DIMEA '07)*. New York, NY, USA, New York: ACM, pp.36–43. DOI=10.1145/1306813.1306829.
- Bryman, A., 2012. *Social research methods*, 4th ed. Oxford University Press.
- Buxton, B., 2007. *Sketching user experience: Getting the design right and the right design*. Morgan Kaufman Publishers.
- Crawford, C., 2003. *Chris Crawford on game design*. New Riders Publishing.
- Cross, N., 1982. Designerly ways of knowing. *Design Studies*, 3(4), pp.221–227.

- Cross, N., 2006. *Designerly ways of knowing*. London: Springer.
- Darke, J., 1979. The primary generator and the design process. *Design Studies*, 1(1), pp.36–44.
- de Kort, Y.A.W., Ijsselsteijn, W.A. and Poels, K., 2008. The game experience questionnaire: Development of a self-report measure to assess the psychological impact of digital games. In: *Workshop “evaluating user experiences in games”*. Florence, Italy.
- Deen, M. and Schouten, B., 2011. Games that motivate to learn: Design serious games by identified regulations. In P. Felicia, ed. *Handbook of research on improving learning and motivation through educational games: Multi-disciplinary approaches*. IGI Global, pp.330–351.
- Desurvire H., Caplan M., and Toth J., 2004. Using heuristics to evaluate the playability of games. In: *CHI’04 extended abstracts on Human factors in computing systems*. Vienna, Austria. ACM, pp.1509–1512.
- Dormans, J., 2012. The effectiveness and efficiency of model driven game design. In: *International Conference on Entertainment Computing*. Springer, pp.542–548.
- Dorst, K., 2008. Design research: A revolution-waiting-to-happen. *Design Studies*, 29(1), pp.4–11.
- Dorst, K. and Cross, N., 2001. Creativity in the design process: Co-evolution of problem-solution. *Design studies*, 22(5), pp.425–437.
- Eckert, C.M., Stacey, M.K. and Clarkson, P. J., 2003. The spiral of applied research: a methodological view on integrated design research. In: *Proceedings of the 14th International Conference on Engineering Design (ICED’03)* Stockholm, Sweden.
- Edelson, D. C., 2002. Design research: What we learn when we engage in design. *The Journal of the Learning sciences*, 11(1), pp.105–121.
- Fallman, D. and Stolterman, E., 2010. Establishing criteria of rigor and relevance in interaction design research. *Digital Creativity*, 21(4), pp.265–272.
- Forlizzi, J., Zimmerman, J. and Stolterman, E., 2009. From design research to theory: Evidence of a maturing Field. In: *Proceedings of IASDR*, 9, pp. 2889–2898.
- Frayling, C., 1993. Research in art and design. *Royal College of Art research papers*. Available at <http://researchonline.rca.ac.uk/384/3/frayling_research_in_art_and_design_1993.pdf>.
- Fullerton, T., 2008. *Game design workshop: A playcentric approach to creating innovative games*. 2nd ed. CRC Press.
- Game Oven, 2014. *Bounden* [Game].
- Gee, J.P., 2004. *What video games have to teach us about learning and literacy*. Palgrave Macmillan.
- Gericke, K. and Blessing, L., 2011. Comparisons of design methodologies and process models across domains: A literature review. In: *DS 68-1: Proceedings of the 18th International Conference on Engineering Design (ICED11), Impacting Society through Engineering Design*, Vol. 1: Design Processes, Lyngby/Copenhagen, Denmark, 2011.

- Gero, J.S., 1990. Design prototypes: a knowledge representation schema for design. *AI magazine*, 11(4), 26. DOI=10.21918/aimag.v11i4.854.
- Goel, V. and Pirolli, P., 1992. The structure of design problem spaces. *Cognitive Science*, 16(3), pp.395–429.
- Goodman, E., Stolterman, E. and Wakkary, R., 2011. Understanding interaction design practices. In: *Proceedings of the SIGCHI conference on human factors in computing systems*. ACM, pp.1061–1070.
- Guba, E.G. and Lincoln, Y.S., 1994. *Competing paradigms in qualitative research*. In: N.K. Denzin and Y.S. Lincoln, eds. 1994. *Handbook of qualitative research*. SAGE Publications, pp.105–117.
- Gunter, G., Kenny, R.F. and Vick, E.H., 2006. A case for a formal design paradigm for serious games. *The Journal of the International Digital Media and Arts Association*, 3(1), pp.93–105.
- Ho, C.H., 2001. Some phenomena of problem decomposition strategy for design thinking: Differences between novices and experts. *Design Studies*, 22(1), pp.27–45.
- Hunicke, R., Leblanc, M. and Zubek, R., 2004. MDA: A formal approach to game design and game research. In: *Proceedings of the challenges in games AI workshop, nineteenth national conference of artificial intelligence*. AAAI Press, pp.1–5.
- Isbister, K., Flanagan, M. and Hash, C., 2010. Designing games for learning: Insights from conversations with designers. In: *Proceedings of the SIGCHI conference on human factors in computing systems*. Atlanta, Georgia, USA. ACM, pp.2041–2044.
- Jonassen, D., 2010. Research issues in problem solving. In: *Proceedings of the 11th international conference on education research*. Seoul, South Korea.
- Kelle, S., Klemke, R., Gruber, M. and Specht, M., 2011. Standardization of game based learning design. In: *International conference on computational science and its applications*. Springer, pp.518–532.
- Kirkpatrick, G., 2011. *Aesthetic theory and the video game*. 1st ed. Manchester University Press..
- Kruger, C. and Cross, N., 2006. Solution driven versus problem driven design: strategies and outcomes. *Design Studies*, 27(5), pp.527–548.
- Lacay, M. and Casey, J. 2011., Serious games: Fun vs. reality. In: *Proceedings SISO spring SIW 2011*. Boston, Massachusetts, USA: SISO – Simulation Interoperability Standards Organization, pp.38–45.
- Lawson, B., 1990. *How designers think: The design process demystified*. 2nd ed.. Butterworth-Architecture.
- Lawson, B., 2009. *What designers know*. 2nd ed. Amsterdam: Elsevier/Architectural Press.
- Lepe-Salazar, F., 2015. A model to analyze and design educational games with pedagogical foundations. In: *Proceedings of the 12th international conference on advances in computer entertainment technology*. ACM Press, pp.1–14.
- Lim, Y.-K., Stolterman, E. and Tenenberg, J., 2008. The anatomy of prototypes: Prototypes as filters, prototypes as manifestations of design ideas. *ACM Transactions on Computer-Human Interaction*, 15(2), pp.1–27.

- Id Software LLC. 2010. *Quake live* [game].
- Lowe, C. and Zemliansky, P., 2010. *Writing spaces: Readings on writing*. Parlor Press.
- Montola, M., Stenros, J., and Waern, A., 2009. *Pervasive games: Theory and design*. CRC Press.
- Mulhall, A., 2003. In the field: Notes on observation in qualitative research. *Journal of advanced nursing*, 41(3), pp.306–313.
- Norman, D.A. and Verganti, R., 2014. Incremental and radical innovation: Design research vs. technology and meaning change. *Design Issues*, 30(1), pp.78–96.
- Prensky, M., 2001. *Digital game-based learning*. New York: McGraw-Hill
- Quinten, N., 2015 The design of physical rehabilitation games: The physical ambient abstract minimalist game style. PhD. Hasselt University.
- Quinten, N., Malliet, S. and Coninx, K., 2015 Deep content in physical rehabilitation games: On game mechanics and game conventions. In: *Proceedings of the 14th international conference on entertainment computing*. Trondheim, Norway. Springer.
- Roungas, B. and Dalpiaz, F., 2016 A model-driven framework for educational game design. In: *Proceedings of Games and Learning Alliance: 4th international conference*. Rome, Italy. Springer.
- Rouse, R., 2004. *Game design: Theory and practice*. 2nd ed. Jones and Bartlett Learning.
- Salen, K. and Zimmerman, E., 2003. *Rules of play: Game design fundamentals*. The MIT Press.
- Schell, J., 2008. *The art of game design: A book of lenses*. Morgan Kaufmann Publishers Inc.
- Schön, D.A., 1983. *The reflective practitioner: How professionals think in action*. Basic Books.
- Schön, D.A., 1992. Designing as reflective conversation with the materials of a design situation. *Research in Engineering Design*, 3(3), pp.131–147.
- Scrivener, S., 2000. Reflection in and on action and practice in creative production doctoral projects in art and design. *Working Papers in art and design Journal*, 1.
- Smith, M.S., 2012. *Quake live review: Fragging old school*. Available at: <<http://www.alteredgamer.com/quake/49480-live-review-fragging-old-school/http://www.alteredgamer.com/quake/49480-live-review-fragging-old-school/>>.
- Stolterman, E., 2008. The nature of design practice and implications for interaction design research. *International Journal of Design*, 2(1), pp.55–65.
- Unity Technologies, 2016. *Unity3D*. [computer program]. Available at: <<https://unity3d.com/>>.
- Van Eck, R., 2006. Digital game-based learning: It's not just the digital natives who are restless. *EDUCAUSE review*, 41(2), p.16.

Winn, B. 2009. The Design, Play, and Experience Framework. In: P. Felicia, ed. *Handbook of research on effective electronic gaming in education volume 3*. IGI Global, pp.1010–24.

CHAPTER 8

EXPERIMENTAL GAME DESIGN

ANNIKA WAERN & JON BACK

One way to understand games better is to experiment with their design. While experimental game design is part of most game design, this chapter focuses on ways in which it can become a method to perform academic enquiry, eliciting deeper principles for game design.¹

Experimental game design relies on two parts: varying design, and doing some kind of studies related to these variations. In this chapter, we limit the discussion to experiments that involve *people* that play the game.

DESIGN AS AN ACADEMIC PRACTICE

The approaches we discuss in this chapter are best framed within the context of *research through design* (Zimmerman, Forlizzi and Evenson, 2007). This has been articulated as a pragmatic approach to design research, which strives to elicit useful and semi-generic knowledge about design solutions as well as methods. This is an approach that appreciates that all design includes an element of research to inform its design decisions.

Design experiments are part of the design process for most games. Game designers tend to experiment throughout the design process; by adding and deleting components, changing rules, balancing, modifying themes, and changing the way the game interacts with players. They also playtest their designs. Zimmerman (2003) writes exquisitely on how playing a game is part of the iterative design process, and how new questions about the design grows out of each play session, and Fullerton (2008) develops a full-fledged methodology for integrated playtesting and design.

What then, makes design experimentation an academic practice? The short answer is that firstly, to achieve academic validity, experimentation must be done with some level of rigour. Secondly, research through design is done in order to answer questions that are somewhat more generic than just making a singular game better. Experimental design is a research method where the aim is to understand something generic, some more fundamental aspect of game design. Thus, the way we discuss experimental game design in this chapter is a way to, through designing, understand more about design principles for games.

While this chapter focuses on design experiments involving players, playtesting is not completely necessary in experimental design. Many dynamic aspects of game design can be tested without

1. An earlier version of this chapter has been published in Lankoski and Björk (2015).

players. Seasoned game designers often use Excel or similar tools to calculate game balance (Clare, 2013). Joris Dormans (2012) has developed machinations as a useful tool for simulating the dynamics of resource management in games, and game theory presents theoretical tools to understand some of the dynamics of multi-player gaming (Osborne, 1994). It is also possible to experiment with games using simulated players (Bjornsson and Finnsson, 2009).

All of these methods are valuable tools for game design, and have potential to also be valuable in experimental game design research. The problem is that they all rely on abstracting the player. They require that we already know something about how players are expected to behave. But this is seldom true in game design research—rather, we are looking to explore the link between game design and player's behaviour and experience. Hence, while calculations and simulations may help us trim and debug the game we want to experiment with, the research results will emerge from testing the game in practice, with players.

WHEN IS A GAME DESIGN EXPERIMENTAL?

We have already established that the experimental game designs we are looking at, are such that serve to elicit something interesting about design principles for games. Hence, it is not the status of the game design that marks it out as experimental or not. Experimental game designs can be sketchy, consisting of bare-bone game mechanics and interface sketches, or they can be full-fledged games or prototypes that are made publicly available for weeks or months. It is not the format of the game or the trial that determines whether it is experimental but the kind of experiment we plan to perform with the game. We can distinguish between classical, *controlled* experiments that aim to provide answers to descriptive or evaluative questions, and more open forms of experimentation where the aim is to explore and develop innovative solutions. The latter form of experimentation can concern game fragments as well as full games. Below, we distinguish between *evocative* and *explorative* design experiments², which both support more open design investigations.

CONTROLLED DESIGN EXPERIMENTS

The classical approach to empirical experimentation is to use controlled experiments. In a controlled experiment, you contrast multiple setups against each other, to measure the effects of varying a small set of parameters. One performs a controlled experiment where one either subjects different participants to different conditions (inter-subject comparison) or each subject experiences all conditions (within-subject comparison). Knowledge is gained through comparing the results of the two experimental conditions (e.g., Landers and Bauer, 2015). Applied to experimental game design research, this corresponds to varying one or more design factors in a game, and subject players to different versions of the same game.

Controlled experiments have their role in game research in general; and have for example been used in studies that explore how people learn to play games and the gameplay experience. They have also recently got an interesting use in the context of online games. In A/B online testing, two versions of a game are launched in parallel to different parts of the player population and evaluated based on

2. This is not to be confused with critical design (Bardzell and Bardzell, 2013) or critical play (Flanagan, 2009), as critical play is not a research method as much as a play design ideal. And similarly to critical design, it is meant to critically comment on, or react to design. Design experiments on the other hand are neither about artistic ideal, nor about the message of the game. They are rather about the knowledge we gain from studying them.

desirable responses. If one version makes players, say, pay more, then that version may later on be launched as the new standard.

Still, there are many pitfalls in using controlled experiments in the context of design research. The obvious one is that in order to enable experimentation at all, the game must exist and run fairly smoothly. If your aim is to study variants of a computer game and must develop the game to be able to study it, you end up with a very expensive experiment. It is sometimes possible to avoid costs by using game mods to create variations. Other pitfalls include the risk of testing for the wrong thing. If one of two test conditions shows the better results, this of course says nothing about if there might be a third solution that would work even better.

The most challenging factor in controlled design experiments is directly related to experimenting with design. A game is a complex web of design decisions, making it hard to isolate and vary a particular factor without fundamentally changing the game. The only option is often to construct an experiment setup where the game works optimally in one of the conditions, and the other one is a crippled version of the original where a particular design feature has been disabled. The only thing that can be proved by such a comparison is that a particular design feature (the one that is removed) is *not* effective. This problem is aggravated by the fact that it makes little sense to do a controlled experiment, unless the factor that you are varying says something interesting about game design. But if it *is* interesting, chances are that the factor is tightly integrated with the core design choices for the game, and thus impossible to vary without drastically changing the game.

Furthermore, controlled game experiments suffer from the fact that the immediate effect of varying a game design is typically that people start to play the game differently. Salen and Zimmerman (2004) describe this as games being *second order design*. The player experience does not arise from the game as such, but from the game session in which the player has participated. As most games can be played in several ways, a small change in design can have a huge impact on how people play the game. While this is in itself worthy of study, many studies do not take this aspect into account, but only aim to capture the player experience. A confounding factor is that whereas game design certainly has an effect on player engagement, so do a host of other things: including how players were recruited to the study and with whom they are teamed up.

Finally, controlled experiments with design must be repeated several times over in order to yield reliable results at a more generic level than the individual game. Unless experiments are repeated over several games, we know very little about the generalizability of results. In the particular game that you used, it may be true that varying factor A leads to results B. However, will the same be true for another game? Are the results specific to a game genre? Where are the limits—what are the design factors that delimit the validity of the results? No single study can answer these questions.

The example we will use to illustrate this approach is not from game studies, but comes from applied psychology. Choi, et al. (2007) report on a rather well executed design experiment, concerning modes of collaboration in a MMORPG. The goal of this study was to investigate how reward sharing interacts with how dependent you are on grouping up to achieve a task. The authors tested for experiences of flow, satisfaction, and sense of competence. Essentially, the result was that if players could achieve a goal independently of each other (despite the fact that they played in a group), they had more fun, experienced more flow and felt more competent if they also received rewards independently of each other. And conversely, if the players were dependent on each other they had more fun, experienced more flow, and felt more competent if they also shared the rewards.

This experiment avoids several of the potential pitfalls. First of all, the experiment was done with a pre-existing game, rather than a game prototype developed for the purpose of the study, short-cutting the issue of having to develop a full game. The game was modified (cf. Mohseni, Liebold and Pietschmann, 2015) to generate the experiment conditions, and multiple versions of the game were installed at local servers. Secondly, the goal of the study was *not* to study the game with or without a given design feature. Instead, the study explored how two varied factors interacted with each other (solo or group goal achievement, solo or group reward), avoiding the comparison of an optimal setup with a suboptimal one. Finally, the factors that were varied were at the game mechanics level and as such represented core design factors, while still sufficiently isolated so that they could be varied without rewriting large parts of the code.

Despite this, the study still fails to convince. The main problem is that in the setup where players could achieve the goal on their own without help of each other, the game also became significantly *easier*. Hence, it is possible that players changed their play style under this condition. Maybe they dispersed to do different challenges in parallel; maybe they just sat back and took turns in defeating the enemies. The article does not present any description of the gameplay strategies that developed under the different experiment conditions.

From a game design perspective, the topic of the article can also be challenged. The argument made is that interdependency is an important concept in MMORPG design. While this may be true, the results of the study come across as trivial: if a game challenge is designed to be played by several players together, it had better matter that you are not playing on your own. Most likely, any MMORPG player or game designer would dismiss such a result as self-evident. It is significant that the article has been published in applied psychology rather than as a game research article; it says something about social psychology applied to games, but little about game design.

Finally, the article uses a rhetorical trick to inflate the generalizability of the study—it never mentions which game is studied! The game is discussed only as “a MMORPG”. This tacitly implies that the results would hold for any game in the genre, an over-generalization that any game design researcher should be wary about.

EVOCATIVE DESIGN EXPERIMENTS

Most of the informative design experiments in game design research are much less rigid than the controlled experiments discussed above. Essentially, they fulfill a similar role as iterative play testing does in the practice of game design; they are done to iteratively refine an innovation. The difference is that in design research, the design experiments are not about refining a particular game—they are done to elicit more abstract qualities about games.

The distinction is important, because experimental design research can have completely different objectives than looking for optimal design solutions. The games need not be meant to be good games, and the experiments may focus on other factors than player satisfaction. The overarching goal for this type of design experimentation is to explore the design space of game design, by understanding more about the behaviour and experiences that a design choice will evoke in players. Hence, we can call this class of design experiments *evocative*.

Evocative design experiments tend to be rather open. Even if designers typically already have an idea of how a particular design choice will affect player behaviour and experience, the unexpected effects tend to be even more important. Schön (1983) describes how most design practices include design

sketching, such as the drawings used in architecture. When the design manifest in material form it talks back to the designer, highlighting qualities of the idea that were previously unarticulated or even unintended. In this way new designs find solution, but also reveal new problems. This shows how the iterative design process is not always as straightforward as it is made out to be, but by necessity it is a rather messy process going back and forth between several different tasks of creating, observing and understanding the design (Holopainen, Nummenmaa and Kuittinen, 2010). Since game design is second order design, games do not manifest in sketches, but rather by being played. It may or may not matter who plays the game. Zimmerman (2003) describes a game design process where the early game play sessions were carried out within the designer group. The argument for designers playing the game is that it provides them with the full subjective experience of being a player. The argument against this approach is that internal playtesting very easily turns into designers designing for themselves, rather than for an intended audience. Both designer play and early user group playtesting have a function in game design research, and the choice depends on the design qualities you are exploring. Design experimentation is typically first done within the designer group, but if the core research questions are intrinsically related to the target group, it might be better to involve players from the target group from start.

It is often possible to do evocative game design experiments with very early game prototypes, and there are a multitude of ways to do so (Eladhari and Ollila, 2012). The game mechanics for computer games can for example be tested early by implementing them in a board game (Fullerton, 2008) or by simulating them in *Wizard of Oz setups* (Márquez Segura, et al., 2013). An interesting option is *body-storming* (Márquez Segura, et al., 2013), which can be used when you wish to study the social or physical interaction between players in a computer or otherwise technology-dependent game. In body-storming, players are given mock-up technology that they *pretend* is working. This means that the rules of the game are not enforced by the technology, but through the social agreement between players. An interesting aspect of body-storming a game is that its rules need not even be complete, as players may very well develop their own rules while pretending to play the game.

While evocative design experiments are considerably simpler to perform than controlled design experiments, they still present some pitfalls. First of all, the games need to be rather simple. To enable experiments that elicit something about the design factor tested, the game needs to be stripped of as much as possible apart from this factor. This requirement may be difficult to reconcile with the fact that the game also must be playable, and that the game must have a way to manifest. Game structures cannot be tested without some kind of surface structure—there must be something that players can interact with.

In a recent project (Back and Waern, 2013; 2014) a range of evocative game design experiments were performed, and two in particular serve well to illustrate the opportunities and pitfalls of evocative game design experiments. The game under development, *Codename heroes*, was a pervasive game (cf. Montola, Stenros and Waern, 2009). It was played on mobile phones in public place as well as with hidden physical artefacts. The core game mechanics centred on virtual messages that players moved between the artefacts by walking from place to place. The game was developed as a research prototype. The research goals for this project were two-fold: one was to develop game mechanics and thematic aesthetics that can be engaging for young women and encourage them to move more freely in public space (Back and Waern, 2013). The second goal was to develop pervasive game mechanics that can scale to large number of players over large areas (Back and Waern, 2014), while the game still manifests physically rather than being confined to the mobile phone display. In order to

understand better how the different aspects of the game worked to fulfil our design goals, the game was deconstructed and tested in parts, in the form of meaningful mini-games.

Game test 1: Pen-and-paper prototyping

An early game test with *Codename heroes* focused on developing an understanding of the types of gameplay that would emerge from the core game mechanic, the message passing system. This playtest focused on the experience of moving physically to transport virtual messages delivering them to other players and to specific locations.

This design experiment was done very early during the design process, and while the end result would be a game on mobile phones, no implementation was running at the time of the test. Hence, we had to somehow simulate the core game mechanics, that of physically carrying—and potentially also *losing* messages. In order to make message passing an interesting challenge, messages can be lost in *Codename heroes*. If a message is carried too far or for too long time, a team may lose it and other teams may pick it up. We needed to simulate this function in the playtest. It was simulated using coloured envelopes: every team had a colour, and could only carry messages in envelopes of their own colour. A location tracking system from a previous development project was repurposed to enable tracking the participants. If a team would travel too far in one direction the game masters would send them a text message, telling them to change the envelope of a message and leave it at their current location.



Figure 1. Players searching for an artefact during a game test. The image is from a later test than the one mentioned in the text.

It is important to emphasise that while this function was simulated, other parts of the game design were not. In particular, the play experiment was done with actual movement (as seen in figure 1)—we did not test the game mechanics in the form of a board game, which could have been done easily. Since a core design goal of *Codename heroes* is to encourage and empower young women to move in public space, we specifically did not want to take away this aspect. Players walked—and ran—considerable distances in this play test, and part of the game was located in an area that we thought could make players feel uncomfortable. It was also important to recruit players from the target audience to this test—most of the players were young women.

Several things were learned from this game test. Firstly, the experiment supported the assumption that the spy-style message passing game mechanics was attractive to the participating young women representing our core target group. We also found that the game indeed had the potential to encourage the participating women to move about in public space. We could observe that by teaming up and making the movement part of a game, the participants selected to move about in areas they otherwise would have avoided, and also that this was a positive and empowering experience (Back and Waern, 2013).

The design experiment also talked back to us in a slightly unexpected way. Despite the quite clumsy way that players had to simulate some of the game functionality, the physicality of messages and envelopes added greatly to the game experience. For example, on one occasion a group of players came across a message that another group had been forced to leave. When spotting the envelope from afar they shouted out in joy, and reported this as one of the highlights in the playtest.

This playtest also exhibited an element of body-storming in that not all of the game rules were given. In particular, we did not tell the groups whether they would be competing or collaborating. The rule mechanic of leaving and picking up messages from each other could be interpreted either way. At the end of the game, the three groups came together to solve a riddle, but we had also used a scoring system to calculate scores for the individual teams. Players were not informed about this before starting to play. The reason was that we wanted to test how the participating young women would interpret the situation. Would they collaborate, or compete? In the end, we saw elements of both. The groups did a bit of collaboration on finding messages, in particular towards the end, but mostly played separately. When asked about it after the game had finished, they decided that they had been doing both. One of the participants articulated this as “we won together, but *they*” (the group that had got the highest score) “get to sit at the high end of the table”.

This is a good example of an evocative game experiment. It used a stripped-down game design with a partial implementation, letting players simulate some of the functions that later were to be implemented. Furthermore, while one of the reasons for doing the experiment was to test if the core game mechanics (carrying messages around) was sufficiently engaging, we left parts of the game underspecified and looked for how the participants would interpret the situation. We studied the activities and experiences that the game evoked, and, some of the core insights came from unexpected aspects of the experiment design, such as the high value of the physical aspects of message passing.

Game test 2: Testing the artefacts

In subsequent design experiments, we focussed specifically on the physical aspects of the game. While the message-passing system is virtual and supported by a mobile phone app in *Codename heroes*, the game includes physical artefacts that can affect its function.

In order for the game to scale to arbitrary space and arbitrary numbers of users, the number of artefacts must also scale. This is why the game primarily relies on players constructing the artefacts. The construction, activation, and physical distribution of artefacts constitute the second core game mechanic in *Codename heroes*, and more generally is an interesting game mechanic. While the example of *Geocaching* (studied, e.g., by Neustaedter, et al., 2013) shows that it is fun to both hide and find artefacts in a treasure hunt style game, *Codename heroes* is not a treasure hunt game. Hence, it was not certain that the experience would be the same. Furthermore, it was important to understand under which conditions the activity of constructing a game artefact would be an attractive game activity in itself.

Again, we constructed a mini-game, this time with focus on artefact construction and distribution. We let players build artefacts in a workshop, and use them to search for and distribute messages (see figure 2). However, we left out the challenges related to messages: players could not lose messages and there was no challenge related to finding a particular set of messages.



Figure 2. Artefacts being built during the construction game test.

While the activity of building artefacts in a workshop was engaging and rewarding, the rest of the experiment suffered from a lack of game mechanics. In particular, it was unclear to players if there was any progression towards some kind of goal. The effect was that we ran into difficulties both with recruiting participants to the experiment, and with players not completing the game.

The setup illustrates a risk with the mini-game approach, in that not every game mechanic can run in isolation. In our effort to at the same time avoid testing the message passing over again and not creating a hide and seek game, we had unintentionally created an interactive experiment that was not a game at all.

EXPLORING A GAME GENRE

An ambitious objective for experimental game design is to explore a novel game genre. Although this still allows for small and focussed experiments, the ambitious goal will often require the development and staging of full-scale and sufficiently complex games, that are extensively studied. An example of an ambitious project that aimed to explore design for an entire game genre was the European project *IPerG: The integrated project on pervasive gaming*. The project included several large-scale experiments with a fairly novel and under-researched genre, that of pervasive games (cf. Montola, Stenros and Waern, 2009).

Needless to say, this form of design experimentation is time- and resource-consuming. There is very little difference in effort between developing a full-scale game in order to research it, and launching it as a commercial or artistic product. A large-scale game experiment will typically go through the same design process, with multiple design iterations and playtesting, an alpha and a beta phase, and so on. While the process may end after beta testing rather than include a commercial launch (as that falls outside the scope of research), the final experiments can be large-scale and come across as open beta testing to the players (McMillan, et al., 2010).

The differences again lie in how the game is designed, and in how the testing is done. An experimental game needs to emphasise the factors that are interesting from a design research perspective. For example, the pervasive game *Momentum* was extreme in its attempt to merge role-play with everyday life (Stenros, et al., 2007; Waern, et al., 2009). This research was ethically challenging, as it meant that role-players would meet and interact with people who were not themselves playing and that might not even be aware of the game. A major result from this research was a deepened understanding of the ethical challenges of pervasive games in general (Montola and Waern, 2006a; 2006b).

The emphasis on trialling specific design factors can come in conflict with the designers' desire to also make an interesting and attractive game. This is less of a problem in evocative design experiments as these are smaller and also often done early, as part of the design process for a larger game. In full-scale design experiments, this can lead to conflicts within the research group as well as cumbersome compromises in design. Montola (2011) discusses this in particular in relationship to technology-focussed research questions. If one of the purposes of the project is to develop and test new technology, this can very easily come in conflict with the designers' wish to make a good game, if the technology is buggy, slow or not ready on time.

Studying large game experiments presents its own challenges (Stenros, Waern and Montola, 2011), in particular with understanding something about the relationship between specific design choices and the play behaviour and experiences that players exhibit. This is the reason why a typical game experiment will look rather different from an ordinary beta test. The game experiment requires extensive documentation, both in terms of filming, recording and logging play behaviour, and player's active reporting of their game play activities and experiences. It may be necessary to emphasise quality over quantity (Stenros, Waern and Montola, 2011). The rich data is necessary in order to be able to deconstruct the play behaviour to identify instances of play that reflect particular game design elements. These can then be scrutinized in detail, to understand something about their effects on player behaviour and experience.

The study of experimental games is thus a complex and expensive interpretative process, which can be very rewarding if the game is innovative or focussed on interesting design qualities. In total, the process of experimentally developing a design understanding of a game genre is very expensive, in

design and development as well as in testing, and can only be recommended when genre in question is novel, important, and under-researched.

BEST PRACTICES AND CONSIDERATIONS

There are many similarities between experimental game design research, and the practice of game design. In particular, game design research will often use explorative and interpretative experiments rather than classical controlled scientific experiments. However, there are also some important differences. In particular, there is a difference in the goals—experimental game design should primarily aim to explore design factors that are novel or may be problematic, rather than to actually generate playable games. It should also aim to present these answers in a more generic way than just as applicable to a single game. To answer research questions is the main objective, and must supersede making a good game. This difference underlies the best practice recommendations summarized below.

In order for a *controlled experiment* to be relevant in game design research, it must be possible to vary the game in a way that does not cripple it. There is little reason to test two versions of a game, if one is simply lacking an important element for the game to work. Furthermore, the design factor that is varied must be sufficiently interesting in a wider context than just that single game. As argued by Zimmerman, Forlizzi and Evenson (2007), design research is judged primarily by its relevance to design.

Trialling a specific game design factor can also be done in *open and evocative design experiments*. These can even be done with incompletely designed or implemented games; by limiting the test to a smaller part of the game, or by manually simulating parts of the game. But evocative design experiments must still be properly documented, and open for the fact that they can yield unexpected results as the design reveals not only answers but also new problems. Further, it does not work to trial just any random idea – the game must be understandable and be playable by the participants.

Even *large-scale and fully developed games* can be developed for the purpose of explorative design research if needed, for example, if the goal is to trial innovative game design solutions in underexplored game genres. These experiments face particular challenges in data gathering and hypothesis testing, as it becomes difficult to attribute player behaviour to particular design factors. Where possible, it is therefore preferable to use smaller games or limited parts of games, not only because of the above-mentioned reasons, but also due to costs. This is discussed in more depth in Stenros, Waern and Montola (2011).

CONCLUDING REMARKS

While this chapter has focussed on experimental game design as a scientific paradigm, many of the practices are similar to those of user-centred game design as a practice. Tracy Fullerton's (2008) book *The game design workshop* is hence an excellent resource for developing a good overall process also in experimental game design.

There exists very little meta-level discussion of the kinds of knowledge that is the result of design research on games. However, there has been an intense discussion in the field of interaction design research that is also relevant for design research on games. Zimmerman, Forlizzi and Evenson (2007) argue that the designs produced within design science are contributions by themselves. Adopting a more theory-focussed perspective, Höök and Löwgren (2012) instead argue that design research

should aim to produce ‘strong concepts’, as loose description of design theories that are at the same time scientifically defensible and relevant in the design process. Based on Salen and Zimmerman’s (2004) observation that game design can be described as second order design, we believe that for games, useful design concepts are often activity-centric, focussing on the play activities that a particular game is trying to foster (Waern and Back, 2017).

Finally, proper data gathering is central to maintaining scientific rigor also in design science, but data gathering can be tricky in particular in large design experiments. Stenros, Waern and Montola (2011) present an overview of data gathering methods for pervasive games. While the article focuses on games that are played over large physical areas, most of the issues presented in the article apply to a wide range of games.

BIBLIOGRAPHY

- Back, J. and Waern, A., 2014. Codename heroes: Designing for experience in public places in a long term pervasive game. In: *Foundations of digital games (FDG)*. Fort Lauderdale. April.
- Bjornsson, Y., and Finnsson, H., 2009. Cadiaplayer: A simulation-based general game player. *IEEE Transactions on Computational Intelligence and AI in Games*, 1(1), pp.4–15.
- Choi, B., Lee, I., Choi, D. and Kim, J., 2007. Collaborate and share: An experimental study of the effects of task and reward interdependencies in online games. *CyberPsychology & Behavior*, 10(4), pp.591–595.
- Clare, A., 2013. Using Excel and Google Docs for game design. *Reality is a Game* [blog]. 4 April. Available at: <<http://www.realityisagame.com/archives/1819/using-excel-and-google-docs-for-game-design/>>.
- Collins, A., Joseph, D. and Bielaczyc, K., 2004. Design research: Theoretical and methodological issues. *Journal of the learning sciences*, 13(1), pp.15–42.
- Cross, N., 2001. Designerly ways of knowing: design discipline versus design science. *Design issues*, 17(3), pp. 49–55.
- Dormans, J., 2012. *Engineering emergence: Applied theory for game design*. PhD. University of Amsterdam.
- Eladhari, M., and Ollila, E., 2012. Design for research results: experimental prototyping and play testing. *Simulation & Gaming*, 43(3), pp.391–412.
- Fullerton, T., 2008. *The game design workshop: A playcentric approach to creating innovative games*. Boca Raton: CRC press.
- Holopainen, J., Nummenmaa, T. and Kuittinen, J., 2010. Modelling experimental game design. In: *Proceedings of DiGRA Nordic 2010: Experiencing games: Games, play, and players*. DiGRA.
- Höök, K. and Löwgren, J., 2012. Strong concepts: Intermediate-level knowledge in interaction design research. *TOCHI*, 19(3), pp.23:1–23:18. DOI=10.1145/2362364.2362371.
- Kelly, A. E., 2003. Research as design. *Educational researcher*, 32(1), pp. 3–4.

- Landers, R. and Bauer, K., 2015. Quantitative methods and analyses for the study of players and their behaviour. In: Lankoski, P. and Björk, S., eds., *Game research methods: An overview*. ETC Press, pp. 152–173.
- Lankoski, P. and Björk, S., eds., 2015. *Game research methods: An overview*. ETC Press.
- Lim, Y., Stolterman, E., Jung, H. and Donaldson, J., 2007. Interaction gestalt and the design of aesthetic interactions. In: I. Koskinen and T. Keinonen, eds., DPPI, *Proceedings of the 2007 conference on designing pleasurable products and interfaces*. Helsinki. August. ACM, pp.239–254.
- Márquez Segura, E., Waern, A., Moen, J., and Johansson, C., 2013. The design space of body games: technological, physical, and social design. In: ACM, *Proceedings of the 2013 ACM annual conference on Human factors in computing systems* New York: ACM, pp.3365–3374.
- McMillan, D., Morrison, A., Brown, O., Hall, M. and Chalmers, M., 2010. Further into the wild: Running worldwide trials of mobile systems. *Pervasive Computing*. Helsinki, May. Springer Berlin Heidelberg, pp.210–227.
- Montola, M., Stenros, J. and Waern, A., 2009. *Pervasive games: Theory and design*. Morgan Kaufmann.
- Montola, M., 2011. A ludological view on the pervasive mixed-reality game research paradigm. *Personal and Ubiquitous Computing*, 15(1), pp.3–12.
- Montola, M. and Waern, A., 2006a. Ethical and practical look at unaware game participation. In: S. Manthos, ed. 2006. *Gaming realities. A challenge for digital culture*. Athens: Fornos Centre for the Digital Culture, pp.185–193.
- Montola, M. and Waern, A., 2006b. Participant roles in socially expanded games. In: *PerGames workshop of pervasive 2006 conference proceedings*. Dublin . May. Dublin: University College Dublin, pp.165–173.
- Mohseni, M.R., Liebold, B. and Pietschmann, D., 2015. Extensive modding for experimental game research. In: P. Lankoski and S. Björk, eds. *Game research methods: An overview*. ETC Press, pp. 323–340.
- Neustaedter, C., Tang, A. and Judge, T.K., 2013. Creating scalable location-based games: Lessons from Geocaching. *Personal and Ubiquitous Computing*, 17(2), pp.335–349.
- Osborne, M.J. and Rubinstein, A., 1994. *A course in game theory*. MIT press.
- Salen, K. and Zimmerman, E., 2004. *Rules of play: Game design fundamentals*. MIT press.
- Schön, D.A., 1983. *The reflective practitioner: How professionals think in action*. Basic Books.
- Simon, H.A., 1981. *The sciences of the artificial*. Cambridge: MIT Press.
- Stenros, J., Montola, M., Waern, A. and Jonsson, S., 2007. Play it for real: Sustained seamless life/game merger in Momentum. In: B. Akira, ed., 2007. *Situated play*. Tokyo: September. DiGRA, pp.121–129.
- Stenros, J., Waern, A. and Montola, M., 2011. Studying the elusive experience in pervasive games. *Simulation & Gaming*, 43(3), online first. DOI=10.1177/1046878111422532.

Waern, A., Montola, M. and Stenros, J., 2009. The three-sixty illusion: Designing for immersion in pervasive games. In: *Proceedings of the SIGCHI conference on human factors in computing systems, CHI'09*. ACM, pp.1549–1558.

Waern, A. and Back, J. 2017. Activity as the Ultimate Particular of Interaction Design. In: *Proceedings of the 2017 CHI Conference on Human Factors in Computing Systems, CHI '17*. ACM, pp. 3390–3402.

Zimmerman, E., 2003. Play as research: the iterative design process. In: B. Laurel, ed. 2003. *Design research: Methods and perspectives*. MIT press.

Zimmerman, J., Forlizzi, J. and Evenson, S., 2007. Research through design as a method for interaction design research. In: *Proceedings of the SIGCHI conference on human factors in computing systems, CHI '07*. ACM, pp.493–502.

CHAPTER 9

GOING INDIE

METHODS FOR UNDERSTANDING INDIE PRODUCTION

ALYEA SANDOVAR

Without culture, and the relative freedom it implies, society, even when perfect, is but a jungle. This is why any authentic creation is a gift to the future. (Camus, 1942)

One of the best known digital games of the 20th century, published in 1980 in Japan and the U.S., was *Pac-Man* (Namco, 1980). To contrast the shooting games of the time (for example, *Space Invaders*, Taito, 1978), Toru Iwatani designed a game, originally known as *Puck-Man* (Champagne, 2013) which incorporated mazes and ghost characters to make the game appealing to young girls. The name changed to *Pac-Man* when the game entered the U.S. market because *Puck-Man* could easily be misunderstood.

As Iwatani intended, *Pac-Man* changed the arcade culture forever by making the game accessible to many audiences. The abstract nature of *Pac-Man* not only influenced audiences but also changed the way games were designed (Champagne, 2013). Game designers began to experiment with colors, mechanics and storylines. As a result, *Pac-Man* not only became an icon of 1980's popular U.S. culture but also an important part of game history (Melissinos and O'Rourke, 2012). In 2012, *Pac-Man* became part of the Smithsonian's *Art of video games*, the first exhibition of the 40-year history of digital games.

Today digital games and those who make them continue to inform audiences, design, and world culture. Despite the impact of digital games, research on game designers and their design process is limited. A large majority of literature in game studies focuses on understanding games and designs from the humanistic perspective, not the designer perspective. Game production literature provides some reasons for this limitation and highlights the difficulties of entering game studios to conduct research (O'Donnell, 2014). However, game studios are not the only segment of the industry which can provide information on games and their creators. There is also a growing body work on game development through game jams (Kultima, 2015) as well as literature on indie game production (Guevara-Villalobos, 2011) that legitimizes the need to study independent game production. This chapter shortly comments on why researching game designers is key to understanding digital games, reviews the importance of the growing indie scene (including research) and proposes the use of visual methods for interrogating game designers about their work.

THIS INDIE THING: A BRIEF HISTORY

While the independent games festival was established in 1997 as part of the Game Developer's Conference, it was not until the summer of 2000, that the game developer community expressed the importance for independent game work. That year, the Scratchware Manifesto was written by a group

of game developers who saw the need to break away from the money churning machine the games industry had become:

The machinery of gaming has run amok.

Instead of serving creative vision, it suppresses it. Instead of encouraging innovation, it represses it. Instead of taking its cue from our most imaginative minds, it takes its cue from the latest month's PC Data list. Instead of rewarding those who succeed, it penalizes them with development budgets so high and royalties so low that there can be no reward for creators. Instead of ascribing credit to those who deserve it, it seeks to associate success with the corporate machine.

It is time for revolution. (Designer X.)

The statement was a call to the game industry to return to its roots of independence, flexibility and creativity. Its aim was to critique current publishing practices, highlight the biased preferences of publishers for certain games and game designers, and to shed light on the unethical work practices in game development.

Eric Zimmerman (2002) playfully pondered "Do independent games exist?" in *Game on: The history and culture of videogames*. In this short chapter he answers that indies both exist and do not exist. He divides the game industry into three areas: *economic*, *technological* and *cultural*. Economic refers to the marketing and distribution of the game, technological refers to the scope of production and cultural addresses the geek culture present in games. To answer the question of whether independent games exist or do not exist, he created two columns for each of the sections (economic, technological and cultural) and invites those unfamiliar with games to read the left column and the game developers to read the right column. In this way, he invites the game community to make independent games possible, to get angry and change the state of gaming.

In 2005, *Indiecade* was established by Stephanie Barish and Creative Media Interactive as part of E3. Game designers as well as game researchers came together to create a space for interactive media. Advisors included well-known game designers such as Robin Hunicke, Tracy Fullerton, and Eric Zimmerman as well as notable academics including Celia Pearce and Frans Mäyrä. However, it was not until 2007 that the festival spun off and became the first and only independent games festival in the United States. During the period of 2006 and 2009 other events supported the development of independent games. In 2006, *Nordic game jam* was created by a Danish developer Gorm Lai, academic Jesper Juul, and interaction designer Henriette Moos. The purpose of the game jam was to bring game developers to design and develop experimental games over 24–72 hours. A few years later, in 2008, with the support of the IGDA, Gorm Lai and Susan Gold founded *Global game jam*. The first global game jam happened in 2009. Global game jam is a yearly global event where aspiring game developers, industry experts and students could come together at designated locations throughout the world to build games for 72 hours. The theme of the first GGJ was "As long as we have each other, we will never run out of problems" and with 1600 participants in 23 locations worldwide. Game jams not only supported experimentation, but also served to develop, grow and launch indie games and studios. Thus by 2013, the Game Developers Conference yearly poll showed that 53% of all game developers identified with the term Indie (Gamasutra, 2013). Today, the growth of mobile platforms, open source tools, crowdfunding, and access to new forms of digital distribution have made success a possibility rather than a dream.

<p>The technology is getting better. There’s no other cultural medium like games that reinvents its own technical capabilities every few years. New game technologies mean more depth, more complexity, and more ways to play. Technology drives innovation.</p>	<p>Technology is overemphasized. The game industry is completely technofetisistic, with the value of games typically judged on their technical merits. Innovation in games needs to come from sources other than hardware and software technology.</p>
<p>Games are bigger than ever. No longer the product of a single programmer, games are substantial undertakings requiring the kind of creative, multi-stage, interdisciplinary collaboration found in film. The increase of professional standards in regard to scope and process is a necessary step in the maturation of the medium.</p>	<p>Games are bigger than ever. As games get bigger, they get more expensive. And the most expensive games set the standard for production values in all games. Games are complicated to produce and low-fi approaches are frowned upon. It’s possible for a band to record an album in a garage over a weekend. But not so with games.</p>
<p>New game platforms keep the industry on its toes. The constant competition between the major industry players means that games will always be maximizing the latest capabilities of PCs and that new consoles will appear on the market every year or two. Games must rise to meet these ever-changing technological needs and the result is a lack of stagnation in the games themselves.</p>	<p>The industry indulges in planned obsolescence. Platform follows platform like the Emperor’s new clothes. The resulting plethora of standards makes archiving and playing older games a hobbyist’s trade, rather than the more universal formats of the videotape or audio CD. The result is a medium without a history, in which tech innovation becomes an end, not a means.</p>
<p>Games are merging with cinema. Technological advances, particularly in real-time graphics, means that games are becoming more “realistic” and increasingly resemble film. The cinematic turn in games will allow developers a broader palette of expressive tools that will appeal to new kinds of game audiences. Games will absorb and replace film.</p>	<p>Games suffer from cinema envy. What passes for “realism” in games is an awkward and unimaginative use of 3D computer graphics. It’s time for game developers to stop trying to replicate the pleasures of film. Games need to find their own forms of expression, capitalizing on their unique properties as dynamic, participatory systems.</p>

Table 1. Geek science: Technological factors. (From Do independent games exist? Zimmerman (2002). Copyright 2010 by Eric Zimmerman.

INDIE GAMES RESEARCH

So what of independent games in game studies? In his summary of the independent games literature Parker (2013) titles his paper *Indie games studies year eleven*, and uses Zimmerman’s (2002) thoughts on independent games as the starting point for indie game studies. Martin and Deuze (2009) also allude to independent games scene thriving around 2003 and refer to Michael’s (2003) book *The indie game development survival guide*. However, indie games studies do not appear to have gained momentum in academia until 2007.

In the academic Western literature discussion on independent games began by first defining independent games and mapping the independent game development scene. One of the earlier mentions of indie games appears in Jahn-Sudmann (2008) where he refers to the utilization of film practice (from the United States) as a role model in defining independent games and to claim that these are not in opposition to the mainstream publishing game streams but rather a form of innovation. Shortly after, a cultural production perspective was published by Martin and Deuze (2009) in which they discussed how the structure of the games industry informs concepts of independence and the culture of independent production. Their review included an evaluation of

<p>Game developers care about their work. With lower average salaries than the rest of the software development industry, game developers make games because they love what they do. The game development community is fiercely dedicated to the craft of making games and almost universally disgruntled with the homogeneous nature of the game industry. With these attitudes, breakout independent games are inevitable.</p>	<p>Games are made by and for hardcore gamers. Until this cycle is broken, culturally games will remain stuck right where they are. Game developers are unapologetically geeky, blatantly anti-intellectual, and hostile to new ways of thinking about what they do. There are no established critical methodologies for game design and without ways of thinking outside the box, independent games are doomed.</p>
<p>Games are diversifying. Games are no longer the domain of young males. For example, the girls' games movement made great strides in opening up new audiences for games. The internet has introduced gaming to an older, multicultural audience of both genders. An increasingly "interactive" society will demand interactive entertainment and as the cultural credibility of games improves, they will replace other media to become wired society's dominant leisure activity.</p>	<p>The more things change, the more they stay the same. The legacy of the girls' game movement isn't experimental, independent games: it is Barbie CD-ROMs. Games, like comic books in the US, will never shed their stigma as power fantasies for adolescent boys. Despite the incrementally diversifying audience for gaming, it's naïve to think that games will ever usurp film and television as dominant forms of entertainment.</p>
<p>Games are influential pop culture. Fine artists are appropriating the imagery of computer games. DJs are sampling retro game audio effects. Videogame characters' feature on Urban Outfitter t-shirts. Playstations have been a mainstay of London clubs for years. This kind of hybrid appropriation is how healthy and robust media operate and is the proof of the relevance of games in culture at large. Game soundtracks feature tracks from hot DJs. Independent games will emerge from the intersection of games with music, fashion, and other forms of culture.</p>	<p>It's a one-way street. It's true that games are being appropriated by other forms of culture. But the reverse just isn't true. The aesthetics and narratives of games are almost completely genre-bound. Game design and development needs to be a cultural activity. This means, among other things, the development of a critical discourse that can bridge the theory and practice of games and help developers understand their work as both as a disciplinary activity and in broader terms as the production of culture. Games should appropriate from a broader array of cultural sources. Forget D&D: how about Cubism or Hitchcock?</p>
<p>Game subcultures are thriving. From user-created game levels and avatars to grassroots online game fan communities to the cultures of hacks and mods, the subcultures of games are incredibly rich. So, stop complaining: independent games are already here.</p>	<p>There's a difference between fan culture and independent games. Game subcultures are composed of hardcore gamers and are focused inward, on their own communities, rather than being concerned with changing the face of gaming culture at large. A true independent games movement will be something entirely different.</p>

Table 2. The little boy's club: Cultural factors. (From Do independent games exist? Zimmerman (2002). Copyright 2010 by Eric Zimmerman.)

the independent games industry at many levels such as industry structure, technology laws and regulations, organizational structures, careers, and markets.

Around this time, Kemppainen (2009) also provided a structure for the study of independent game production. He proposed that these could be studied through the production itself, the product or the producer. Like, Jahn-Sudmann (2008), Kemppainen attempted to define and compare independent

game production to the film industry. Through his paper, he proposes that Indie game production is defined by a signature:

1. independent style and content
2. a spirit of independence and freedom
3. dependencies to the monetization models.

He also argues that defining indie as all three is not necessarily accurate. He provides the example of casual games, that are independent in production, defined by the need to monetize but do not carry the spirit of being indie.

By 2011, a shift occurred to not only define what indie was but rather to explore and review the different types or explorations of independent game production. In 2011, several papers on independent games were also presented at Digital Games Research Association (DiGRA) conference, for example, the paper by Guevara-Villalobos (2011) examining the relationship between community and labor of independent games as well as independent game work. Guevara-Villalobos reports on findings from interviews with independent game workers. His work will be further explored in the next section as his results highlight a type of game production that is accessible to game researchers.

In 2013, independent game development studies appeared to gain momentum through a special issue of *Loading...*, a journal from the Canadian Game Studies Organization, that focused on independent games. The special issue presented several perspectives on independent game studies including gender politics (Fisher and Harvey, 2013), politics and narrative of production (Lipkin, 2013; Ruffino, 2013), comparing indies to craft work (Wescott, 2013) aesthetics of independent games (Parker, 2013), innovation of indies (Whitson, 2013), and cultures of production in Toronto and Montreal (Joseph, 2013; De La Rocca, 2013). That same year at DiGRA conference, Parker (2013) provided a thorough summary of the literature presented thus far. In his review, he categorized the independent games studies literature as:

1. theoretical framings of independent games
2. historical research
3. political economy
4. social-cultural studies.

It is the social-cultural studies that most align with this chapter. The work of Guevara-Villalobos (2011) falls in this category as well as the research I have conducted with game designers and other game designer studies.

UNDERSTANDING GAME WORK

Until recently, game work research (Kerr, 2013; O'Donnell, 2014) centered on data derived from direct interviews with game developers (outside of work settings), with scant exploration of the working conditions within companies (Kerr, 2013). Gamework refers to the day-to-day work activities of game developers (Kerr, 2013; O'Donnell, 2014). Of the few studies in the United States that do explore the day-to-day lives of game developers, most of the findings emphasize the console and its respective production network (Kerr, 2006; Whitson, 2012) or aspects of game developer culture, de-emphasizing data about the reflective experience of game developers. Reviews of game developers' day-to-day lives are limited as it is often argued that it is difficult for researchers to enter the inner sanctum of a game studio—mainly due to game studios' hesitancy to share company secrets

and the need to protect their intellectual property (Kerr, 2011; Nieborg, 2011; O'Donnell, 2014). Two studies that do explore game developers' day-to-day lives include the work conducted by Casey O'Donnell who interviewed studios in India and the United States and Orlando Guevara-Villalobos research on game work by independent developers.

O'Donnell discovered aspects of gamework in his ethnographical work studying development practices in game industry includes a work culture driven by instrumentalization, secrecy, and a demographically similar workforce (in terms of race, class, gender, and sexuality). Instrumentalization according to O'Donnell (2014) describes game developer's proficiency in both understanding game play and the underlying technologies that make game play possible. There are two other aspects of game development work that O'Donnell portrays in his study, secrecy and diversity. Secrecy, claims O'Donnell, extends beyond IP to include secrets between different game development professionals (artists and engineers), between organizational hierarchies (managers and leads), and even up the value chain (studios and publishers; manufacturers and publishers). Finally, O'Donnell confirmed the generally agreed view that the game industry lacks diversity of gender, race, age, sexual orientation, and family life (Deuze, et al., 2007; Dyer-Witheford and de Peuter, 2006). While his study did include work with an Indian based studio, and there are literatures about studios in other regions in the world (Japan for example), the people that participate in the industry are homogenous to their respective region. His work also reports on the disproportionate number of men and women working in game development studios (Deuze, et al., 2007; Dyer-Witheford and de Peuter, 2006; O'Donnell, 2008; Johnson, 2013).

Despite the challenges of studying studios, much can be gained from understanding other forms of gamework such as indie gamework. Orlando Guevara-Villalobos (2011) attempted to map independent gamework. He interviewed 12 indie game developers in the United Kingdom and Germany most of whom were recruited from Indies at Cambridge (CB2). Guevara-Villalobos reports that indiework is mix of independent movements from film and other media, as well as hacker culture. He described independent labor as having a spirit of its own and being driven by autonomy, art, and commerce. The indie spirit is characterized by cooperation with other independent game developers, a freedom to develop games on their own terms, and a passion for game development. Indies are committed to being creative, a quality which they report is often lacking in the game industry. The culture of work in independent development is also focused on a meaningful and deep connection with players. Indies also form networks and communities to support one another with tools and open software as well as labor knowledge.

Being indie does not mean that all indies have the same goals, rather indies can focus on:

1. economical rewards
2. experimental approaches
3. emphasize political perspectives through their games.

Guevara-Villalobos (2011) summarizes that two predominant viewpoints dominate indiework culture: the first describes indies as entrepreneurs that prefer the freedom to create on their own terms and the second builds on the first, by exploring the independent viewpoint characterized by a "personal artistic style" which is informed by openness of hacker culture. Hacker culture is defined by:

1. Hands on imperative: Access to computers should be unlimited and total.

2. All information should be free.
3. Mistrust Authority, promote decentralization.
4. Hackers should be judged by their hacking, not by degrees, age or race.
5. You can create art and beauty on a computer.
6. Computers can change your life (and the world) for the better. (Levy, 1984; Raymond, 2000.)

Guevara-Villalobos (2011) also reports that the problem of independent game work often requires adaptation to market conditions curving independent developers' freedom for creativity.

The above research supports the importance of understanding game developers' work and life and aligns not with only Thompson's (1995) view but also with Martin and Deuze's (2009) assertion that "because of the short yet tumultuous nature of the game industry's history, it is necessary to not just study the articulations of the system with the life worlds of its participants (gamers and developers) but also the ways in which developers themselves actively shape and give meaning to their own role within a system that is still very much under development".

In indie game development, new research continues to explore game developers' work and perspectives. Today perspectives include an exploration of indie game developers' views on free to play games and monetization models (Alha, et al., 2014); collaboration and team composition (van Roessel and van Mastrigt-Ide, 2011); issues of privacy and cloning for the creation of independent games (Katzenbach, Herweg and Van Roessel, 2016); iteration in game development (Kultima, 2015) and cultural perspectives of game designers (Sandovar, 2014). Understanding the nature of gamework, provides some methods to understand developers' perspectives on game design and their development process, reviewed in the next section.

PRODUCTION RESEARCH METHODS

Production research methods can be divided into three types:

1. those methods that are utilized to support the macro-level of the games industry: that is an understanding of game production culture and networks of production
2. methods for understanding the meso-level of the games industry such as the organizational and studio culture and
3. methods that explore the micro-level of the industry to include game designers' perspectives on design.

Methods to understand game production culture focus on already existing publications including articles, online journals, trade and web publications, blogs, published interviews by game developers and real time-journals (Kerr, 2017; Martin and Deuze, 2009; Nieborg, 2011). For organizational and studio culture, a mix of methods is employed including ethnographic field notes, studio design documents, blogs, developers meet ups, conferences, game jams, co-working spaces, diary research, published interviews as well as in person interviews (Guevara-Villalobos, 2011; Kerr, 2006; Kultima, 2015; O'Donnell, 2014; Whitson, 2011). To understand design from a game designers' perspective, methods applied so far include semi-structured interviews (Alha, et al., 2014; Guevara-Villalobos, 2011; O'Donnell, 2014, van Roessel and van Mastrigt-Ide, 2011; Sandovar, 2014), drawing and collage (de Smale, Kors, and Sandovar, 2017), and games for design research (Kultima and Paavilainen, 2008).

In what follows, I will propose another type of research method that can be included for the understanding of game designers' perspectives; that is, the use of visual methods such as photo

elicitation. I will briefly review visual methods, describe the research study and methods and conclude with a sample narrative of the design process.

VISUAL METHODS

We live in a visual world. We are surrounded by increasingly sophisticated visual images. But unless we are taught how to read them, we run the risk of remaining visually illiterate. That is something that none of us can afford in the modern world. (Howells and Negreiros, 2012, p.1.)

Howells and Negreiros (2012) highlight the social world as visual, despite the dominance of the written text and the spoken word. They argue that postmodernity is dominated by images (texts)—paintings, photographs, films, advertisements, television, information communication technologies, and new media forms such as social media and digital games—which inform and communicate meaning. Culturally, the complexity of our times—with its imagined communities, it is increasingly networked and changing multicollectivity—is best understood visually. Few, however, understand how the image informs culture in a postmodern world (Howells and Negreiros, 2012).

Perhaps the new social relationships that media propels has much to do with how media is structured. For one, media does not only occur through text or spoken word, much of media including television, magazines, newspapers and the internet, are all steeped in imagery and the visual. Hence understanding the visual communication of media is essential to understanding how human beings relate to themselves and others.

The complexity of media has implications for global social relations and our understanding of design. A multiplex topic which includes media, its production and the implication to culture requires a multifaceted research approach. The use of tools, methods, and approaches from a variety of approaches thus supports a better understanding of what design is, how it is symbolized, how it is narrated, and how it is constructed for participants.

Juul (2014) describes the importance of imagery and visual in independent games. He provides a definition and historical background for the visual style or *independent style* of independent production. He reviewed the history of the independent style from independent games festival from 2000–2014 and divides independent style into four periods:

1. the period between 2000–2004 is defined by smaller versions of bigger budget games
2. the period from 2005–2009 is characterized by 2D pixelated style
3. this is followed by a 3D pixelated style from 2010–2012
4. 2013 the pixelated style is retained with an emphasis on documentary or political perspectives of games. (Juul, 2014.)

The following sections describe the visual narrative approach used to engage participants in reflection about their designs.

USING VISUAL METHODS AS COLLABORATIVE TOOL WITH GAME DESIGNERS

Over two separate meetings, 12 independent game designers from Los Angeles and San Francisco were interviewed about their design process, their background, and their cultural perceptions. The goal of the first interview was to understand game designers' vision for their game and their design process. The second interview was structured to gain a deeper understanding of game designers

background and perspectives on culture. This chapter will focus on narratives and research of the first interview. To gain a deeper understanding of game designers and their creative process, I employed visual methods, photo elicitation, and sketching. As a visual study, this research draws from communication and advertising research (Zaltman and Coulter, 1995) to arrange how participants' interviews are organized. Specifically, methods employed in the research study include cognitive mapping (Butler-Kisber, 2010; Visser, et al., 2005), photo elicitation (Butler-Kisber, 2010; Pink, 2013) and vignette formation (Zaltman and Coulter, 1995; Blodgett, et al., 2011).

Through visual methods I could gain a deeper understanding of the designers' reflective process, specifically

1. how the vision for a game was formed and executed
2. what informed or influenced game designer's path to design
3. how designers described their personal design process
4. how their perceptions or worldview inform their game creation and process.

Photo elicitation

Visual communication literatures claim that mental representations are non-verbal. Mehrabian (1971) proposes that communication is 93 percent non-verbal, Pinker (1994) maintains that mental representations are pictorial and Zaltman (1997) argues that verbal communication is limited in conveying complex constructs. Photographs, then, are a good medium by which to understand and capture symbolic composition. They can serve a reflective approach to understanding culture because they capture visual aspects of symbolic composition. (Pink, 2013). In addition, through images participants can elicit a different definition and meaning of culture than through verbocentric research techniques (Alfonso, Kurti and Pink, 2004).

In this study, image elicitation serves as a tool for visual narrative, self-reflection, and elicitation (Butler-Kisber, 2010). First, as an altered *photovoice*, known as participatory photography (Wang and Burris, 1997), image elicitation facilitates game designers' responses and deepening of their self-understanding about culture (Pink, 2013). Second, by coaching game designers to arrange images in cognitive maps (digital collages as described below), image elicitation becomes a collaboration tool that supported their self-reflection of social and cultural constructions (Butler-Kisber, 2010). Third, image elicitation functions as a visual narrative of both participants' game design choices and their autobiographical stories about culture (Bach, 2007; Butler-Kisber, 2010).

ZMET: Cognitive mapping

To probe participants' understanding of their game design process and thoughts about systemic patterning and learned transmission, cognitive mapping techniques and specifically the Zaltman Metaphor Elicitation Technique (ZMET) were employed. The method was created by Zaltman and Coulter (1995) to better understand the mental models that drive consumer thinking and behavior. Another purpose of the model was to construct actionable mental models about consumer behavior. ZMET is a tested and organized method to collect information about participants' perceptions about a topic. The final step of ZMET is a vignette that illustrates participants' narrative construction about a topic.

The steps are as follows (Zaltman and Coulter, 1995):

- *Storytelling*: Participants collect images representing the topic and then explain how each image reflects their view on the topic at hand.
- *Missed issues and images*: Participants are asked if there are any ideas about the subject, not currently represented in their picture selection.
- *Sorting task*: Participants sort the images into meaningful piles and name each pile.
- *Construct elicitation*: Utilizes a contrasting technique where participants select two or more images and contrasts images with each other.
- *Most representative image*: Participants select one image which most represents their view on the topic.
- *Opposite image*: Participants are requested to select an image that is the opposite to the topic.
- *Sensory image*: Participants are asked to describe images that represent and do not represent the topic by using their senses including touch, smell, taste, sound, color, and emotional feeling.
- *Mental map*: The interviewer reviews the perspective of the participant, asks if anything is not present in the summary, and then requests the participant to create a mental map that summarizes their thoughts about the topic.
- *Summary image*: Participants use their images to create a final montage about the topic.
- *Vignette*: The participants create a vignette or video describing their feelings about the topic.

For this study, the steps were considered carefully as not all the steps may be appropriate for game designers. Unlike advertising research, participants in this research were not paid for their time and thus the length of time needed to complete the ten steps was unrealistic. In addition, not all these same steps were helpful to understand game production. Finally, the end goal of ZMET is to find themes among the participants to make changes to branding and advertising. The goal in this research is not to uncover themes between game designers' narratives but rather to describe game designers' individual experiences through a vignette. Therefore, an altered ZMET was employed which included:

- *Pre-meeting preparation*: Participants collected personal and game images that represented meaningful aspects of their game. An email was sent which asked participants to: (a) select a game that is meaningful to them; (b) select 10 or more personal images that represent meaningful aspects of the game; (c) select 10 or more game elements (including audio, images, and video), that represent key mechanics or game play of the game; and (d) save these items in a dedicated google folder for later review.
- *Design storytelling*: In 60 minute interviews (in person or through skype), participants described each of the saved personal images they collected and explained why these are important aspects of their game. Participants also described each of the game images (or other media) and explained how these relate to their game.
- *Missing design image*: Participants included or drew an image that was important to the design of their game but for which they did not have an image.
- *Cognitive design elicitation*: Participants described in words elements outside of their control that influenced the design of their game.

- *Design verification*: Participants were asked to take game images and words and pair them with their personal images by creating new folders in Google drive. Participants named each of these folders with a name that best represented the cluster of images. Participants explained the relationship between the two.

Narrative vignettes

Vignettes have been used to present participant's voices (Ely, et al., 1997), collect research data to understand the experience of patients during hip replacement (Spalding and Phillips, 2007), and to give voice to aboriginal stories (Blodgett, et al., 2011). Ely, et al. (1997) explained that there are three types of vignettes available to the researcher:

1. *the portrait* captures a participant's perspective by narrating the vignette through the voice of the participant (written in the first person)
2. *the snapshot* describes observations made by the researcher about participants (usually written in the third person)
3. *the composite* includes a descriptive narration of participants' experiences, observations by the researcher as well as an analysis of those events.

In this study, vignettes included composite descriptions. The participant's perspective as well as observable aspects by the researcher were captured in the narrative. In addition, the vignettes contained visual images as part of the narrative construction.

The game design portion of the vignette was organized as follows:

1. About the designer
 - Who is X (designer)?
 - How did X (designer) become a game designer?
 - How does X (designer) see the world?
2. About the game
 - How is X (game) designed?
 - What was the inspiration for X (game)?
 - What was the design process for X (game)?
 - Reflection on game design
 - What is the future of X (game)?

JOHN'S GAME DESIGN NARRATIVE

John's narrative is one of the designer narratives created during the research study. The narrative is composed of two halves, a game design narrative and a cultural narrative. For the purposes of this chapter, the game design narrative is shared to highlight what designers reflect on when designing a game. As described above, design narrative is divided into two parts: a) about the designer and b) about the game. The first part describes John's reasons for becoming a designer and the second describes his process for the design of his game *Gorogoa* (2017).

THE DESIGNER

John is an independent game design and visionary of the game *Gorogoa* (2017). I met John during Indiecade while having lunch with a few game developers. He was immediately intrigued by the idea of self-reflecting about his work. We met at GameNest in San Francisco and later in Berkeley to discuss his work, his worldview and his background. John has gentle and quiet demeanor, and he comes across as a deep and reflective thinker. He has brown hair, wears a short beard and glasses. John describes himself as someone that spends a lot of time lost in thought. In a moment of discussing some aspect of his work, he pauses and exclaims:

I lost that thought it probably just means that I spend a lot of time lost in thought which is maybe good for the creative process but it has a downside that I'm not always paying attention to what's going on around me which means I'm gaining less from direct experience than I could be.

John grew up in Idyllwild, California, a small town where celebrities lived. However, he does not have a small town mentality; John has spent a considerable amount of time traveling the world and enjoys learning and experiencing other cultures. His travels around the world also played a large role in the creation of *Gorogoa*.

I think I'm just going around the world and seeing different places, different textures accumulate in your mind. And also different beliefs and figuratively, I'm interested in what people believe, again, about the unseen world.

This may have fueled his interest in religion and rituals. Even though he moved away from religion, spiritual concepts are still an important part of John's life. Particularly he sees art, and specifically video games as a place where he finds hidden meaning. He sees his role as one that supports the player to uncover a purpose in video games that is missing in the real world.

I drifted away from my religious faith but it's always been important to me and I think some of the things I like about—I think some of the things that I'm seeking from these structures, things like video games is that they create a world with a hidden meaning that you can uncover and underline rules and purpose that are missing from the real world. So, it's something that religion didn't do what it was supposed to do for me but it remains something that I found very compelling and I see it as something that—it says a lot about what people want and what they need. And those who want and need manifest in ways other than in the explicitly religious. I think there are many things that people do that are serving the same needs as religion and that's part of what art does I think.

John also sees safety in small zoomed-in worlds and sees this safety as part of his attempt to escape the outside world. He does not feel like he belongs to the outside world when he shares his vision for *Gorogoa*:

By zooming in on a small, self-contained world. I don't know—I think there is some safety there. That's why I put anxiety too—seeking out these little, enclosed, protected conceptual spaces is an attempt to escape the big, bad world and outward looking—I think I was trying to capture the idea of dissatisfaction with the world or the culture that I found myself in. And looking outward to other places or other cultures real or imagined an attempt to find something that was presumably missing which is a weird counterpoint to the idea of the microcosm I guess.

How did John become a game designer?

John's journey to game design, was by no means direct. Unlike other designers, he did not draw or explain a path, instead he describes his journey as a small cluster of experiences that influence him today.

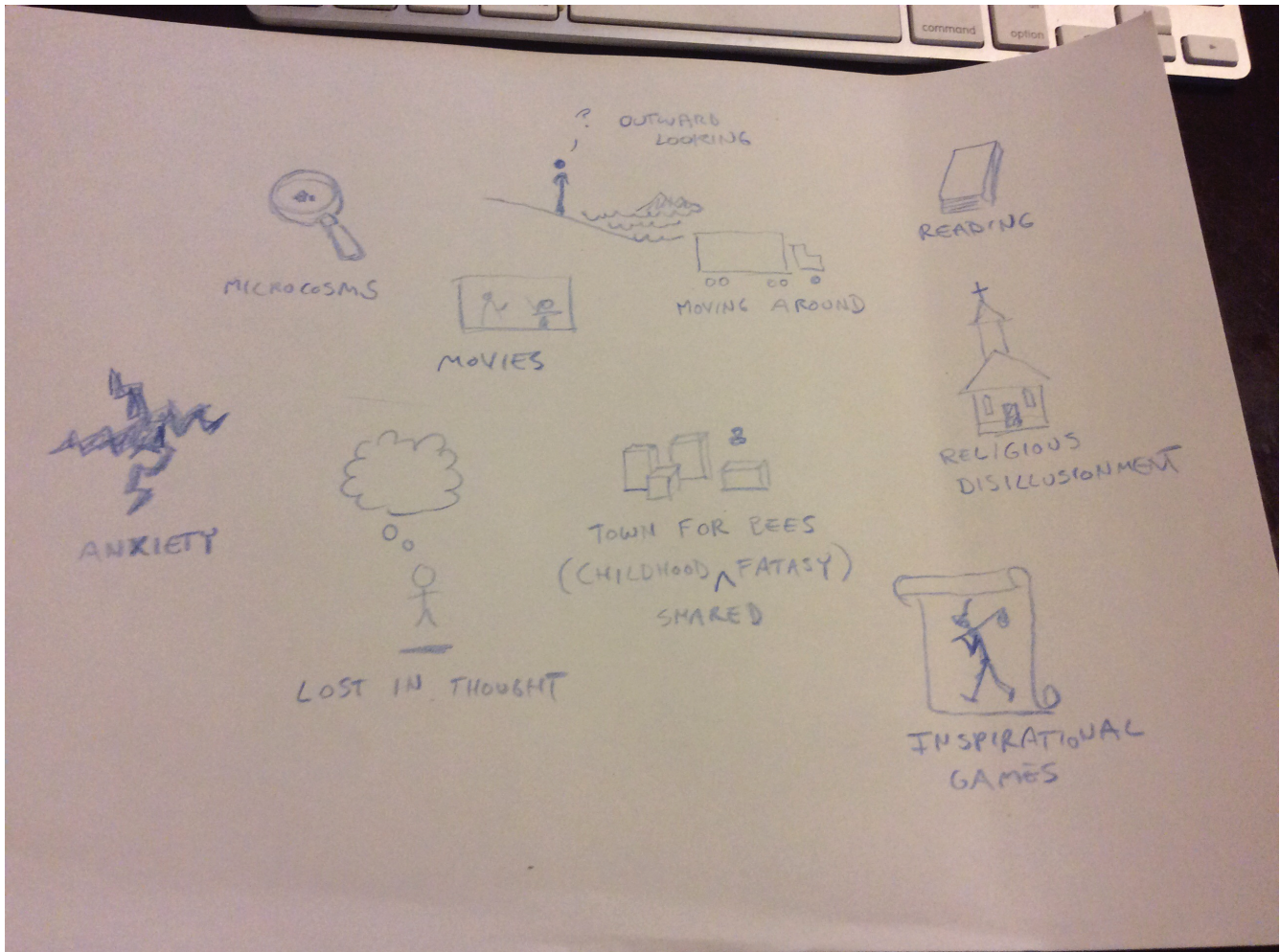

Figure 1. John's drawing of his path to becoming a video game designer which includes religious beliefs, moving around, inspirational games, his town for bees, movies, as well as his internal world of anxiety, microcosms and lost in thought.

John explains that his roots for game design date back to his childhood days: when he was young he used to imagine games that were puzzle boxes and imagined stories embedded in that puzzle structure. This also helped him think about constructing worlds. He recalls a childhood fantasy about a constructed world for bees:

It was something that popped into my mind from childhood when my friend and I would have this idea that we would build these paper towns for bees and then capture individual bees and release them into the town and they would live there. I don't know. But it was the first time I remember constructing something that elaborate and it was a shared collaborative sort of fantasy with my friend. I don't know how old we were. We were probably eight or something. So that represents the constructed world sort of constructed for an audience that we never actually put in there and why it was a bee was just some childhood fancy I suppose.

Later, John attended university at University of California, Berkeley, where he was exposed to many different ideas and courses. John took it upon himself to study many different subjects including Scandinavian literature and physics before choosing to study computer science. These courses sparked a plethora of design ideas which he refers to as quite complex and probably not executable. John began to think about elaborate game designs and structures, these puzzle structures had cities and buildings inside of them, much like the bee structure from his childhood days.

It's the idea of there being secret meaning deep patterns and signals that I'm more likely to perceive in these very complex and intricate scenes or constructions that suggest that they're about something under the surface that you can't quite put your finger on and that's what I'm seeking out as a human need.

John's journey to game design was also deeply influenced by movies, books, and travel. He recalls the theater in his hometown Idyllwild as one of the first places where he was exposed to fantasy. An important movie for John was the 1982 science fiction cult classic, *Blade Runner*. He was very connected to this movie because of the mood it evoked and represents for him the influence of cinema on video games.

In the last few years, John began experimenting with interactive media. He gave himself a goal to work on different puzzles every day for inspiration, then suddenly, during a visit to the Monterey museum, a view of a seahorse crystallized the idea for him, and he began designing his first digital game, *Gorogoa*.

How does John see the world?

John experiences the world deeply and sees mystery in everything. Throughout the interviews, he shared images that represented aspects of fantasy and the mystical. He also has a deep reverence for sacred places, such as churches and religious sites:

This is Rocamadour in southern France and it's also a religious site. It's a pilgrimage site and it's just a place that I saw once traveling and really stuck with me. I remember taking a long hike that may have been along the pilgrimage route and you round the corner and you see a glimpse of this town built into a hill and it was a profound experience.

John also views the sacred extending to landscapes:

I don't know where this theory came from but there's this idea that there are desert religions and forest religions and that they have different character. I was climbing to the top of Mount Sinai with my parents and my dad or mom looking around at this landscape. It was completely barren, it looked like Mars and he said that it's no wonder the prophets thought in absolutes because it was such a merciless landscape and sometimes I wonder if the religions that were born in the desert, Judaism, Christianity, and Islam are more rugged like plants or animals that evolve in a harsh climate and that's why they spread so readily.

In contrast to the visible sacred places, he also notes how this sacredness exists in the mind:

But my dad always used to say that everybody has a landscape in their head. It's where you feel like you belong. It may not be the landscape that you were born into but it's the one that sort of feels right or makes you feel something. I mean there are many beautiful landscapes that I've seen but not all of them have the same feeling of profundity.

He refers to this invisible mind space as psychic space which he connects to loneliness and sadness. He describes this perfectly when he speaks about a landscape in Wales:

I'm interested in this idea of the psychic landscape thing that you have in your head that appeals to you, it means something to you and I like that sort of—I don't know—this is beautiful but it's also otherworldly. It looks a little bit like the surface of another planet. The colors are a little bit not quite the lush green that you associate with pastures in Wales and it has a loneliness to it, which appeals to me.

GOROGOEA

Gorogoa is a narrative driven puzzle game. In it the player moves around tiles to complete puzzles that construct a story. John describes *Gorogoa* as a:

[...]a comic project, something project-like and has multiple narrative frames that are part of a single composition. And they somehow interact with each other.

To play the game requires rearranging the tiles one upon the other in a sequence. When a tile is placed upon another successfully the story progresses and another tile or aspect appears. Each step requires a new puzzle to be solved. As the player solves each small puzzle a new scene appears, the player can then progress and view more of the story.

How was *Gorogoa* designed (gameplay)?

There are four elements to the design of *Gorogoa*: the narrative, the main mechanic, the development of the puzzles, and the visual design of the game.

The narrative

The player begins with one single tile in which a view of the city appears, in it the main character *Gorogoa* appears in the background hidden by the urban landscape. The player is prompted to zoom out. While zoomed out, the player can then see a child trying to understand the picture he sees (the creature in the landscape). The page suddenly transforms into four tiles, one of which is the beginning tile. From there, the player is prompted to split the first tile into two. This begins the story of the game as the tiles have individual story plots which you can zoom in and out, to connect with other tiles to create a cohesive story.

The narrative in the game is about devotion, and how adults and children view this concept differently. It is about the relationship between one human being and a god or between a god and human ideas. It is between the self and a higher element. It is between a character named *Gorogoa*, which resembles a god, and a young boy.

I mean the story is a little bit solipsistic, I guess. I mean it is about a character who is sort of like a mystic in a way that he devotes himself entirely to finding something that's outside the world, which seems like it's about escapism in a way or abnegation.

The core mechanic: Puzzle tiles

He drew inspiration for the game play from two writers, Christopher Manson and American Cartoonist Chris Ware. For John Christopher Manson's (1985) puzzle book, *Maze* inspired the ideas of puzzles. *Maze* is a book that is designed to look and behave like a building where each page is a different room. The doors are numbered which tell the reader which page to go to. The object of the book is to find the quickest path to the center of the maze. John loved the ambiguity of the Maze and also the handcrafted feel of the images.

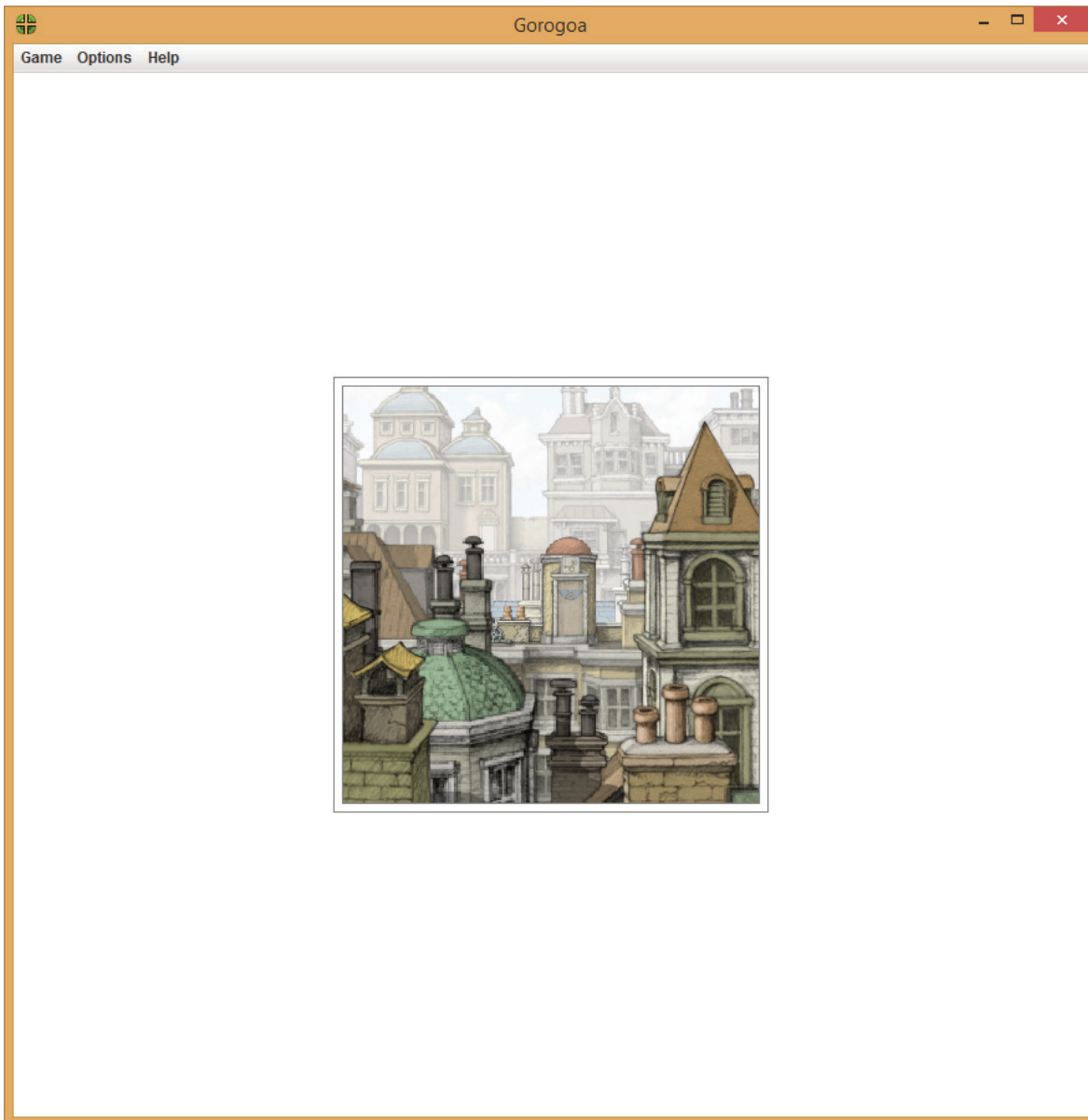

Figure 2. The beginning scene of *Gorogoa*.

It was this sort of interaction that he wanted to create with *Gorogoa*. He wanted to create a comic project with multiple narrative frames that would interact with one another. He also needed to create some restrictions:

Right, so there are only four spots. The game has to prevent them from ever splitting too much, so there's one in four. So and that was a big design constraint. You have to make sure the tile goes away. Like if it's reabsorbed, so they don't just start populating.

Another inspiration for the game play were the cartoon compositions of Chris Ware, an American cartoonist. These scenes have a lot of information in one picture; the cartoons have narrative sequences interacting with one another in a complex, intricate way.

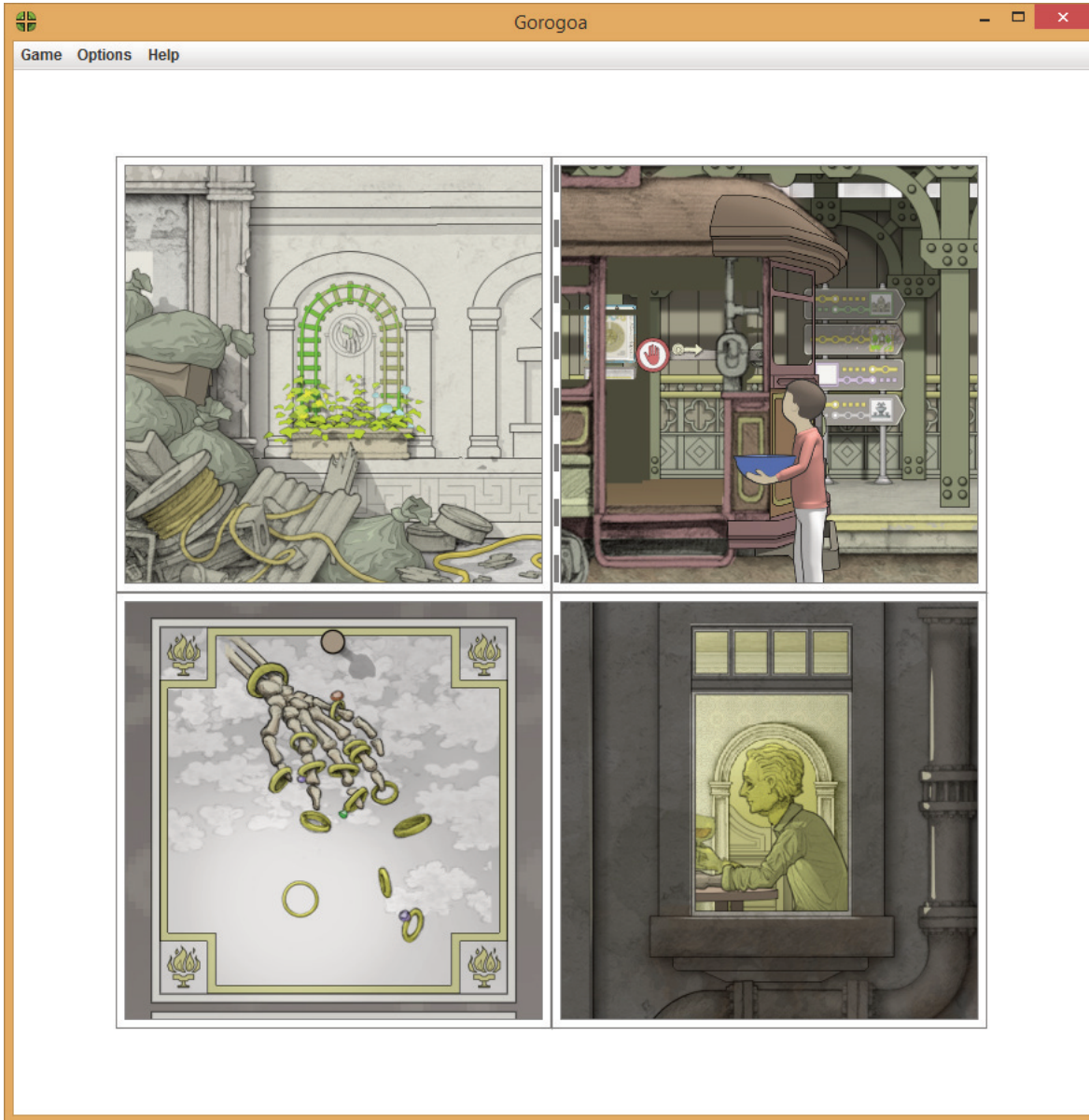

Figure 3. A sample of the puzzle mechanic of *Gorogoa* game play.

So in the game you have these different panels or windows that are different scenes, but you have two things that should be two separate scenes that can bleed into each other and affect each other, like it's windows on a desktop or something. You've got two different applications running, but they can somehow cross the border and interact with each other. That was one of the core ideas, I think.

John explains the complexity and interplay of the tiles:

So again, you see a lot of the scenes become very complex, like this scene with the pictures on the wall. You can, because it's interactive, you can click and zoom in on each of them, and zoom up the picture and then you can go inside each picture. And then on this bookshelf, each one of these books you can zoom in on and then see this picture this wall, these images, although a lot of it's temp art still, but it's supposed to be images in the character's life and you see the character himself. And these articles here are part of a ritual that he's been performing.

Visual theme

The imagery of *Gorogoa* was inspired the ornate designs in temples, shrines, and architecture. John refers to the Alhambra, a palace in Granada, Spain, constructed by the Moors in 889 AD as a significant influence. He points to a hand drawn image by Gustave Doré, an illustrator, in the 19th century. There are patterns and intricate arches, with details that become more and more intricate as you zoom in.

Gorogoa has this type of disembodied experience where zooming in while continually providing more details.

And here we see, this is a scene that helps capture the variety of visual textures and scenes within scenes to some extent, the image of—this is the eye of *Gorogoa* right here that again, has that very—you can see those decorative motifs like before.

Another inspiration for visuals came from Owen Jones' (2008) *The grammar of ornament*, a book originally published 1856 cataloguing the ornamental styles used throughout the world in carvings. The intricate features came from ancient towers like the Mudejval and Saheli Yo Ki Badi.

So I had a big folder of towers, and there's a tower in the game. They, I think again, they're about being high up above everything else, but also contained in this very small space. And I think I'm attracted to the idea of a microcosm or something contained but that's in a much larger, open world.

The creation of detail in the game was key to the design for John:

Yeah, and when you are making a game or anything where you create everything, whether it's hand drawn or in 3D, you have to make everything, meaning you have to make buildings and then the decorations on buildings, and then the wallpaper and on and on. I mean in some cases I think certainly people just go out and grab real world samples, but one of the things that attracted me is to be able to design all of that stuff.

He describes the variety of visual elements in *Gorogoa* and the various influences from various cultural experiences including multicultural festivals and ritual images. *Gorogoa* is full of cultural and religious rituals:

Then this is a scene that sort of mimics an illuminated manuscript or something, and also has some influences from Asian imagery, Mezzo-American [sic] imagery, and this again, you think of that image from the festival, the Japanese festival is bright colors as an imagining of the fantastical.

John interestingly notes that while he often tended to favor black and white in his drawings, introducing sacred and multicultural elements into the game required more color:

But I use color a lot in this game. And part of it is the reason I like images like this is because of this kind of exuberance of people's imagination of the invisible world, the sort of spirit world, and that's what they're sort of building this model of, a little chunk of the world beyond the invisible universe. And I love all these colors that are all in one place, but they're structured. And yeah, this energy that's part of this festival.

What was the inspiration for *Gorogoa*?

The main creature in the game, *Gorogoa*, was inspired by a leafy sea dragon that John saw once when visiting the Monterey Bay Aquarium:

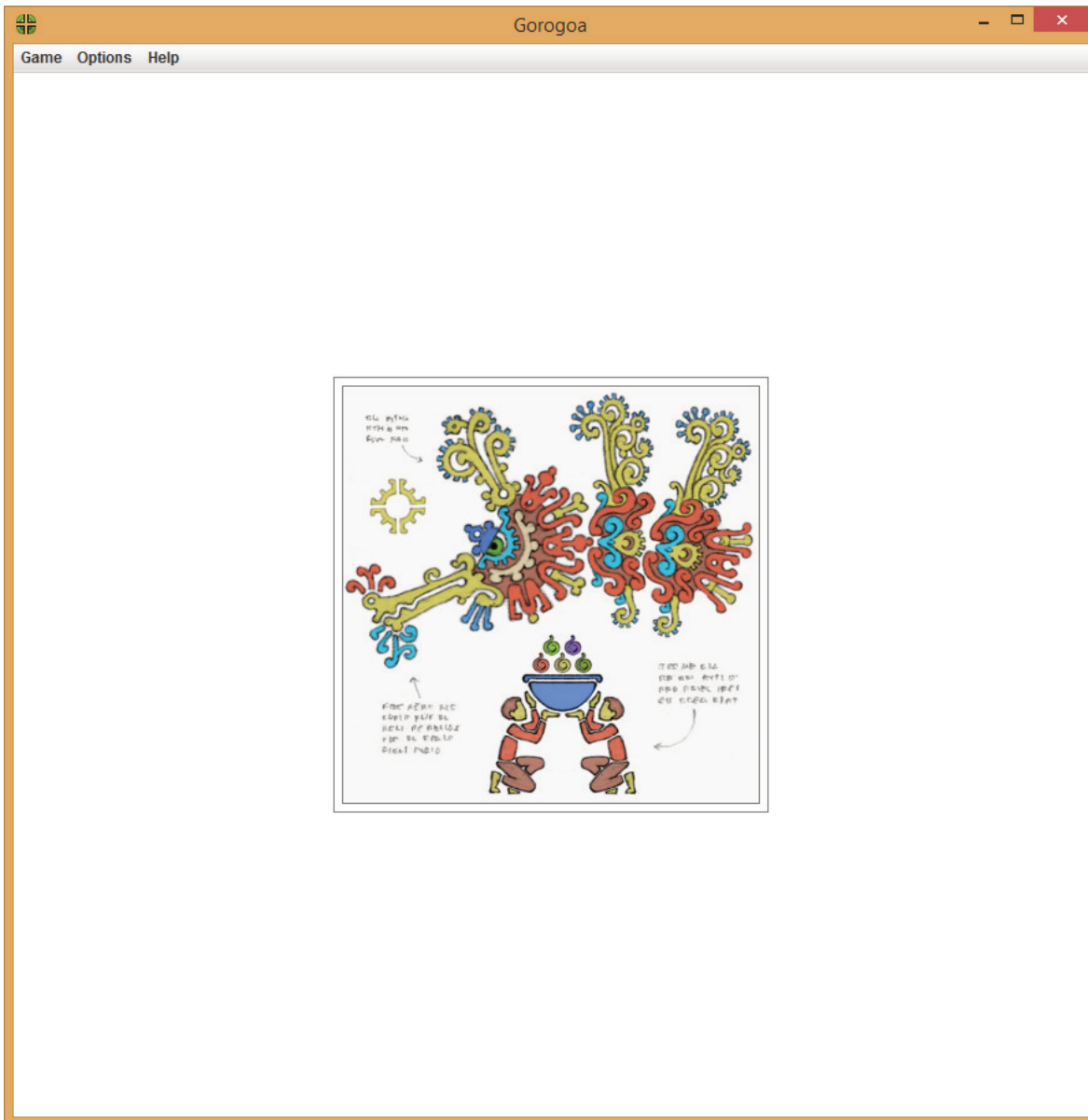

Figure 4. Image in *Gorogoa* that has Mesoamerican and Asian influence.

I saw these sea dragons in a tank there and I thought that it felt like something strange, otherworldly. It seemed like something fantastical and that shouldn't be alive. That somehow came together with the idea of the game of having glimpsed something magical and then lost it and trying to get it back.

Another creature that inspired the game narrative was the hippocamp:

Yeah. Well, anyway, the idea of splicing and recombining is an important feature of the game, and the image of hippocamp is one that's used repeatedly. And yeah, this just feels like something out of—it is an illustration from a fairytale, I presume. I think that's a Bible story.

In addition to the visit to Monterey museum, John drew inspiration for *Gorogoa* from novels, movies, games, and travel. Two authors influenced his work, Phillip K. Dick, a science fiction writer from the United States, and Kurt Vonnegut, another American author. His lifelong obsession with puzzle

games also plays a role in the design of *Gorogoa*, in addition to Christopher Manson' puzzle book, *Maze*, and the cartoon compositions of Chris Ware.

Well, I've really wanted to work on some sort of creative project all my life, and there's something about games, or more specifically, puzzles that I find compelling. I thought about this a lot, but why the idea of puzzles is interesting, I think for me it's a fantasy of like there being hidden or in the world, so that there are hidden patterns and possibilities all around you have to work to find.

John's inspiration for the puzzles in *Gorogoa* came from the 1987 game, *A fool's errand* (Johnson, 1987), a multi-puzzle narrative game designed by Cliff Johnson. *A fool's errand* fascinated John because of the multiple layers of meaning.

The game has puzzles and secrets that need to be assembled into squares which each in turn become a higher-level puzzle. He describes the game's influence as:

This was from an early era in video games where people tried lots of different things and didn't know what a video game was yet or how to make one exactly and this had a sense of mystery to it in that it was very cryptic and kind of allegorical and it was based on the tarot which is already kind of steeped in mystery and an implication that you never quite feel like you have a full handle on.

John also wanted *Gorogoa* to have a contemplative mood. He drew the idea of the mood from the horror game *Silent Hill 2* (Team Silent, 2001), and from American painter Edward Hopper, an American realist painter from the 20th century, to create a wistful visual feeling with multiple textures. *Silent Hill 2* is a third person horror game which uses riddles and psychological terror. Though it was the underlying sadness in the game that helped John understand the many layers that games could have:

So I think it was deriving—I think a lot of horror is derived from other negative feelings that are translated and represented by monsters trying to attack you. But this is—it had such a strong sense of place and atmosphere that it persuaded me what videogames are capable of.

A final inspiration was John's personal drive to develop his game development skills:

And I wanted to do something that used all the abilities that I have. I'm an engineer, but I also like to draw, and I may not be the best at any of those things, but if I can find something that combines all the things that I'm good at, that gives me an advantage over just being in one particular field.

What was the process of *Gorogoa*?

John spent many days in coffee shops thinking of ideas and writing stories. At that time, he was working on an interactive project with game like features, while he was also attempting to create a web comic. Although he refers to it as a failed web comic since it took 20 hours to create a page and he never finished the project. Then inspiration hit when he visited the Monterey Bay Aquarium and saw a sea dragon. Shortly after he started working in isolation:

I initially had some notion of an interactive comic page with multiple panels on it, where you can move parts from one scene to another, and maybe characters can interact with each other between the panels or the same character at different points in time. And that went through a process of you elaborate on an idea and then you try to boil it down, and elaborate on it and boil it down. It ended up at a very, very simple what I thought was the minimal possible version of that concept.

Once he had the idea for the game, he explored different exercises to help him practice producing puzzles before designing the game.

So before I was working on the game, I was going to do a drawing every day because that gave a little bit more structure and a goal. Then I decided I want more structure, so I said within each month, which is a sequence of roughly 30 drawings, there's gonna be a puzzle embedded in that sequence, like of the 30 drawings, you must pick 7 and put them in the right order as the solution.

Next John puts these puzzles together while challenging himself to make these visually appealing:

So I built—that was like a prototype game in a way. I had visual art, but it was a puzzle that had a solution. And I found that very satisfying, and I also felt like I was improving as an artist by making myself do all this work, which I never would have done without that structure. So, it was a framework to allow me to produce a bunch of art, among other things.

It was also important for John to do the artwork himself. That was a challenging and rewarding process:

And it's like I say, it's a huge time sink and I have to keep it simple, but I love doing wallpaper in the game, the architectural decoration and things like that. And this also made me think of illuminated manuscripts probably would have used. Yeah, I should've just grabbed an image, but again, it has to do with intricacy. In the case of illuminated manuscript, like all the intricate detail is a map of devotion in a way of communing with the divine, so it has intricacy. It has spirituality, I guess.

Then in 2012 he presented *Gorogoa* at Indiecade. He had a great experience and the response about the game was favorable. After that he spent years trying to find the magic in his game, and what people liked about it:

And I didn't know, I built a bunch of stuff without thinking it through entirely, so I spent many years building stuff, deciding it didn't work, throwing it out, backing up and trying something else, but now I feel like it's finally come together, at least I'm going to release what I've got.

He supported the project through his own funding, then eventually received financial support from an Indie fund and from his family to finish *Gorogoa*. Eventually all the pieces came together.

Reflection on game design

John grouped the important elements of the design of *Gorogoa* into several values: Chimera Labyrinth, strange and disorienting, intricate special narrative machinery, sacred architecture, colorful imagining of invisible worlds, mood and natural wonders.

Spatial narrative machinery refers to the actual mechanic for the game, the way the puzzle is designed and how it functions has a history in Chris Ware's narrative structure but also visually captures the feel of a comic book. This reminds him of the layers and patterns that he wanted to create in *Gorogoa*.

Yeah, I think well, seeing the patterns. Maybe that's what we've already discussed, seeing the patterns in the imagery, which I didn't think about that much.

Colorful imagining of invisible worlds refers to the many sacred and ritual elements John has introduced in the game these include the elements of festivals and the Mexican influenced paintings in *Gorogoa*.

And like I say, those pictures from the Alhambra go all the way back to when I was traveling there, and to see it all as connected.

Sacred architecture includes the intricate designs from the Alhambra, the designs from *The grammar of ornament* (Jones, 2008), and the ancient towers of Mudjeval and Saheliyon-ki-Badi.

One of the things that was eye-opening about looking at the pictures was seeing how the temple pattern looked like the game, it has many cells like the game, and I didn't see that until I looked through them. And [noticed that] ideas from each of those drawings is really of multiple themes.

Mood and natural wonders referred to the landscapes he discussed as well as the sea horse that inspired *Gorogoa*. Scenes from *Gorogoa* that represented a somber feeling were also included as well as the crowded urban landscape:

The game is really set more in an urban landscape and it's something that I derive pleasure or displeasure from as I walk around. It's very omnipresent, it's accessible, it's available to everyone who is outside. I think it has a big effect on the way people feel as they're walking around. You're always traveling from point to point and the built environment around you has a big impact on your mood.

The Chimera labyrinth (strange and disorienting) refers to the most invisible aspects of the game, those that involve the puzzles themselves, the hippocamp (representing the splicing that occurs in the game). He summarizes the game as:

So it is in a way a kind of escape, so a kind of fantasy; and rather than being fantasy about being powerful, it's fantasy about the world. And I think this is true of a lot of these, part of the appeal about puzzle games beyond it just being a challenge, an intellectual challenge, I think there's something, a reason why people are fascinated by these things. I don't know, why are people fascinated by contraptions or given a mechanism, why do people want to play around with it. I don't know.

What is the future of *Gorogoa*?

John received funding to extend his current four-year project and found a publisher in 2016. *Gorogoa* has been released in Steam and the Apple store. For more information and to play *Gorogoa* visit www.Gorogoa.com

DISCUSSION

The visual approach presented provided effective methodological tools for collaborative reflection with game designers and other cultural creators. Visual methodology can be used for reflection on a variety of concepts and processes. Such a research inquiry therefore yielded themes in each of those three areas and respective conclusions. Insights were gained about: (a) production in independent game design; (b) designers' design process, and (c) the values that inform game designers' work.

INDIE GAMEWORK

Guevara-Villalobos (2011) described independent labor as being driven by autonomy, art, and commerce. The narratives in this research study confirmed an independent spirit within the independent game developer community. Game designers described having control over all aspects of game development, even if some aspects were delegated to others on a team. The decisions on what to develop, how to develop, how long to develop, and in what direction to develop were driven by each designer's' creative drives. Another strong component to indie labor was the influence of art and

media (Guevara-Villalobos, 2011). Designers described being influenced not only by previous games but also by literature, graphic artists, film, exhibitions, and music. As John described his work was informed by art and comics, including the work of Edward Hopper and Chris Ware.

Two aspects of indie labor which were not directly addressed by the main research question but arose during the interviews were *sustainability* and *community*. In every interview game designers described the central role of their relationship with the independent game community. The strong relationship between indies and their communities was also documented by Guevara-Villalobos (2011). His findings described the importance of collaboration to indie gamework. Economic and political structures are connected to the communities of people (both players and designers) that make up indie work. For John, community was the center of his cultural construction, the cornerstone of his belief system. He mentioned several times the importance of the indie community for resources, inspiration, support, and work space.

DESIGN PROCESS AND VALUES

The research methodology utilized in this inquiry supported game designers' reflection about their game design process. Incorporating a visual method circumvented designers' difficulties with communication (Lawson, 2006) or expressing the flow of the design process (Schön, 1983). Drawing their design journey and background, as well as the selection of images, supported ease of conversation and reflection about their designs. While game designers had some level of awareness about their work, drawing their process and their journey as designers defined their personal values. In addition, through the process of photo elicitation designers could establish the principles for their game (Lawson, 2006). For example, John found his guiding principles to be chimera labyrinth, strange and disorienting, intricate special narrative machinery, sacred architecture, colorful imagining of invisible worlds, and mood and natural wonders. John did not realize that these were his guiding principles for the game until he reflected on how to group the various elements of the design together. This reflects Lawson's (2006) view that these guiding principles are malleable and are in a dialectical conversation with the ever-changing design situation.

Narrative stories showed similarities to design literature describing that designers' drive for their work arises out of childhood experiences (Lawson, 2006). John recalled not only playing inspirational games but also constructing a town for bees. Game designers also drew from their many experiences to construct toolkits for their design (Lawson, 2006). These included the formation of networks and communities to support one another with tools and open software (Guevara-Villalobos, 2011).

Finally, as part of the reflection designers defined and explored their design process. Each designer described a unique and complex design process as echoed by Lawson (2006) who states that there is no single design process. Differences in approaches may arise from what Schön (1983) describes as the unique appreciative systems each designer embodies or holds. Though factors such as professional experience, education, and company specific design processes still require evaluation, these findings also indicate that the approach designers take may be influenced by their cultural background.

CONCLUSION

Through visual methods and vignette analysis, we can gain insights to game development processes using designers narratives on design and game development. This study contributes to scholarship by highlighting the processes that can shape game designers' perspectives and how these may indirectly shape the phenomenal field of game production. The study reflects more than the relationship

between concepts, it is a narration of what matters to the people influencing our culture today and how they came to be. Ultimately, insight into this construction can assist in understanding how game content and play experiences are created.

BIBLIOGRAPHY

Alha, K., Koskinen, E., Paavilainen, J., Hamari, J. and Kinnunen, J., 2014. Free-to-play games: Professionals' perspectives. In: *Proceedings of Nordic DiGRA, 2014*.

Anderson, B., 2006. *Imagined communities: Reflections on the origin and spread of nationalism*. Verso Books.

Anthropy, A., 2012. *Rise of the videogame zinesters: How freaks, normals, amateurs, artists, dreamers, drop-outs, queers, housewives, and people like you are taking back an art form*. Seven Stories Press.

Appadurai, A., 1996. *Modernity at large: Cultural dimensions of globalization* (Vol. 1). University of Minnesota Press.

Bach, H., 2007. Composing a visual narrative inquiry. In: D.J. Clandinin, ed. *Handbook of narrative inquiry: Mapping a methodology*, Sage.

Blodgett, A.T., Schinke, R.J., Smith, B., Peltier, D. and Pheasant, C., 2011. In indigenous words: Exploring vignettes as a narrative strategy for presenting the research voices of Aboriginal community members. *Qualitative Inquiry*, 17(6), 522–533.

Brey, P., 2004. Disclosive computer ethics. In: R.A. Spinelleo and H.T. Tavini, eds. *Readings in cyberethics*, 2nd ed. Jones and Bartlett Publishers, pp.55–66.

Butler-Kisber, L., 2010. *Qualitative inquiry: Thematic, narrative and arts-informed perspectives*. Sage.

Champagne, C., 2013. *How Pac-man changed games and culture*. Available at: <<http://www.fastcocreate.com/1683023/how-pac-man-changed-games-and-culture>>.

Coulter, R.H. and Zaltman, G., 1995. Seeing the voice of the customer: Metaphor-based advertising research. *Journal of advertising research*, 35(4), p.35.

Camus, A., 1942. *The stranger*. 1946. Trans. Stuart Gilbert. Vintage.

Della Rocca, J., 2013. The Montreal indie game development scene...Before Ubisoft. *Loading... Journal of the Canadian Game Studies Association*, 7(11), pp.130–132.

de Smale, S., Kors, M.J. and Sandoval, A.M., 2017. The case of this war of mine: A production studies perspective on moral game design. *Games and Culture*, online first. DOI=10.1177/1555412017725996.

Designer. X., 1997. *The scratchware manifesto*. Available at: <<http://www.homeoftheunderdogs.net/scratch.php>>.

Deuze, M., Martin, C. B. and Allen, C., 2007. The professional identity of gameworkers. *Convergence: The international Journal of Research into New Media Technologies*, 13(4), pp.335–353.

- Dyer-Witheford, N., & De Peuter, G., 2009. *Games of empire: Global capitalism and videogames*. University of Minnesota Press.
- Ely, M., Vinz, R., Downing, M. and Anzul, M., 1997. *On writing qualitative research: Living by words*. Falmer Press.
- Fisher, Stephanie J. and Alison Harvey., 2013. Intervention for inclusivity: Gender politics and indie game development. *Loading... Journal of the Canadian Game Studies Association*, 7(11), pp.25–40.
- Gamasutra, 2013. *The state of the industry report*. Available at: <http://www.gamasutra.com/view/news/187292/GDC_State_of_the_Industry_research_exposes_rise_of_indies_smartphone_games.php#.US9zc1dvBYg>
- Guevara-Villalobos, O., 2011. Cultures of independent game production: Examining the relationship between community and labour. In: *Proceedings of DiGRA 2011 Conference: Think, design, play*.
- Howells, R., and Negreiros, J., 2012. *Visual culture*. Polity.
- Jahn-Sudmann, A., 2008. Innovation NOT opposition the logic of distinction of independent games. *Eludamos: Journal for Computer Game Culture*, 2(1), pp.5–10.
- Johnson, C., 1987. *The fool's errand: A fantasy puzzle*. Miles Computing.
- Johnson, R.S., 2013. Toward greater production diversity: Examining social boundaries at a video game studio. *Games and Culture*, 8(3), pp.136–160.
- Jones, O., 2008 [1856]. *The grammar of ornament*. A & C Black Publishers Ltd.
- Joseph, D., 2013. The Toronto Indies: Some assemblage required. *Loading... Journal of the Canadian Game Studies Association*, 7(11), pp.92–105.
- Juul, J., 2014. High-tech low-tech authenticity: The creation of independent style at the Independent games festival. In: *Proceedings of the 9th International Conference on the Foundations of Digital Games*.
- Katzenbach, C., Herweg, S. and Van Roessel, L., 2016. Copies, clones, and genre building: Discourses on imitation and innovation in digital games. *International Journal of Communication*, 10, pp.838–859.
- Kemppainen, J., 2009. Kolme näkökulmaa independent-peleihin. In: *Game research yearbook*, pp. 49–56. Available at: <<http://www.pelitutkimus.fi/wpcontent/uploads/2009/08/ptvk2009-04.pdf>>.
- Kerr, A., 2006. *The business and culture of digital games: Gamework and gameplay*. Sage.
- Kerr, A., 2011. The culture of gamework. In: M. Deuze, ed. *Managing media work*. Sage.
- Kerr, A., 2013. Space wars: The politics of games production in Europe. In: N. Huntemann and B. Aslinger, eds. *Gaming globally*. Palgrave Macmillan, pp.215–231.
- Kerr, A., 2017. *Global games: Production, circulation and policy in the networked era*. Routledge.
- Kultima, A., 2015, Defining game jam. In: *Proceedings of the Foundations of Digital Games Conference*.

- Kultima, A., 2015, September. Developers' perspectives on iteration in game development. In: *Proceedings of the 19th International academic Mindtrek conference*. ACM, pp.26–32.
- Kultima, A., Niemelä, J., Paavilainen, J. and Saarenpää, H., 2008. Designing game idea generation games. In: *Proceedings of the 2008 conference on future play: Research, play, share*. ACM, pp.137–144.
- Lawson, B., 2006. *How designers think: the design process demystified*. Architectural Press.
- Lipkin, N., 2013. Examining indie's independence: The meaning of 'indie' games, the politics of production, and mainstream cooptation. *Loading... Journal of the Canadian Game Studies Association*, 7(11), pp.8–24.
- Manson, C., 1985. *MAZE: Solving the world's most challenging puzzle*. Henry Holt & Company.
- Martin, C.B. and Deuze, M., 2009. The independent production of culture: A digital games case study. *Games and Culture*, 4(3), pp.276–295.
- Melissinos, C. and O'Rourke, P., 2012. *The art of video games: From Pac-Man to mass effect*. Welcome Books.
- Mehrabian, A., 1971. *Silent messages*. Wadsworth.
- Michael, D., 2003. *Indie game development survival guide*. Charles River Media.
- Moor, J., 1985. What is computer ethics? *Metaphilosophy*, 16(4), pp.266–275.
- Namco, 1980. *Pac-Man* [game]. Namco.
- Nieborg, D.B., 2011. *Triple-A: The political economy of the blockbuster video game*. PhD, University of Amsterdam. Available at: <<http://dare.uva.nl/record/1/345555>>.
- O'Donnell, C., 2014. *Developer's dilemma: The secret world of videogame creators*. The MIT Press.
- Parker, F., 2013. Indie game studies year eleven. In: *Proceedings of DIGRA 2013: DeFragging game studies*.
- Parker, F., 2013. An art world for artgames. *Loading... Journal of the Canadian Game Studies Association*, 7(11), pp.41–60.
- Pink, S., 2013. *Doing visual ethnography*. Sage.
- Ruffino, P., 2013. Narratives of independent production in video game culture. *Loading... Journal of the Canadian Game Studies Association*, 7(11), pp.106–121.
- Sandovar, A., 2015. Cultural narratives in game design. In: *Proceedings of FDG 2015 conference: Papers from the doctoral consortium*. Monterey, CA, FDG.
- Schön, D.A., 1983. *The reflective practitioner: How professionals think in action*. Basic books.
- Spalding, N.J. and Phillips, T., 2007. Exploring the use of vignettes: From validity to trustworthiness. *Qualitative Health Research*, 17(7), pp.954–962.

Taito, 1978. *Space invaders* [game]. Taito.

Team Silent, 2001. *Silent Hill 2* [game] Konami Computer Entertainment.

Thompson, J.B., 1995. *The media and modernity: A social theory of the media*. Stanford University Press.

Van Roessel, L. and van Mastrigt-Ide, J., 2011. Collaboration and team composition in applied game creation processes. In: *Proceedings of DiGRA 2011 conference: Think, design, play*. August, Utrecht, Netherlands: Digital Games Research Association.

Visser, F.S., Stappers, P.J., Van der Lugt, R. and Sanders, E.B., 2005. Contextmapping: Experiences from practice. *CoDesign*, 1(2), pp.119–149

Wang, C., and Burris, M.A., 1997. Photovoice: Concept, methodology, and use for participatory needs assessment. *Health Education & Behavior*, 24(3), pp.369-387.

Whitson, J.R., 2012. *Game design by numbers: Instrumental play and the quantitative shift in the digital game industry*. PhD. Carleton University.

Whitson, J., 2013. The 'console ship is sinking' and what this means for indies. *Loading... Journal of the Canadian Game Studies Association*, 7(11), pp.122–129.

Zaltman, G., 1997. Rethinking market research: Putting people back in. *Journal of Marketing Research*, 34(4), pp.424–437.

Zimmerman, E., 2002. Do independent games exist? In L. King, ed. *Game on: The history and culture of videogames*. Laurence King Publishing, pp.120–129.

CHAPTER 10

CRITICAL PRACTICES IN GAME DESIGN

JESS MARCOTTE AND RILLA KHALED

In response to the critical theoretical work of Dunne and Raby (2013), Jeffrey and Shaowen Bardzell asked “what is ‘critical’ about critical design?” As discussions about critical game design begin to emerge (Flanagan, 2009; Grace, 2014), we echo this question, asking “what is ‘critical’ about critical game design?” One possible way of studying critical practices in game design is by studying designers and their contexts, both in terms of where and how they create and the larger socio-economic and cultural contexts that surround them. To discover the answer to our question, we delve into the creative processes of game designers and attempt to uncover ways of accessing the tacit creative knowledge therein.

It is not enough for the proof to be in the pudding. Verbalizing tacit design knowledge is an ongoing problem, and one that is exacerbated in the consciously politicized context of critical game design. While we believe all acts of creation are political, whether they choose to affirm a status quo or critique it, critical game design engages with active questioning of the situations that surround designers. Our assumption, then, is that at some point during this process, gestures towards the critical must enter into the picture. As such, we set out to study game designers in the process of designing. In this paper, we discuss two experimental interventions which attempted to help designers articulate their tacit knowledge, we reflect on the strengths and weaknesses of these two interventions, and we share our experience with designing these kinds of process-focused experiments. In doing so, we lay the groundwork for future experimentation with critical game designers.

CONTEXT AND DEFINITIONS

To date, critical game design research, under a myriad of names, has lacked focus on in-situ praxis and process that is instructive for other designers, or how designers make decisions at a subconscious level based on experience and other factors that might come together to form their *designerly instincts*. In *Critical play*, Mary Flanagan (2009) ends by presenting two diagrams of design process, one based on how she views what she called the “traditional iterative game design model” and one with alterations based on tenets of critical play. Beyond the addition of values and a mention of diversity to the design model for critical play, the two processes are identical. The key question is how Flanagan and others design specific games rather than how they think games in general ought to be designed. The boundaries of what is *critical* are in constant flux and today’s critical design might become the status quo tomorrow.

Designers writing about their own work must avoid looking only inward. Lindsay Grace's (2010) chapter on critical gameplay, for example, focuses primarily on his own work but presents it largely without context, leaving unexamined their impact on players, with little mention of the process of their creation. Even in later work, Grace (2014) appears to adopt a somewhat narrow position on critical games, focusing more on description of what they can be through referring to the works of a handful of designers, rather than on nuanced examination of how such design activity takes place. Maybe it is the case that these two processes, regular game design and critical game design, are only different in terms of whom they are designed for and which values are imparted, yet one would expect that the critical game design process is rather more complex than what is presented.

Our solution for interrogating these processes is to focus closely on the process of making as a way of thinking through what is occurring in critical game design. Matt Ratto's (2011) work on critical making, for example, focuses on the design process in academic group contexts. Based on the theme of the conferences that he takes his workshop to, Ratto develops group design exercises. The two examples that he discusses in particular are an early experiment involving simple robots that could draw, and a slightly more developed one involving networked flowers made from simple craft materials. For Ratto, thinking-through-making is the crucial component; he is not concerned with the resulting objects or what may be learned in retrospect. Likewise, Schön (1983, p.79) connects design process and learning, taking the position that it is possible to learn about design and tacit knowledge from observing process. His work involving the observation of an architectural school and an exchange between the master architect and a student provided inspiration for a focus on tacit design knowledge. Similarly, Matt Malpass's (2013) work with critical designers of design objects also provides an excellent precedent for engaging in these sorts of conversations about process. Although the conversation format is effaced within the resulting article, the notion of asking practitioners to reflect on their work as they see it is one that we have taken up in these design experiments.

If we look to the related field of interaction design, there are developing concerns around the notion of the critical, and there is a wealth of knowledge to draw upon, ranging from the specific practice of critical design, which challenges the status quo around the design of everyday objects (Dunne and Raby, 2013) to related practices such as speculative design, which is design that imagines possible futures (Auger, 2013), ludic design, which is an approach that aims to design for the activities that humans engage in for enjoyment and in our leisure time (Gaver, 2009), and critical making, explained above (Ratto, 2011). In their work on critical design, Dunne and Raby talk about "designs that are critical." Those of us interested in game design must talk not only of *critical games* or *critical play*, but instead of games that are critical, opening up the discussion to games that share the characteristics that we consider critical without necessarily being labeled as such by their creators. We understand *critical game design* or *game design that is critical* as design work that interrogates the medium of games itself, the cultures that surround it, and social and political situations that are of concern to the designers.

METHODS

What the critical game design literature leaves open is how we go about the practice of making critical games, how this process is shaped and informed as it is happening. Because we understand *game design that is critical* as being a complex, connected and contextual phenomenon, for us to deeply engage with its critical qualities, we need to examine game design work as it is taking place, and not in the abstract. Within the game design literature, there is a precedent for studying game creation in situ. In addition to the design research work of Ratto and Schön, a number of game scholars have taken up

the study of process, such as Wilson's reflection on designing *B.U.T.T.O.N* (2011), Holopainen, et al.'s (2010) model of experimental game design and Khaled's (2012) classroom design approach around muse-based game design.

Building on the existing approaches of Ratto, Schön, Wilson, Khaled, and Holopainen, et al., we sought to explore how to best articulate the tacit processes at work in the design of games that are critical. We did so by means of two interventions, where the second intervention was informed and designed around the results of the first. In our first intervention, participants were asked to spend a week designing around prompts which we provided. In our second, participants were asked to engage with other designers about works-in-progress that would have existed without their participation in our intervention. For both the former and the latter, we used thematic analysis to treat the data and our approach to the analysis has been largely essentialist and realist, as well as inductive (as defined by Braun and Clarke, 2006) although we seek to consider how these results might apply more broadly to a larger socio-cultural context.

The designers that we considered are Pippin Barr and Dietrich Squinkifer.¹ These designers now both work in and around Montreal, Canada, although at the time of the study Squinkifer was residing in Vancouver, Canada.

We begin by presenting one game that each designer has made. These particular games were chosen because they are representative of similar currents of thought and themes which can be found throughout their respective bodies of work. Pippin Barr's (2015a) *A series of gunshots* highlights his critical engagement with gun violence in games (as well as part of a larger social issue) and with game design best practices, resisting the urge to cater to accepted wisdom about how to treat player agency. Dietrich Squinkifer's (2014b) *Quing's quest VII: The death of videogames* takes on gamer culture's exclusionary practices as well as game aesthetics and gender-related questions.

A SERIES OF GUNSHOTS

This game is a sequel to *What we did* (Barr and Khaled, 2015b), a two-player game in which the players appear guilty of an unspecified crime and appear to be on the run. In *What we did*, players are given controls but not told what they do, and these controls are context-specific in the different vignettes of the game. Play can go on indefinitely, as it is possible to revisit the same locations, and players can build their own meaning through a repetition of actions so long as players do not choose the one game-ending option, "giving up." It is the action found in the giving up vignette, along with the stark, grayscale visual style, that Barr and Khaled (2015a) have carried over into *A series of gunshots*.

With no avatar and only one action available (other than closing their browser), players press any key and each time witness a flash of light accompanied by the sound of a gunshot in a window that they have had no hand in choosing. There is no context for the series of gunshots in each vignette except the architecture of the buildings and the darkness signaling that it is nighttime. At the end of the game, the screen goes black. This is also a game intended to be played once (cache and cookie-clearing aside). Returning to the game page still leads to the starting splash screen, but trying to start the game leads to the message "game over."

1. Our first experiment featured five designers, but we have decided to focus on two designers in particular for the purpose of this chapter.



Figure 1. A vignette from *A Series of gunshots* from <http://www.pippinbarr.com/games/aseriesofgunshots/>

The relationship of the player to the gunshot is ambiguous—the player definitely triggers the shot, but they are not the shooter. Barr (2015) says of that decision:

I had a build that included a mouse click to trigger the shots as well, but it quickly became obvious that that has too much implied directed agency (you click somewhere specific) which messes with the ‘involved and not involved’ feeling I want the game to have. The fact it’s any keypress (again, not, like the spacebar only to avoid the sense of having a specific agency, a trigger) makes your involvement both critical (it’s the only thing that makes the gun go off) and abstracted/distant.

Barr also notes that he wanted to avoid anything that might feel like a reward. *A series of gunshots* is a deft, focused critique of gun violence and the act of shooting in games, which Barr in turn says “is not unconnected” to shootings and gun violence out in the world.

QUING'S QUEST VII: THE DEATH OF VIDEOGAMES

In reaction to online harassment, Sandel (2014) launched Ruin Jam 2014, inviting the game creators of the internet to ruin games, listing just a few of the myriad ways that games are being ruined or could be ruined, such as:

'Forced Diversity', i.e. Minority characters with agency [...] People who make or talk about games having social and/or love lives [...] SJWs', which stands [sic] 'Social Justice Warriors'. It's bad to be this for some reason [...] People calling things that aren't games. The criteria for what a game is has yet to be disclosed," "Not being able to jump, shoot or be killed [...] Criticism or satire of existing game franchises.

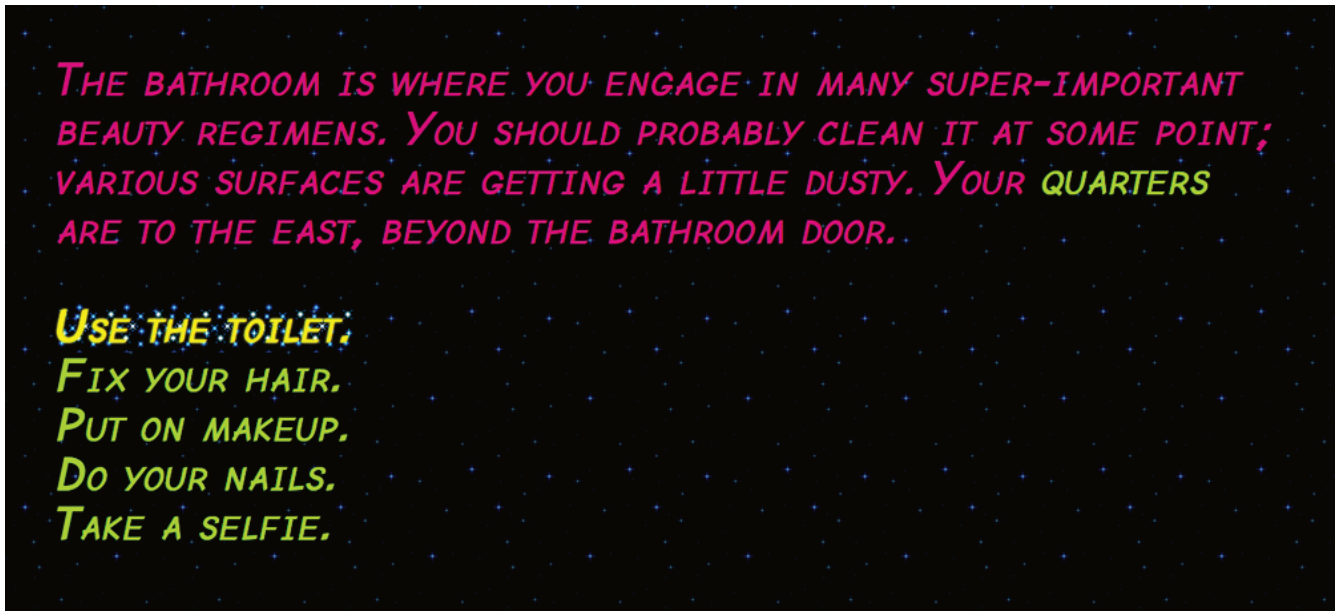

Figure 2. A screenshot from Quing's quest VII: The death of videogames by Dietrich Squinkifer.

Quing's quest VII: The death of videogames by Dietrich Squinkifer (2014a) was created for Ruin Jam. This game is a reaction to a particular situation at a particular time, but it also points to long-standing and ongoing issues in the culture around games, issues of identity, and current best-practice norms in the mainstream games industry.

Its aesthetic, combining sparkly html links with a background of twinkling stars and elevator music, as exemplified in Figure 2, is both playful and nostalgic and the overall tone of the game is similarly nostalgic and self-aware. There is also a sense of elegy for those voices who were so put-upon and mistreated by a culture and industry that didn't want them that they left. In a blog post introducing the game, Squinkifer (2014b) describes the game as: "a silly, over-the-top power fantasy, wherein you play a monarch of mysterious and indistinct gender exiled from their home planet" with "music, sound effects, incisive social commentary, old-school adventure game references, a cute genderfluid pirate non-player character, a working toilet, and glitter."

Identity politics are a central theme in this game. The average mainstream game features as its main character and is directed towards the demographic of the thirty-something cisgendered heterosexual male. In *Quing's quest VII: The death of videogames*, we play "the most gorgeous person of mysterious and indistinct gender in the universe," and are able to participate in customizing that identity through a variety of choices that includes appearance, but identity interacts in much more complex ways than

that within the game. The player is invited to ask themselves who games are for, what the term gamer means, and who should be allowed to make games:

‘Gamers’. That’s what the misogynerds started calling themselves, once they invaded your planet. To make it worse, they act as if this is the way it’s always been, as if Videogames was a planet that they alone discovered, as if your people hadn’t been there first. (Squinkifer, 2014a.)

Specific actions in the game speak to identity politics. For example, the player can take a selfie in the bathroom of their ship. Much has been made of the role of the selfie in the performance of identity, but the modern selfie remains at times an object of ridicule, a low art or a narcissistic act.² The popular perception seems to be that teenagers use the selfie to explore self-identity, but within some queer communities on the internet, the selfie is not only an exploration or an expression of identity, but an act of resistance (Wilson, 2013). Being unabashedly visible in cultures that participate in your erasure, consciously or not, is a powerful critical act.

FIRST INTERVENTION: RESPONDING TO DESIGN PROMPTS

This first intervention was an attempt at triggering a critical design process in designers for the purpose of analyzing how critical game design takes shape in its initial stages. We focused on individual process, as revealed through the notebooks, documentation of works-in-progress, and interviews which form the data corpus for our thematic analysis. Processes related to game design should of course retain their creative aspects, rather than being a series of recipe-like instructions to follow. As such, we chose, through these experiments, to foreground the tacit knowledge of game design without delineating specific design-related methodologies.

To begin, before providing the designers with a common prompt, we asked them to complete a five-question interview. The first question asked them to identify themselves and their relationship to the game-making communities around them, situating them in terms of how they viewed themselves. The second question asked about how they approached a new task or project, and what they viewed as the sources of their ideas and decisions. The third question asked about their extant process-recording habits, such as whether they kept any notes already, in what form and with what frequency. The fourth question asked participants to identify recurring themes, subjects in their work, and whether they felt they had a design philosophy. The fifth question asked them to reflect on a particular project that they had completed and think about how it unfolded.

Following these initial questions, all participants were given a design prompt based on VNA cards (Kultima, 2007) and two modifiers (additional questions aimed at inspiring thought) based on a set of conversation starting cards (Tabletopics.com, n.d.) and asked to attempt to design something around these prompts over the course of a week. The prompts and modifiers were drawn randomly from these sets of cards by us. The VNA prompts were: “devote”, “grid” and, “black and white”, while the modifiers were “what obligation do you believe you have to your country?” and “which other culture would you choose to be born into?” Each participant provided us with at around two pages of notes, often punctuated by small sketches on the page. Additionally, participants annotated their notes with explanations that would be understandable to others such as the researchers who would be handling them. The majority of the notes and recordings about process that we received after the end of the experiment were in words with a few sketches. The notes were often spatially organized in some way,

2. For an excellent discussion on the history of self-representation and discussions of the modern filtered self (cf. Rettberg, 2014).

such as visually-connected maps from brainstorming sessions. The one exception was one participant, a visual artist, who provided us with a digital drawing representing their response to the prompts.

After the one-week design period, participants shared their design records and were given another interview. The interview was based on just three questions, but follow-up questions allowed participants and researchers to direct the conversation toward particular sites of interest. The first of these three questions asked participants about their feelings regarding the design and whether recording their process affected the design. The second question asked whether the design that they had come up with seemed in-line with their design philosophy or any recurring themes in their work, and if there were any changes they would make to line the design up better with those themes or that philosophy. The third question asked whether there appeared to be a difference between how they had initially described their process and how their process had played out over the course of the experiment.

What follows is a summary of the results for the two participants whom we have decided to focus on in this first intervention.

CASE 1: PIPPIN BARR

In the pre-experiment interview questions, Barr positioned himself as “a game maker, and I often say ‘experimental’ in there too,” noting that he has also been labeled as a “minimalist” and a “comedian” in terms of the kinds of games he makes. He mentions that he is “returning to full academic life, working in the Depart [sic] of the Design and Computation Arts at Concordia University, having been chiefly a teacher (at the Master’s level) of game design and related subjects at a number of international universities.”

In terms of where he fits into surrounding gaming communities, Barr notes that “never quite managed to integrate into the physically present scenes” around him—something that he intends to do now that he is in Montreal, but as he adjusts to his new teaching position, this is something that he had at the time deprioritized. Currently, Barr’s sense of community comes from online, and specifically Twitter, where he “[prefers] to just broadcast weird poems, but it definitely makes [him] feel closer to a general idea of people making games around [him].” He also relates to games and game makers through the judging that he does for competitions such as the Independent Games Festival (IGF) and IndieCade, both festivals which are aimed at bringing game creators together. Now that he is in Montreal, he feels that the Technoculture, Art and Games lab (TAG) is another link to the gaming community, but that he has been absent from there so far.

The way that Barr outlines his process involves multiple steps on a fairly small scale. He is careful about over-thinking his ideas: “usually I find that a lot of ‘thinking’ and ‘designing’ time kind of kills it for me.” His first step is usually either to have an idea or to look into his backlog of ideas, and he does not usually take any breaks between projects: “I’m very much of the philosophy of starting to think about a new project the instant I release the previous one.” When starting to work on an idea, he’ll open up a text file, jot down some initial notes, and then start mocking up some screens for it in a tool like Pixen, or “to immediately grab a template project from whichever engine [he is] using and start actually building bits and pieces.” Barr calls most of his ideas “incredibly simple,” although the authors would argue for the sophistication of their execution and a strong sense that many of them have been crafted with a lot consideration and care.

Barr thinks that his “history as an academic and especially [his] background in philosophy and computer science have determined a lot of what [he ends] up being naturally interested in pursuing.” However, he “[does not] know where the ideas come from. Sometimes just at random, sometimes out of something [he] read in a book, sometimes as an extension of something [he] saw in another game or piece of media, or even in one of [his] own games. It doesn’t feel like there’s any stable pattern. It does seem to [him] that they’re always very simple though, like ‘one liners’ in terms of what [he] might call a ‘purity’ of concept—it’s possible to conceptualise the whole thing at once, rather than needing to really break it down.”

He records aspects of his process in a number of ways, such as “[a] text file in Evernote which has to-do lists for implementation details, plaintive short-essays about my thinking (usually concerns and worries) about the process, screenshots of interesting bugs or visual effects or reference points from other media[...] my phone to note down new game ideas as they come along[...] a paper notebook which I doodle in incessantly (somehow most often at talks), and sometimes end up making notes on game designs, mostly writing along with sketches of what screens might look like.” The more complex an idea, the longer Barr spends with it, and the more he writes about it.

Thematically, Barr makes his work anti-violence where possible, only including violence if it is necessary to make a point about it or a related theme. Barr considers some of his work meta, as in “games about games.” As to whether he has a specific philosophy, Barr is not sure, but notes that he likes to make things that he finds “amusing, or, occasionally, important” and enjoys making games that make him “laugh at the idea of them.”

When asked to reflect on a particular game, Barr chose to think about *A series of gunshots*, which is described in detail above. Although he has to make decisions during his process, and is at times limited by what he is able to code, Barr says that overall his games remain “locked-in” in terms of the idea and many aspects of the aesthetics. The notion of the “ground truth” of a game is central to Barr’s process.

Barr’s experiment notes came in two forms: one is a set of handwritten notes with some sketches, and the other is a text file, organized by date with explorations of a variety of ideas and associations. He chose to ignore the modifier sentences because they felt like they would take the design to less interesting places, given other experimental constraints. There is a clear connection to Barr’s previous work, such as his explorations of *Breakout* (1976) and the idea of using the mechanics of classic games, including chess (perhaps linked to the prompts of “grid” and “black and white”). According to his notes, time constraints were also an issue that caused Barr to privilege some directions for thought over others – for example, he tended to think about how to use “ready-made game parts” as vehicles for conceptual thinking. Reading Barr’s notes, we see him approach the prompt from different angles, such as looking up definitions in the dictionary, looking to other games as references, and free association.

Our conversation afterwards took place as an email thread. As was the case with the other experiment participants, Barr did not end up with a single design, but rather multiple avenues that could be explored further. The experiment contained aspects that both were and were not familiar to him. He initially described the experience as follows:

I’m not normally ‘assigned’ a design constraint of course, for one thing, but nor am I normally in the position of writing my design documentation ‘for’ another reader, which I was of course aware of as I was writing about this challenge. On the other hand, the material produced is accurate in the sense that it does mirror the kinds of documentation/ideas I produce when thinking about a new design at least for some projects. I

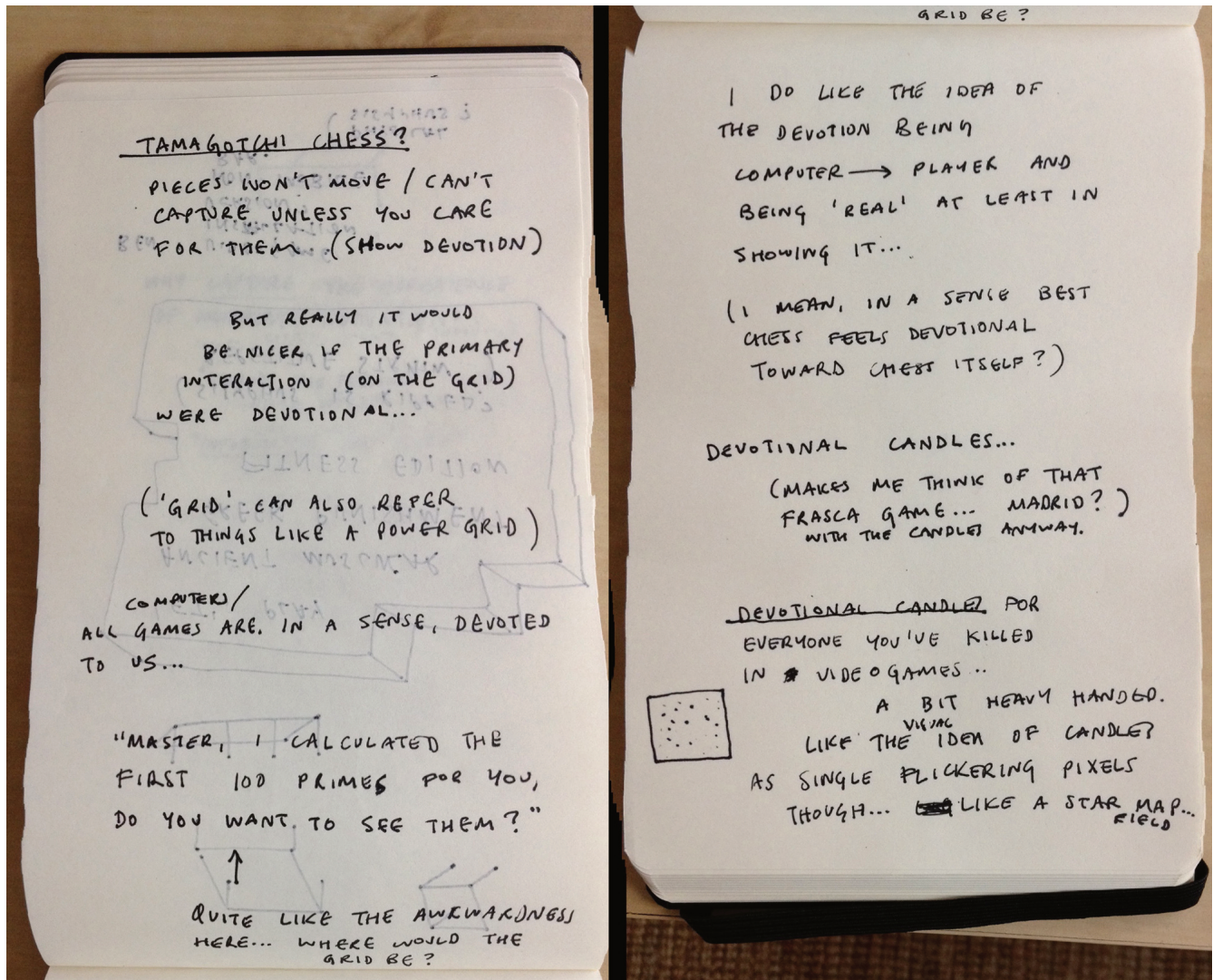

Figure 3. Pippin Barr's notebook pages from the experiment.

often find myself doing streamofconsciousness [sic] writing about the subject, making associations, perhaps drawing small sketches of screens (though I didn't do that in this case), so it felt fairly authentic as far as being 'what I would do' in this situation. Although I was aware of the idea that someone else would read the writing, it didn't feel like it had a too major effect on how I wrote... I was probably a little more discursive and explanatory than I might have been if it were only notes for myself, a little more 'narrating' of the idea process rather than perhaps just writing down bullet points to remind me of subjects. On the other hand, I do write rambling notes to myself at times as well, so.

One major difference in the process for Barr was that normally, his ideas come to him in ways that feel almost fully-formed. In this case study, the idea "came from outside me in the form of the constraints and that very much changed my relationship to the idea," referring to the constraints that we, the researchers, provided in the structure of the experiment. This altered his process: "with the constraints, the process was much more 'now I'm going to sit down and design a game about X' which is not at all what I ordinarily do." While Barr thinks that the process he went through is on some level still reflective of "how his brain works," he is careful to note that "there are cases where I've been closer to the idea of 'design a game about X' and I think I've almost universally struggled in that scenario."

Based on his responses to the initial questions, we asked Barr about his experience teaching game design and how one can teach or explain the creative leaps that occur during design. Conceding that the kinds of games that he makes may be more artsy than what is generally taught in game design classes, Barr spoke about his teaching approach:

There are all these books that are about how to design a game (Fullerton etc. etc.) but none of them really match at all with how I feel about the process because they're all about making a different kind of game.

I think postmortems are a pretty great option (I'm a fan in general of studio model teaching where the instructor is largely there to 'model' a practice rather than to somehow transmit or translate it). It feels like a more honest way of communicating about design, notably an honesty about not necessarily know how the whole thing works, not treating it so much like a science as some people can be keen to do (because it's reassuring to think it's like that I'd imagine).

As a game maker who creates, teaches and writes academically, Barr's responses are at an intersection between different modes of thought. As with all the designers who participated in our experiment, Barr's thinking on the topic of teaching game design diverges from notions of best-practice, as does his work. For Barr, games are often a way of thinking about games, and this is one area where his work contributes to design that is critical, even in this brief and mediated experience. The experimental context felt mediated to Barr and altered his normal modes of work, but his explorations still show an engagement with what he earlier calls the "meta." This feeling of mediation was, however, of concern to us because it altered Barr's typical process of design.

CASE 2: DIETRICH SQUINKIFER

In the pre-experiment interview questions, Squinkifer traces their trajectory in games and connects it with other aspects of their identity:

I have been actively engaged in game-making since 1999, and released my first game in 2002, while still a high school student. I worked professionally as an employee of multiple games studios between 2006 and 2010, but left the industry in order to more effectively pursue game-making as an individual artistic practice. Since then, I have received an MFA from UC Santa Cruz and have had my work shown in gallery exhibitions and nominated for awards from major organizations including the IGF and IndieCade. Although I have been making games for a long time, I consider the most interesting work in the field right now to be coming from DIY, beginner-focused "altgames" communities; in particular, the work of historically marginalized groups such as the queer/trans community and people of colour. (I consider myself part of both groups.)

On first steps when making games, they say that they keep a list of ideas in their phone to refer to, and that, as a general rule, they work on one project at a time. As such, any new idea that Squinkifer has while working on a current project is added to the list. They often combine a number of items into one game idea. When they begin working on an idea, they set up "[their] coding environment and [start] working on art assets at the same time as [they] begin "pre-production" tasks such as initial design and writing," which "helps bring the game idea to life."

In terms of keeping a record while they work, they say that, beyond the list of ideas that they keep in their task manager, they use text files, Google docs, or even Twine files, regardless of whether the game is "a Twine game." Although they occasionally freewrite in notebooks, it is rare that they will look at these notes again unless typing them. Many of the art assets in Squinkifer's games are made directly on the iPad or computer, and it is rare for them to sketch on paper.

A recurring theme in their work is “Social awkwardness, particularly around identity and failure to be normative” and they consider their work to be both funny and serious. Squinkifer tries to balance comedy and drama, because “comedy without drama is toothless, whereas drama without comedy is overwrought.” They try to let the project shape what it feels that it needs to be without paying mind to the preconceived notions of what a game ought to be, although the tools that they use also help to shape their work.

The particular project that they chose to discuss in terms of its development is *Tentacles growing everywhere* (Squinkifer, 2015), which they describe as coming “from an idea [they] had to create a queer version of the *Babysitters Club*.” After encountering Naomi Clark’s (2014) *Consentacle*, they began thinking about “sex and gender as experienced by aliens: if alien sex exists, then so must alien puberty.” Although they originally considered creating a graphical adventure game, they eventually chose to create a Twine novella instead to better express the character’s inner thoughts, as well as for the opportunity to “[mess] around with custom CSS in Twine 2 and created a theme reminiscent of 2000s-era Livejournal” and say some things about online blogging and journal culture at the time, which was noted in our discussion to be of particular importance to those who felt marginalized offline.

Squinkifer’s experiment notes took the form of a Google doc which is very clearly annotated. In contrast to Barr, Squinkifer was drawn to the modifiers before the prompts. They suggest that the subject matter of the modifiers is fresh in their mind due to recent travels to Japan and the Philippines. Identity is an important theme in Squinky’s work, and they consider a different dimension of identity here, one related to being a person of colour with ties to multiple different countries with distinct cultural expectations. They begin with a series of questions and bullet-point notes, such as:

what is my country even? Canada? the Philippines? Iran?

I’ve never been to Iran because there’s a nonzero chance I could be imprisoned/killed in going there

what obligation do I have to a country that should rightfully belong to the First Nations?

what obligation do I have to a country ravaged by colonialism?

what obligation do I have to a country that would kill me for being who I am?

They go on to acknowledge the complexity of these issues and thoughts, by noting that their thoughts about Iran are similar to the types of reactions from white Islamophobes that make them bristle. Next, they discuss cultural rules and differences that they have noticed based on their recent travels.

Turning their thoughts back to the prompts, they think about the multiple meanings of the term “black & white,” which reminds them of their game, *Dominique pamplemousse* (Squinkifer, 2013), but also of “black & white thinking.” Their first thought is about the gender binary, and how they experienced its effects in relation to class in the Philippines, and they observe that, in comparison to Canada, the Philippines “seems to be both more genderfluid and gender-rigid.” They consider the reaction of a young relative and the potential absence of cultural signifiers such as “butch lesbians” and note that people seemed more likely to take clothing and hair as a gender signifier. Squinkifer then wonders about the intersection between gender and class in this context, and whether the wealthy are more likely to be gender-conforming, having seen more gender non-conformity in impoverished contexts.

Squinkifer felt like the prompts provided allowed them to explore ideas that were in-line with recurring themes that could be found in their work. They did mention that these ideas were “more on the serious end of the spectrum,” but that there is also a lot of potential for comedy in “ideas of culture and not fitting into particular cultures even though you’re supposed to” and “having your multiple cultural identities be in conflict with one another,” issues that they felt were underexplored in games. They expressed concern over the current trend of “empathy games,” saying that “[they’re] trying to do less of that—focus[ing] on one aspect of marginalization to the exclusion of all others but not really dealing with the subtle interactions, the intersections [...] conflicting ideas.” Their hope is that game creators and players will move beyond empathy games and explore these intersections. Overall, they felt that the resulting designs were in too much of an initial stage to consider any changes they might make to them.

When asked about how their process this time around differed from how they had described it, they noted the lack of visual elements and preliminary tinkering that they tend to normally do. They feel that this may have been because the ideas felt too preliminary, or they had not yet been inspired to work on the visual aspects of the game.

After this, Squinkifer notes that they stopped working on the project for a time, returning a few days later to “[think] about the other words in the prompt, hitting upon something closer to an actual game design.” The word grid has them considering bingo cards, and they wonder whether this would make a good Twine game. They think of the word “devote” in terms of devoting time to aspects of one’s identity, and identify some possible outcomes: “spreading yourself too thin, or focusing on some parts of your identity at the expense of others.” They end on a list of possible identities: “Canadian, Filipino, Persian, queer, artist, geek,” and before they have the chance to take the project up again, the one-week period of the experiment is over.

Our second interview with Squinkifer took the form of a Skype call, and we talked at length about the performativity of the experiment. They felt like they were participating in an experiment rather than actually designing. Coming off of a long period of travel, they felt that they were in a period of creative downtime, which they also attributed to “the natural creative ebb and flow of where [their] brain is.” As a result, they also felt like they would usually have gotten more done in a similar length of time. They felt the performative aspect of the experiment strongly, noting:

I would brainstorm notes, and then feel the need to annotate the notes I made. Reading stuff in my own head, I make associations with words and notes I write down, but once I’m aware that someone else is going to read this and have to try and understand my process, I feel the need to go back and explain exactly what I was thinking at the time.

Asked whether this was positive or negative, Squinkifer said that it was not necessarily negative, and that “the process of performing the creative process is in itself potentially a viable, interesting art form.” They were also reminded of autobiography and documentary. They were unsure as to whether how they work was “something that they could express in words.” This reaction was similar to Barr’s, and one that we chose to take up in designing our second intervention.

REFLECTIONS ON THE FIRST INTERVENTION

Even though the game designers who participated in this intervention were not being observed directly, just knowing that they were observing themselves to report back to others and that others would be attempting to understand their process through their reporting changed the way that

participants worked. For example, most participants felt the need to annotate, or write in a different style than they normally would for increased clarity. This was perhaps suggested to them by the description of the experiment, which invited them to include any additional notes interpreting or explaining their notes, but it did not occur to us that they would attempt to write these notes as they were designing rather than providing explanatory notes after the fact.

This intervention was also complicated by the fact that the design prompts were ours rather than something of the participants' own construction. Our aim was to give everyone the same starting point, but this simply is not how most designers work unless perhaps participating in a themed game jam.

Having asked our participants about how they view their role in the communities that surround them, our first intervention also did not make use of those communities. While some aspects of design are solitary and may not be easy to share, designers and artists do not work in a vacuum. We considered experimental designs that could leverage the connections between solo designers or collaborators.

DESIGNING STUDIES THAT ARE PROCESS-FOCUSED

Unsurprisingly, finding ways to study the tacit knowledge that designers bring to the table is a complex prospect that is made more so by attempts to translate or observe it. What we have found in this experiment and in these case studies is that there is a tension in the transmission of design knowledge: for those creators who are not already concerned with recording their process in some way, the designed context of the experiment, which is an artificial one, alters the experience some degree. Recording and explaining the process, or even just knowing that someone else will be looking at one's records and trying to understand them causes a change in approach and leads to a certain sense of performativity.

One participant, Squinkifer, noted, "One thing that I do when I have a game idea is that I like to talk it over with other artistically inclined friends, people that I trust and respect." They speculated about whether recording such conversations or deliberately staging them would lead to an interesting outcome. Perhaps this is one possible avenue for further exploration, either with designers coming in with existing designs that they are eager to discuss and get feedback on, or asking creators to work from a same prompt before coming together to talk.

We also asked Barr what he thought some potential solutions might be to mitigate the effects of observation and impact the organic process of design as little as possible. Barr suggested that, in a longer experiment, perhaps one where designers are asked to see a project through the entire development process, from designing to making, the performative aspects of the experiment might somewhat fade, but that, however, "I don't think you'd ever entirely shake it just because there's a strong drive (for me) to be entertaining or more articulate or something, and I think that would be there whenever writing documentation, choosing what to present in terms of imagery or prototypes etc." This is in line with the observations of Squinkifer, who noted:

I'm not entirely sure it's possible to document [designers] creative processes that they have alone by themselves in quite the same way. It's going to be performative [...] turning anything into a documentary is going to make the process somewhat more performative and artificial, and there's going to be editing [...] there's always going to be editing to make things parsable to a general audience.

Barr also suggested finding “designers who [...] do documentation naturally and perhaps use that as a data source instead, so that it isn’t inflected by having been part of a specific design experiment.” He expressed the possibility of getting into the habit of releasing his design notes in the future for anyone who might be interested. We made it known that we thought this would be a great boon to other designers and researchers.

Given that it may be impossible to wholly mitigate the artificiality or performative aspects of this kind of experiment, another possibility is to embrace them. By manipulating different aspects of the conditions under which we ask participants to create, perhaps we can highlight different aspects of the design process and find other tactics that help reveal the tacit knowledge that we are concerned with. It remains worthwhile to think about individual process over generalized methods.

As with the first experiment, the format of this intervention was inspired by Schön’s (1983) work in the *Reflective practitioner* in that we wished to make visible the tacit knowledge of practitioners and to acknowledge them as experts on their own processes. By tying the discussions to work that existed independently of the intervention, we created a context in which designers could talk with designers, about design, but not entirely divorced from action or the practice of design.

Bringing designers together in a clearly-delineated timeframe to talk about existing projects made the expectations for this intervention much clearer and made less demands on our participants’ time overall. Having designers talk together rather than working on a project for an experiment in isolation also helped direct the conversations to sites of interest for them, which lead to subjects that might not otherwise have been broached in a more formal interview or in a one-designer-on-one-researcher context.

At this point, we decided that further interventions which placed designers in conversation with one another while keeping in mind the design work itself would be fruitful. In terms of the data collected, the set was limited due to the scheduling factors that have already been discussed. As such, an ideal version of this experiment would include more sessions, to allow the designers to develop their conversations further.

SECOND INTERVENTION INTO NATURAL PROCESS

In our first intervention, participants were asked to design a game over the course of a week in response to prompts that we provided. We hypothesized that there was some part of their process where critical design concepts and thought entered into the picture in some form, given that we judged their existing work to be frequently critical in some form. The second intervention is a direct result of what we were able to observe from the results of the first intervention and feedback from participants. With input from our participants, we designed an experiment around projects in various stages that they would have completed regardless of participating in our intervention.

The design process that ended up being observed was not a natural critical design process for either of those designers, so what is critical in critical design slid away from us. We think of these designers as having critical design features somewhere in their design process, so it is important not to interfere with that process. This is why we did a second experiment. We designed this experiment through direct feedback of what the designers thought would be a helpful approach.

Our questions of concern for this second phase were scoped out using the results of the first phase. Our methods in the first phase introduced an artificiality to the design problem. This led to conditions

where our participants were unable to work according to their usual habits. Instead, they tried to work according to prompts that we had given them and to make their processes understandable to us. As such, our results were far more mediated than we would have liked, and less true to how these designers actually work when left to their own devices. Due to the methodological shortcomings of our first study, we decided to undertake a second round of study, this time attempting to circumvent the artificiality of the previous task. The first study resulted in our participants talking about design but not acting on design, which felt artificial to them and to us. Rather than asking them to undertake and discuss projects that would only be for the purpose of the data (as in the first experiment), we instead focused on their existing work—specifically, works-in-progress that would have existed with or without our intervention. As previously mentioned, the data was qualitatively analyzed using an inductive essentialist and realist thematic analysis approach.

These process-oriented discussions featured three designers, Jess Marcotte, Dietrich Squinkifer and Pippin Barr. Due to sudden schedule changes and personal factors, we managed to get our participants together for two one-hour sessions. The first session was largely introductory, and participants discussed their current projects and plans, and the software and tools they were using, as well as factors affecting their work such as stress and other demands on their time. During the second session, which is perhaps more directly relevant to the discussion at hand, we asked participants to directly engage with the subject of critical game design practices: “What [are game designers doing] when [they] make games about critical subjects? Are [they] actually doing anything different design-wise?” As it turns out, both designers were skeptical about the notion of critical game design as a practice separate from thoughtful or considered design practices: “I guess I think you *could* actively do ‘critical game design’, remembering to take a critical stance toward everything, thinking about your ‘message’ all the time... But a lot of the time it seems like that comes out more or less naturally through ‘thoughtfulness?’” (Barr, emphasis in original). In response, Squinkifer noted, “it would feel really unnatural to me to design in that way.”

Where Flanagan’s (2009) work falls short, these designers suggested, was in terms of her ability to communicate what she means about critical design: that it would perhaps be useful to designers who wished to engage in critical practices to have a guide, based on descriptions by designers who engage in a consciously critical practice. We then asked what “unthoughtful” or “unconsidered” game design might look like to them:

I guess it’s ‘impossible’ if we’re literally meaning you don’t think at all. But I guess I think of thoughtless design as being going with the utterly traditional / standard / taken-as-read design practices, genre conventions [...] Which [...] I guess we all have a bit of that in us (Barr)

I don’t think there’s such a thing as thoughtless/unthoughtful game design — it’s more about what values are prioritized [...] Like, in the industry, there’s a lot of thought being put into design, but it’s in the service of goals like ‘what will make money’ and ‘what will please the player and make them feel good’ (Squinkifer)

This aligns with the idea of a spectrum rather than a binary along which thoughts about design and values that designs espouse exist. The designers did not really think that thoughtless design was the issue, but that what separated the work of designers that they viewed as critical from other work was “what [they] are thinking about.” On this spectrum, we have the status quo, or received notions of best practice, and we have all that differs from that status quo to varying degrees, and in varying ways.

The second session connected this spectrum to demands from the capitalist status quo to be productive according to certain metrics, especially ones of economy and efficiency for both game

production and day to day life under this system. It is interesting to note that these two words can in some contexts be used interchangeably, such as when “economy of words” means that we use an efficient number of words to get a message across. Having recently given a talk at the Game Developers’ Conference in San Francisco, Squinkifer discussed their speaker evaluations and what the crowd of this industry-focused conference expected from their talk: “the audience was expecting answers and clear ‘takeaways’, which I couldn’t really give them, at least not to the extent they wanted.” To them, this signaled a discomfort with ambiguity and unsettled thought that could not be immediately (or efficiently) operationalized. During our discussion, participants came to the agreement that they believed that capitalism is also the political status quo within western culture. Furthermore the ideas that Squinkifer was engaging with, such as queer failure, awkwardness, and disruption, which do not easily align with efficiency or monetization, were as a result considered distinctly political and fringe by our participants. In our conversations, the consensus was that the status quo is frequently what is considered apolitical, despite the fact that such a state of affairs is deeply political. Squinkifer noted, “the conditions under which games are produced is different if you have some of the economic pressure relieved or if there was never a chance to make any money off of a project to begin with.”

Similarly, Barr took up this idea of “unsettledness” or ambiguity in thinking through what it meant to engage in critical design practices: “I think ‘critical’ is more about process perhaps, about asking questions through design rather than assuming answers [...] And definitely tied to capital there – answers sell, questions don’t really so much.” While capitalism desires authoritative answers and, consequently, risk reduction, “those things are often at odds with the complexity of these chosen subjects” (Barr). Engaging with critical subjects and values for these designers means comfort with ambiguity – to do otherwise and to claim to have all the answers is naive at best, and can be offensive.

After some discussion about the role of humor in social change and which subjects would be particularly difficult to design around, we asked our participants to consider once more whether or not there was such a thing as critical design and how they approached their design process in terms of “getting across” meaning. Although our participants continued to privilege questions over answers, and were reluctant to give a sweeping, authoritative answer, the key theme that arose in this part of the discussion was that of reflection. Noting that one could think critically about anything, Barr talked about the force of intuitive design decisions (where one is not altogether sure why one has made a decision) followed by careful reflection, critically examining whether an intuitive move is “working,” echoing Schön’s (1983) observation that design process for expert designers can happen automatically and requires introspection to be articulated (for example, to transmit knowledge to a student). Squinkifer noted that one of the roles of playtesting was to test and fine-tune intuitive design moves to see what message was being received by players and to determine whether this was the desired effect. Barr suggested that being able to talk lucidly about one’s work – what one has done and why—after the fact might be a more important aspect of “game design that is critical” than the original act of creation. It may indeed be the case that what can be considered critical is largely shaped by the paratexts and discussions that surround an object.

REFLECTIONS ON THE SECOND INTERVENTION

On the one hand, justifications after the fact are a pitfall of talking about design with designers without observing their process. However, having our participants verbalize their thoughts both about the factors affecting design and their knowledge of their own context and about a project while they were in the midst of working gave us insight into how they see themselves and critical game

design. These discussions differ from post mortems and writing about process after the fact because the projects, being in-progress, were still being shaped. At this point in the creative process, there were still design decisions being made, and such discussions about process partway through a project could then be compared to the final outcome. Our intervention also asked participants to engage directly with questions about critical game design, allowing them to share insights that they have gleaned from their experience.

On their own, these conversations do not get at the tacit process-focused knowledge that we are seeking. For one, more time is needed. Ideally, scheduling more of these kinds of sessions as well as perhaps scheduling co-working sessions would be one avenue for future study, particularly in regards to designers communicating design knowledge amongst each other.

Additionally, observation of process and other experiments are needed in order to triangulate different sources of knowledge. To gain access to the tacit knowledge of design, we will need to design experiments that do not get in the way of our participants' usual workflow, but that also draw out knowledge that is usually left unspoken, or considered "instinctual" or coming from long experience with the medium.

DISCUSSION

The implications of these studies in exploring design process are of concern for researchers who might wish to study any number of crafts and creative processes. In our first intervention, we wanted to be able to compare data from different designers. For that reason, we decided to provide every designer with the same exercise: the same prompts, the same instructions, and the same amount of time in which to work. This proved to be a misstep because in taking interest in where and how critical game design work happens, creative processes themselves become a chief concern. These processes are highly individual and context-dependent. Our intervention changed the context, and thus altered the process that we were trying to observe.

In our second intervention, game designers were asked to talk to each other about their projects and about what they consciously think about what critical design is (and indeed whether it exists at all). Although part of the focus was on works-in-progress that existed without our intervention, there is still the issue of mediation. Though the projects were still in stages that were mutable and in no way final, there is a distance between the design process itself and speaking about it with other creators. In finding words to talk about the creative process, there is mediation and the danger of justification after the fact. There is also the question of whether designers actually make decisions for the reasons that they think that they do.

From our interventions, it is clear that there are certain factors which must be considered further. As previously mentioned, the context of creation matters, and this can be subdivided quite finely. For example, whether a designer is working at a jam, in their own time on a personal project, as part of an art practice, as part of a studio (of varying sizes), or as part of an academic context (as a teacher, researcher or student) matters. Additionally, the cultural context within which all of these roles exist is also of import. Relevant questions include what sort of government and economic system the designer is working under, what other identities they hold, what the community around them is like, and many others.

A variety of experimental methods with the same participants will be needed to further explore and triangulate knowledge about critical game design. What is tacit about expert design knowledge is

unspoken precisely because it is difficult to verbalize. Schools everywhere continue to teach design, so this knowledge is being transmitted in some way. Further experimentation with methodology is needed to create situations in which interventions do not obfuscate the very knowledge that we are seeking.

CONCLUSION

Exposing design processes for others to learn from is helpful to designers and academics alike, as well as for that hybrid figure, the designer-scholar. As creative output continues to gain legitimacy as an approach for creating new academic knowledge, it is more important than ever to be able to make visible the hows and whys, the successes and failures, and the instructive messiness of our design decisions. In adopting a broadened purview, we gain access to a nuanced landscape of design that is critical, which enables us to put these works in conversation with one another. In this chapter, we report on the results of examinations of critical design process. We ran two rounds of this experiment with varying degrees of mediation and two different tactics for helping our participants verbalize the tacit knowledge of design. There are many possible answers to the question of where the critical part of critical design occurs or begins to be part of the process, and those answers are likely to vary according to the designer.

What these interventions remind us is that the critical is contextual. It takes time to develop work that is in conversation with larger traditions—time that was unavailable in the case of our first intervention—and it is these larger traditions, mediums or bodies of work that help creators and designs take aim what is ultimately a moving target: the affirmative state that leads to a critically-engaged creative piece. “Design that is critical” is context-dependent. A designer steeped in context may not always be easily able to verbalize or transmit information about that same context, in part because some aspects of it become internalized, and so it may feel as if these aspects are simply a part of their identity as a creator, or knowledge that “everyone” who occupies a similar role has or ought to have. This is one of the traits of an expert—they live with knowledge of particular contexts, have read and otherwise experienced related materials to the point that they probably do not remember how they came to learn it. When translated through the human brain, this is perhaps one of the sources of intuited decisions and the tacit knowledge which we are seeking to draw out. We first attempted to observe these designers work in their context with some intervention. We then reminded them of the existence of that context—with the intent of making the familiar visible again—by placing them in conversation with each other. Although further conversations and interventions are needed, these gestures suggest future ways forward.

The two interventions that we have used here highlight some pitfalls to avoid in future experimental design, as well as providing specific analysis of the work of two designers. Our goal was to draw out concrete design knowledge, but we have also made the case for the need for process-focused research into critical game design and game design more generally, despite the difficulty of accessing such knowledge.

BIBLIOGRAPHY

- Auger, J., 2013. Speculative design: Crafting the speculation. *Digital Creativity*, 24(1), pp.11–35. DOI=10.1080/14626268.2013.767276.
- Bardzell, J. and Bardzell, S., 2013. What is “critical” about critical design?. In: *Proceedings of the SIGCHI conference on human factors in computing systems, CHI’13*. pp.3297–3306

- Barr, P. and Khaled, R., 2015a. *A series of gunshots* [game]. Pippin Barr, Montreal, Canada. Available at: <<http://www.pippinbarr.com/games/aseriesofgunshots/>>.
- Barr, P., 2015. *A series of shots in the dark*. Pippin Barr, Available at <<http://www.pippinbarr.com/2015/10/26/a-series-of-shots-in-the-dark/>>.
- Barr, P and Khaled, R., 2015b. *What We Did* [game]. Pippin Barr, Montreal, Canada. Available at: <<http://www.pippinbarr.com/2015/02/03/what-we-did/>>.
- Braun, V. and Clarke, V., 2006. Using thematic analysis in psychology. *Qualitative Research in Psychology*, 3(2), pp.77–101.
- Bushnell, N. Bristow, S. and Wozniak, S., 1976. *Breakout* [game]. Atari, Inc.
- Clark, N., 2014. *Consentacle* [game]. Naomi Clarke.
- Dunne, A. and Raby, F., 2013. *Speculative everything: Design, fiction, and social dreaming*. Massachusetts: The MIT Press.
- Flanagan, M., 2009. *Critical play: Radical game design*. The MIT Press.
- Gaver, B., 2009. Designing for homo ludens, still. In: T. Binder, J. Löwgren and L. Malmberg, eds. 2009. *(Re)searching the digital Bauhaus*, Springer, pp.163–178.
- Holopainen, J., Nummenmaa, T. and Kuittinen, J., 2010. Modelling experimental game design. In: *Proceedings of DiGRA Nordic 2010: Experiencing games: Games, play, and players*. Available at: <<http://www.digra.org/wp-content/uploads/digital-library/10343.48507.pdf>>.
- Khaled, R., 2012. Muse-based game design. *DIS* June 2012. ACM, pp.721–730.
- Kultima, A., 2007. *VNA Card Set*, [online] AaKoo's game lab. Available at: <https://gameslices.files.wordpress.com/2008/05/vna_casualgames_cardset_2007.pdf> [Accessed 14 Dec. 2015].
- Grace, L., 2014. Critical games: Critical design in independent games. In: *Proceedings of DiGRA 2014*. Aug 3–6, 2014, Snowbird. DiGRA.
- Grace, L., 2010. Critical gameplay: Design techniques and case studies'. In: K. Schrier, ed. 2010. *Designing games for ethics*. IGI Global, pp.128–141.
- Malpass, M., 2013. Between wit and reason: Defining associative, speculative, and critical design in practice. *Design and Culture*, 5(3), pp.333–356.
- Ratto, M., 2011.,Critical making: Conceptual and material studies. *Technology and Social Life, The Information Society: An International Journal*, 27(4), pp.252–260.
- Rettberg, J.W., 2014. *Seeing ourselves through technology: How we use selfies, blogs and wearable devices to see and shape ourselves*. Palgrave Macmillan.
- Sandel, C., 2014. *Ruin Jam 2014 - itch.io*, [online]. itch.io, Available at: <<http://itch.io/jam/ruinjam2014>>.

- Schön, D.A., 1983. *The reflective practitioner: How professionals think in action*. Basic Books.
- Squinkifer, D., 2013. *Dominique pamplémousse*. [game]. Dietrich Squinkifer.
- Squinkifer, D., 2014a. *Quing's quest VII: The death of videogames*. [game]. Dietrich Squinkifer.
- Squinkifer, D., 2014b. Quing's quest VII: The death of videogames!, [Blog] *Squinky.me*, Available at <<http://squinky.me/2014/09/01/quings-quest-vii-the-death-of-videogames/>>.
- Squinkifer, D. 2015. *Tentacles growing everywhere*. [game]. Santa Cruz: Dietrich Squinkifer.
- Tabletopics.com, n.d.. *Original edition | Conversation starters | TableTopics*, [online] Available at <<http://www.tabletopics.com/Original-Edition-Cube>>.
- Wilson, D., 2011. Brutally unfair tactics totally OK now: On self-effacing games and unachievements. *Game Studies*, 11(1).
- Wilson, G., 2013. *Selfies of the marginalized body: Acts of resistance, disruptions of the expected*, [Blog] *living not existing*.

ABOUT THE AUTHORS

Petri Lankoski (D.Arts) is an associate professor at Södertörn University where he teaches game development and game research. His research focuses on games and emotions, game character design, and game design. Lankoski also develops games as part of the research. His publications include *Character-driven game design* (Aalto University, 2010) and *Game research methods: An overview* (co-edited with Staffan Björk, ETC Press, 2015) as well as two collections in Finnish about experience design and location aware services: *Ihminen, paikka ja aika* (2002) and *Henkilökohtainen navigointi* (co-edited with Leeni Kirvesniemi, TUP, 2003).

Jussi Holopainen (PhD) is a senior lecturer in games computing, University of Lincoln, UK. His current research interests include experimental game design, empirical studies of game design practices, and games for behavioral change. He has authored or co-authored several pieces on game design, most notably *Patterns in game design* (Charles River Media, 2004), and was a co-organizer of the *Game design research symposium* at ITU Copenhagen in 2004.

Jon Back (PhD) is a play and game designer, and associate senior lecturer at Uppsala University. His focus is on how to create engagement, feelings and experiences in public settings. He's been working with many game formats, both inside and outside of computers. He is highly inspired not only by classic game design, but also by areas such as live action role-play, child's play, storytelling, and street performance. He is a researcher and a practitioner, having published both board games and card games, as well as performed playful performance art and organized many kinds of game events.

Laureline Chiapello is a PhD student in game design at the Université de Montréal and a lecturer at the Université du Québec. Her research focuses on game designers: their everyday practices, but also their education, knowledge and roles in the video game industry. She worked in collaboration with multiple designers from a variety of Canadian companies on game projects post mortem. She also acquired some expertise in casual gaming as a junior designer in a French company and participated in the anthology about new gaming trends entitled *Social, casual and mobile games* (2016).

Karin Coninx (PhD) is a professor at Hasselt University, Belgium, where she teaches courses in computer science and human-computer interaction. Karin Coninx is leading the Human-Computer Interaction Group of EDM (Expertise Centre for Digital Media, a research institute of Hasselt University), Dean of the science faculty and Director of the Doctoral School for Sciences and Technology. Her research interests include user-centered methodologies, (multimodal) interaction in virtual environments, haptic feedback, technology-supported rehabilitation and CareTech, serious games, mobile and context-sensitive systems, interactive (ubicomp) work spaces, and the model-based realization of user interfaces. She has over 300 publications in human-computer interaction, some of which are in application domains such as rehabilitation.

Paul Coulton is a professor of speculative and game design in the open and exploratory design-led research studio Imagination Lancaster. He uses a research through design methodology in the

creation of novel, hybrid, physical/digital interactive games, playful experiences, and artefacts. Paul has been a pioneer in new forms of gaming and evaluation methods and is currently working on methods related to speculative design and design fiction. Most recently he has published book chapters on *Playful and gameful design for the internet of things*, *Designing mobile and ubiquitous games and playful interactions*, and *Digital cartography for the playable city*.

Joris Dormans (PhD) is an independent game developer, international game scholar, and lecturer at Leiden University. He has been designing and studying games professionally for over a decade specializing in emergent gameplay, design patterns, procedural content generation, and structuralist analysis of game narratives. As part of his PhD research he created the machinations framework that foregrounds the underlying structures in game economies that contribute to a game's emergent behavior. Together with industry veteran Ernest Adams he co-authored the advanced game design textbook *Game mechanics* that further expands and refines the machinations framework.

Emmanuel Guardiola (PhD) is game director and expert in game design methodology. He has contributed to more than 30 major titles in the game industry, for independent studios and publishers (*Prince of Persia*, *Tom Clancy*, and *Far Cry* franchises). He drives research on player psychological profiling through gameplay, at the CEDRIC lab of the CNAM (Paris), and at the Cologne Game Lab, where he is a professor. He was one of the key creators of the Master game design training at the French National school of games and new media (ENJMIN).

Alan Hook (MA) is a researcher in new media and play at Ulster University within its Centre for Media Research. His research focuses on play as a form of interaction and how play can be used as a means to understand complex problems. He has published research on alternative reality games, video games and play, and has also produced a number of mobile, physical and mixed reality games as pieces of research. Alan is currently studying towards a PhD in Design at Lancaster University which focuses on designing games and digital toys for other species, to promote inter-species empathy and understanding.

Annakaisa Kultima (MSSc in theoretical philosophy) is a game researcher at the University of Tampere Game Research Lab and Aalto University School of Arts, Design and Architecture. Her research focuses on exploring games as created and she has published on various game related topics since 2006. Kultima teaches game design and design research in Finland and Sweden and is an active member of the game industry ecosystem. She runs a non-profit organization *Finnish game jam*, supporting the game development hobby and organizes game jams as well as other game events in Finland and elsewhere. She is also creating games as a hobby and playful experiments within her research projects.

Rilla Khaled (PhD) is the director of the Technoculture, art, and games (TAG) research centre at Concordia University, and an associate professor of design and computation arts at Concordia University. Her research and practice has centered on the design of learning and persuasive games, interactions between games and culture, and practices involved in emerging forms of game design. She was a lead designer for the award-winning learning game *Village voices*, developed as part of the EU FP7 SIREN project on games and conflict resolution. She was also the lead designer for the game *Words matter*, targeted towards dyslexic players and supported by the EU FP7-funded ILearnRW project. Her current projects include Canadian FRQSC-funded Speculative play and reflective game design, concerning tackling ambiguous subject matter, empowering the perspectives of players, and drawing together learning and experimental games.

Steven Malliet (PhD) is an assistant professor at the University of Antwerp and at the Leuven University College of Arts, Belgium. He has a Master's degree in communication studies and in computer science and obtained his PhD with a study on videogame effects. His research targets the game play experience, with a focus on perceived realism, moral involvement and playing style. He is also a designer of serious games and has been involved in several research-through-art projects. He is the co-editor of two books (*Vice city virtue: Moral issues in digital game play* and *The borders of subcultures: Resistance and the mainstream*), and has published in journals such as *New Media & Society*, *Computers in Human Behavior*, *Cyberpsychology & Behavior*, and *Presence: Teleoperators & Virtual Environments*.

Jess Marcotte is a game designer, writer, intersectional feminist, and PhD student at Concordia University who has worked on games such as *In tune: A game about navigating consent*, *Rustle your leaves to me softly*, and *The truly terrific traveling troubleshooter*. Through these projects, they explore their interests in accessibility, diversity and provoking meaningful conversations through their work. Their other research interests include critical and speculative design, feminist making, and praxis-focused research. Their PhD at TAG, under the supervision of Rilla Khaled, will explore what it means to digitize entangled analog and embodied experiences from an intersectional feminist design perspective. They are a founding member of Tweed Couch Games and were one of the co-directors for Critical Hit 2015.

Niels Quinten (PhD) is a game design lecturer and research coordinator of the play&game research group at the Leuven University College of Arts, Belgium. He received his PhD in audiovisual and visual arts at Hasselt University performing practice-based research on the creative design of physical rehabilitation games. His work has been published through conferences such as *Games, learning and society* Conference and the International Conference on Entertainment Computing, and he has exhibited internationally such as at the DiGRA 2015 Blank Arcade Exhibition. He currently explores how artistic experimentation and creative freedom can drive the design of applied games.

Alyea Sandovar (PhD) is a creative director at Tint Hue, a digital research consulting agency in Amsterdam, Netherlands. She works with non-profits and universities to provide playful workshops, user research and testing, and research design consultation. Her game research focuses on production studies. She makes use of visual methods to examine the relationship between independent game designer's games and their personal background. She has a particular interest in the design of media, its creators and the influence these creations have on culture at large.

Christopher W. Totten is an independent game developer, game design instructor, and founder of Pie For Breakfast Studios. He is a former chair of the Washington DC chapter of the International Game Developers Association and founder of the Smithsonian American Art Museum Indie Arcade. Totten is an active writer in the game industry, with articles featured in industry journals, chapters in several academic publications, and two books: *Game character creation in Blender and Unity* (Wiley 2012) and *An Architectural approach to level design* (CRC, 2014.) He is also the editor of *Level design: Processes and experiences* (CRC 2016.) He has also spoken at GDC, GDC China, *Foundations Of digital games* (FDG), *Digital Games Research Association* (DiGRA) conference, and *Games for change* and displayed his games at MAGFest, The Smithsonian Innovation in Art event, and Baltimore Artscape. He has a Masters Degree in Architecture from The Catholic University of America in Washington, DC.

Annika Waern (PhD) is a research by design academic with a background in computer science and human-computer interaction, who has dedicated the last ten years of her life to understanding games and play, and more specifically, pervasive games. These are games that are played in the physical

world, often with the aid of mobile and ubiquitous technology. Annika holds a professorship at Uppsala University. She has an extensive background in research leadership in collaboration with industry. She acts as editor for several international journals including editor in chief for *ToDIGRA*, *transactions of the Digital Games Research Association*. She frequently participates in programme committees for scientific conferences in the fields of human-computer interaction and game studies. She is co-author of *Pervasive games: Theory and design* (with Montola and Stenros, 2009).

ABOUT THE ETC PRESS

The ETC Press was founded in 2005 under the direction of Dr. Drew Davidson, the Director of Carnegie Mellon University's Entertainment Technology Center (ETC), as an academic, digital-first (but not digital only), open access publishing imprint.

What does all that mean?

The ETC Press publishes academic and trade books and singles, textbooks, academic journals, and conference proceedings that focus on issues revolving around entertainment technologies as they are applied across a variety of fields. Our authors come from a range of fields. Some are traditional academics. Some are practitioners. And some work in between. What ties them all together is their ability to write about the impact of emerging technologies and its significance in society.

In keeping with that mission, the ETC Press uses emerging technologies to design all of our books and Lulu, an on-demand publisher, to distribute our e-books and print books through all the major retail chains, such as Amazon, Barnes & Noble, Kobo, and Apple, and we work with The Game Crafter to produce tabletop games.

We don't carry an inventory ourselves. Instead, each print book is created when somebody buys a copy.

The ETC Press is also an open-access publisher, which means every book, journal, and proceeding is available as a free download. We're most interested in the sharing and spreading of ideas. We also have an agreement with the Association for Computing Machinery (ACM) to list ETC Press publications in the ACM Digital Library.

Because we're an open-access publisher, authors retain ownership of their intellectual property. We do that by releasing all of our books, journals, and proceedings under one of two Creative Commons licenses:

- **Attribution-NoDerivativeWorks-NonCommercial:** This license allows for published works to remain intact, but versions can be created.
- **Attribution-NonCommercial-ShareAlike:** This license allows for authors to retain editorial control of their creations while also encouraging readers to collaboratively rewrite content.

This is definitely an experiment in the notion of publishing, and we invite people to participate. We are exploring what it means to "publish" across multiple media and multiple versions. We believe this is the future of publication, bridging virtual and physical media with fluid versions of publications as well as enabling the creative blurring of what constitutes reading and writing.